

Visium HD Fresh Frozen Tissue Preparation Handbook

Introduction

The Visium HD Spatial Gene Expression workflow is designed to analyze mRNA in tissue sections derived from fresh frozen (FF) tissue samples. This workflow is facilitated via the CytAssist instrument, which enables the capture of ligated probe products onto the Visium HD Slide. A single CytAssist run accommodates up to two stained tissue slides (tissue placed on a blank slide) as sample input. Proper tissue handling and preparation techniques preserve the morphological quality of the tissue sections and the integrity of mRNA transcripts. Maintaining tissue adhesion and high-quality RNA is critical to assay performance.

This FF Tissue Handbook provides guidance on:

- Best practices for handling tissue samples and blank slides before and after cryosectioning
- Freezing and embedding tissue samples prior to cryosectioning
- Cryosectioning of tissue samples and placement of sections on blank slides
- RNA quality and optional tissue morphology assessment
- Hematoxylin & eosin (H&E) staining and imaging
- Immunofluorescence (IF) staining and imaging

Additional Guidance

This protocol is compatible with most human and mouse tissue types. Additional optimization may be required for the preparation of specialized tissues, such as tissue with high fat content. See the 10x Genomics Support website for additional resources, including a list of tissues tested.

Contents

Handbook Overview and Navigation

Overview	4
----------	---

Visium HD Spatial Gene Expression Reagent Kits

Visium HD Spatial Gene Expression Reagent Kits	5
10x Genomics Accessories	6
Third-Party Items	7

Tips & Best Practices

General Reagent Handling	8
General Best Practices	8
Pipette Calibration	8
RNA Quality Assessment	8
Cryosectioning Temperature	9
Sectioning Speed	9
Section Thickness	9
Section Placement on Blank Slides	9
Practice Section Placement	10
Optional - Area of Interest Annotation	10
Handling Tissue Slides	12
Tissue Slide Incubation	13
Cassette Incubation	14
Reagent Addition to & Removal from Wells	14
Visium Slide Seal Application & Removal	16

1. Tissue Handling, Freezing, Embedding, Sectioning, Section Placement, and Quality Assessment

1.0 Preparation	23
1.1 Separate Tissue Freezing & Embedding	26
1.2 Simultaneous Tissue Freezing & Embedding	27
1.3 Cryosectioning	28
1.4 Section Placement	29
1.5 Tissue Block Storage and Tissue Slide Shipping	30
1.6 RNA Quality Assessment	31
1.7 Optional DAPI Staining for Tissue Morphology Assessment	33
1.8 Optional H&E Staining for Tissue Morphology Assessment	34

2. H&E Staining & Imaging

2.0 Overview	36
--------------	----

2.1 Preparation	37
2.2 Tissue Slide Preparation	44
2.3 Fixation	45
2.4 H&E Staining	46
2.5 Coverslip Mounting	48
2.6 Imaging	49
2.7 Coverslip Removal	49
2.8 Destaining	50
2.9 Permeabilization	52
3. IF Staining & Imaging	
3.0 Preparation	58
3.1 Tissue Slide Preparation	68
3.2 Fixation	69
3.3 Permeabilization	70
3.4 Immunofluorescence Staining	71
3.5 Immunofluorescence Staining - Fluorophore Conjugated Primary Antibodies	71
3.6 Immunofluorescence Staining - Primary & Secondary Antibodies	74
3.7 Coverslip Mounting	78
3.8 Imaging	79
3.9 Coverslip Removal	79

Troubleshooting

Handbook Overview and Navigation

Overview

This handbook describes sample preparation for the Visium HD Spatial Gene Expression workflow. Tabs on the right-hand side of the page denote different sections of this handbook.

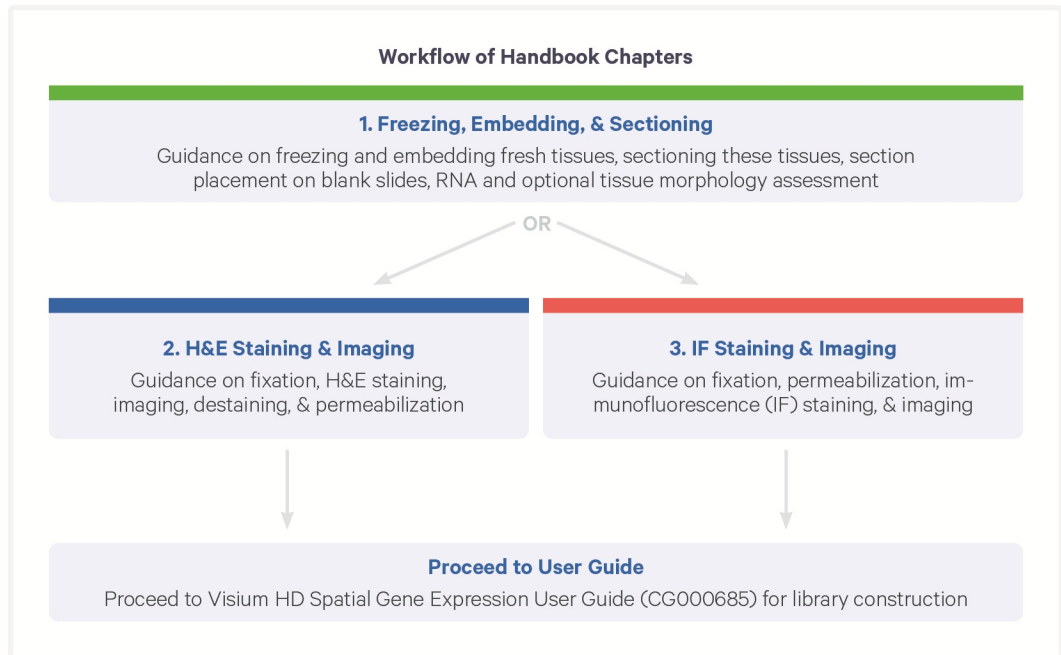

Visium HD Spatial Gene Expression Reagent Kits

Consult SDS for handling and disposal information

Visium HD Spatial Gene Expression Reagent Kits

Visium HD Cassettes, 6.5 mm, 4 rxns PN-1000669

Visium HD Cassettes, 6.5 mm 4 rxns PN-1000669 (store at ambient temperature)		
	#	PN
Visium 2-port Cassette S3, 6.5 mm		
Visium Cassette 2-port gasket, 6.5 mm	2	3001831
Visium Cassette Bottom	2	3001830
Visium Tissue Slide Cassette S3, 6.5 mm		
Tissue Slide Cassette Top	4	3001826
Movable Tissue Gasket 6.5 mm (preassembled with translator)	4	3001828
Movable Tissue Gasket Translator (preassembled with gasket)	4	3001927
Tissue Slide Cassette Bottom	4	3001825
Visium Slide Seals, 12 pack	2	2000283



*The Visium HD Workflow is run with Visium Tissue Slide Cassettes S3 and Visium Cassettes S3. These are referred to as Tissue Slide Cassettes and Visium Cassettes in this document, respectively. Consult the Visium S3 Tissue Slide Cassette Assembly Quick Reference Card (CG000730) for assembly and disassembly information.

Visium 8-port Cassette S3, 4 pk PN-1000685

Visium 8-port Cassette S3 4 pk PN-1000685 (store at ambient temperature)		
	#	PN
8-port Gasket Top	4	3001827
Tissue Slide Cassette Bottom	4	3001825





A Visium 8-port Cassette S3, 4 pk (PN-1000685) must be purchased to perform antibody optimization prior to IF staining.

Visium Tissue Slide Cassette S3, 6.5 mm, 4 pk PN-1000684

Visium Tissue Slide Cassette S3, 6.5 mm 4 pk PN-1000684 (store at ambient temperature)		
	#	PN
Tissue Slide Cassette Top	4	3001826
Movable Tissue Gasket 6.5 mm	4	3001828
Movable Tissue Gasket Translator	4	3001927
Tissue Slide Cassette Bottom	4	3001825





One additional Tissue Slide Cassette (Visium Tissue Slide Cassette S3 6.5 mm, 4 pk PN-1000684) is required for each processed Tissue Slide during IF staining.

10x Genomics Accessories

Product	#	Part Number (Kit)	Part Number (Item)
10x Magnetic Separator	1	1000499 (Visium CytAssist Reagent Accessory Kit)	230003 or 2000431
Low Profile Thermocycler Adapter	2		3000823

Third-Party Items

Successful execution of the Visium HD workflow requires third-party reagents, kits, and equipment in addition to those provided by 10x Genomics. All third-party reagents and consumables should be obtained prior to starting this workflow.

Consult the Visium HD Spatial Gene Expression Protocol Planner (CG000698, Rev B or later) for a list of the following third-party items:

- Additional reagents, kits, and equipment
- Tested pipette tips
- Tested thermal cyclers
- Tested blank slides



10x Genomics has tested all items listed in the Protocol Planner. Unless otherwise noted, 10x Genomics recommends using these items to ensure optimal assay performance. Substituting materials may adversely affect assay performance.

Tips & Best Practices

Icons



Tips & Best Practices section includes additional guidance



Signifies critical step requiring accurate execution



Troubleshooting section includes additional guidance



Indicates a version-specific update in volume, temperature, instruction, etc.

General Reagent Handling

- Fully thaw and thoroughly mix reagents before use.
- When pipette mixing reagents, unless otherwise specified, set pipette to 75% of total volume.

General Best Practices

- Best practices for handling any tissues include using sterile technique and nuclease-free reagents/consumables.

Pipette Calibration

- Follow manufacturer's calibration and maintenance schedules.

RNA Quality Assessment

- Assess RNA quality of the tissue block by calculating the RNA Integrity Number (RIN) of RNA extracted from tissue sections.
- Various factors could lead to variations in RIN scores, such as:
 - Specific tissue types
 - Tissue heterogeneity
 - Diseased or necrotic tissues
 - Sample preparation and handling

- Excess OCT
- Loading concentration or ladder errors on the RNA QC platform

Cryosectioning Temperature

- Cryosectioning temperature impacts tissue section integrity. Use a temperature setting of -20°C for the blade and -10°C for the specimen head.
- Temperature settings depend upon local conditions, tissue types, and the cryostat used. Settings should be optimized based on the quality of resulting tissue sections.
- During prolonged sectioning periods, allow the cryostat temperature to equilibrate by briefly closing the chamber.

Sectioning Speed

- Sectioning speed depends upon the desired thickness of the sections and the condition of the tissue. Harder and thicker sections require slow sectioning speed.
- Faster sectioning speed may lead to cracks or tears in the sections. Faster section speed may also damage the tissue block or cryostat.

Section Thickness

- Recommended section thickness for most tissue types is $10\ \mu\text{m}$, but tissues from $10\text{--}20\ \mu\text{m}$ are compatible with the assay. Tissues with higher fat content (e.g., breast tissue) may require sections closer to $20\ \mu\text{m}$.

Section Placement on Blank Slides

- After section placement, blank slides are referred to as tissue slides.
- Before section placement, draw an outline of the allowable area on the back of the blank slide to ensure compatibility with the Visium CytAssist instrument and Tissue Slide Cassette, as shown below. Example allowable area images below are not to scale.

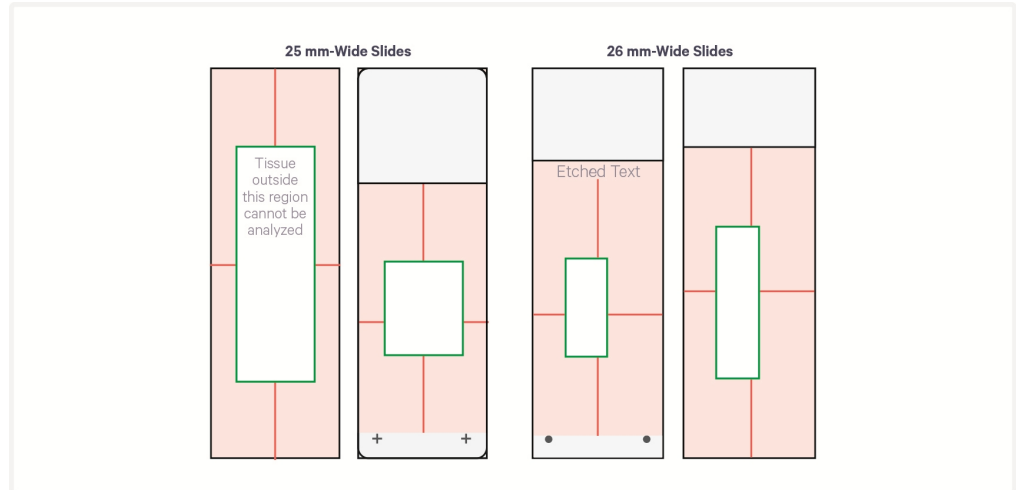

Consult the Visium CytAssist Accessory Kit Quick Reference Card (Document CG000548) on the 10x Genomics support website for complete instructions on determining allowable area. Consult the Visium HD Spatial Gene Expression Protocol Planner (CG000698) for a list of tested slides.

- Each tissue slide can only be processed with the Visium CytAssist instrument once.
- 10x Genomics recommends placing tissues with large amounts of connective tissue (like breast, skin, or colon) on Schott Nexterion Slide H - 3D Hydrogel Coated Slides (Schott North America, PN-1800434) to minimize risk of tissue detachment. Schott H slides may also be used if prior detachment has been observed with tissues of interest.

Practice Section Placement

- Practice correct section placement using nonexperimental blocks.
- Practicing section placement also allows for determining an ideal tissue thickness for the tissue type or block.
- Sections should be placed on the compatible blank slides listed in the Visium HD Spatial Gene Expression Protocol Planner (CG000698).

Optional - Area of Interest Annotation

If a tissue section does not fit completely within the Visium HD Slide Capture Area, a smaller area of interest (AOI) should be defined.

The AOI should be:

- Small enough to fit inside a well in a Tissue Slide Cassette gasket. Tissue outside of the gasket will not be processed during the assay workflow.
- Centered within the appropriate Capture Area size on the Tissue Slide Stage on the Visium CytAssist instrument.

Defining an AOI can occur after section placement by examining the tissue under a microscope or after H&E staining and imaging.

H&E Staining:

- Annotate the AOI using a marker on the back side of the tissue slide based on the assessment of tissue morphology from the H&E image. This annotation can serve as a reference for gasket placement when assembling the tissue slide in the Tissue Slide Cassette.
- Remove annotations with isopropanol or ethanol before loading the tissue slide onto the CytAssist instrument. Failure to remove annotations can lead to improper tissue detection, causing automatic tissue registration to fail. Should this occur, manual tissue registration on Loupe Browser will be required.
- When loading the tissue slide on the instrument, the pale eosin staining of the tissue area included within the gasket and the darker H&E staining of tissue areas outside the cassette will provide sufficient contrast to identify and align the correct tissue region on the CytAssist.

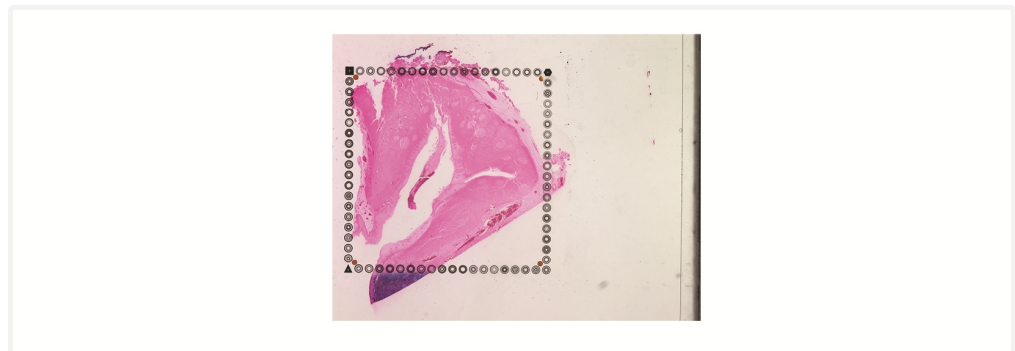

IF Staining:

- Remove annotations with isopropanol or ethanol before loading the tissue slide onto the CytAssist instrument. Failure to remove annotations can lead to improper tissue detection, causing automatic tissue registration to fail. Should this occur, manual tissue registration on Loupe Browser will be required.
- When loading the slide on the instrument, the gasket imprint marks the boundary of the tissue area and can be used to align the AOI on the CytAssist.

Handling Tissue Slides

- If a laboratory wipe is required, use 100% polyester lint-free laboratory wipes. Lens paper or non-lint free laboratory wipes are not suitable alternatives.

See Visium HD Spatial Gene Expression Protocol Planner (CG000698) for tested part numbers.

- When immersing slides in reagent, ensure all tissue sections are immersed.
- Maintain tissue slides in a mailer on dry ice after removal from the freezer. Do not remove from dry ice until ready to thaw slides on a thermal cycler during Tissue Slide Preparation.
- If placing in a slide mailer or 50-ml centrifuge tube after sectioning, mailer or tube should be pre-cooled to cryostat temperature for 10–15 min.
 - Immediately place storage container on dry ice for transport to a -80°C freezer for long-term storage.
 - Avoid tissue slides touching one another while in storage.
- Always wear gloves when handling slides.
- DO NOT touch the tissue sections on the slide.
- Minimize exposure of the slides to sources of particles and fibers.
- Keep the slide flat on the bench when adding reagents.
- Ensure that no absorbent surface is in contact with the reagents on the slide during incubation.

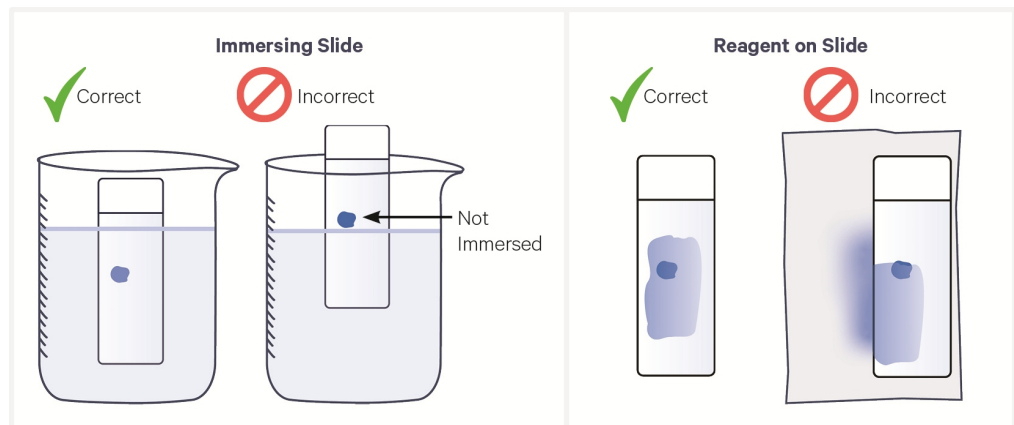

- DO NOT use a hydrophobic barrier (such as one applied by a PAP pen) on slides. These barriers may affect assay performance.

- Tissue slides may be annotated to highlight an AOI. See [Optional - Area of Interest Annotation on page 10](#) for more information.
- When imaging, avoid pressing down on the coverslip to ensure easy removal after imaging.

Tissue Slide Incubation

Incubation using a Thermal Cycler:

- Position a Low Profile Thermocycler Adapter on a thermal cycler that is set at the incubation temperature. Low Profile Thermocycler Adapter must come to temperature before placing tissue slide.
- Ensure that the Low Profile Thermocycler Adapter is in contact with the thermal cycler surface uniformly. Consult the Visium HD Spatial Gene Expression Protocol Planner (CG000698) for information on thermal cycler compatibility.
- Position tissue slides on the Low Profile Thermocycler Adapter with the side with tissue facing up.
- Ensure that the entire bottom surface of tissue slides is in contact with the Low Profile Thermocycler Adapter.
- DO NOT close the thermal cycler lid when incubating tissue slides.
- Allow Low Profile Thermocycler Adapter to cool before removing from thermal cycler.

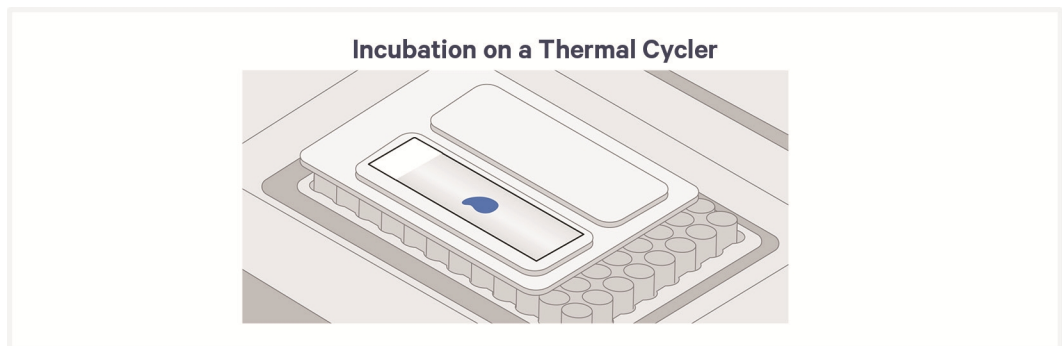

Incubation at room temperature:

- Place the Tissue Slide Cassette on a flat, clean, nonabsorbent work surface.

Cassette Incubation

Incubation using a Thermal Cycler:

- Position a Low Profile Thermocycler Adapter on a thermal cycler that is set at the incubation temperature. Low Profile Thermocycler Adapter must come to temperature before cassette placement.
- Ensure that the Low Profile Thermocycler Adapter is in contact with the thermal cycler surface uniformly. Consult the for information on thermal cycler compatibility.
- Ensure that the cassette sits flush with the raised portion of the Low Profile Thermocycler Adapter.
- Allow Low Profile Thermocycler Adapter to cool before removing from thermal cycler.

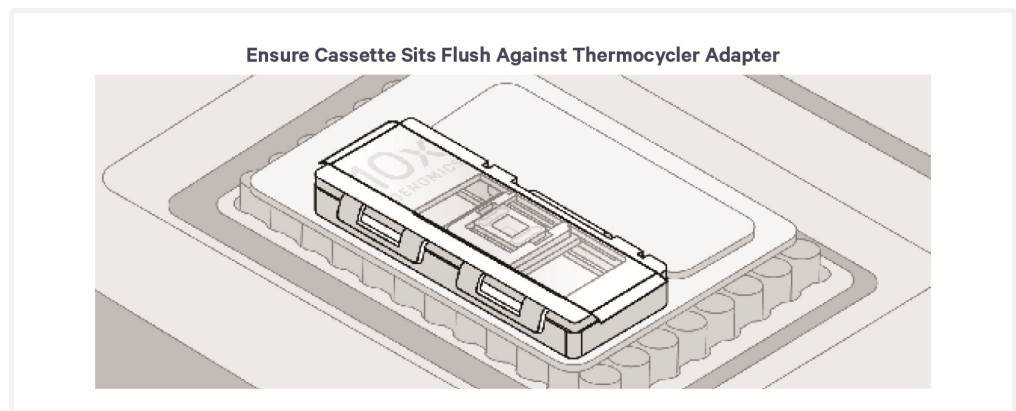

Reagent Addition to & Removal from Wells

Reagent Addition

- Assemble slide into the cassette flat on a clean work surface.
- Dispense and remove reagents along the side of the wells without touching the slide surface, tissue sections (when applicable), and without introducing bubbles.
- DO NOT forcefully insert pipette tip into well corners to avoid damaging the Visium HD slide.
- If applicable, perform washes next to the thermal cycler to avoid significant changes in temperature during washes.

- When processing two or more Visium Tissue Slide Cassettes, remove and add reagent from the first cassette before proceeding to the next cassette. Ensure tissue sections are always covered with reagent in between removal and addition steps to avoid drying out of tissue samples.



- Always cover the Capture Area or tissue completely when adding reagents to the well. A gentle tap may help spread the reagent more evenly.

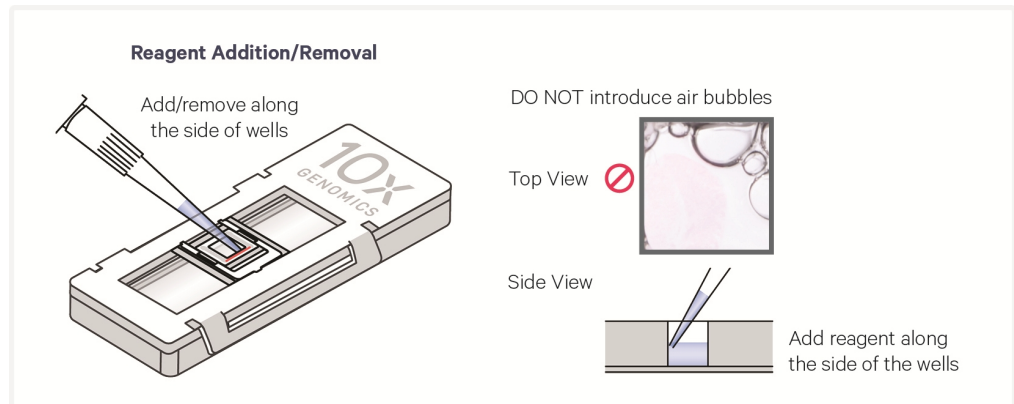

Reagent Removal from Wells

- Slightly tilt the cassette while removing the reagent.
- Place the pipette tip on the bottom edge of the wells.
- Remove reagents along the side of the wells without touching the tissue sections (when applicable) and without introducing bubbles.
- Remove all liquid from the wells in each step. To ensure complete removal, check the bottom of the well by tilting the cassette slightly. A meniscus at the bottom of the well will indicate the presence of liquid in the well. Repeat removal steps until no reagent remains.

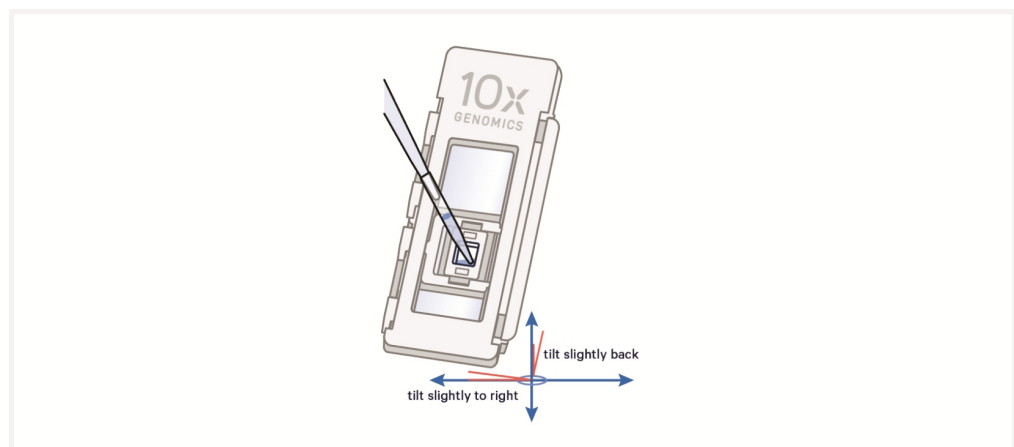

Visium Slide Seal Application & Removal

Application

- If applying a Visium Slide Seal to a Tissue Slide Cassette, the seal must be cut in half lengthwise. Cut the seal as shown in the image below. Six pre-cut seals per tissue slide are necessary for this assay.

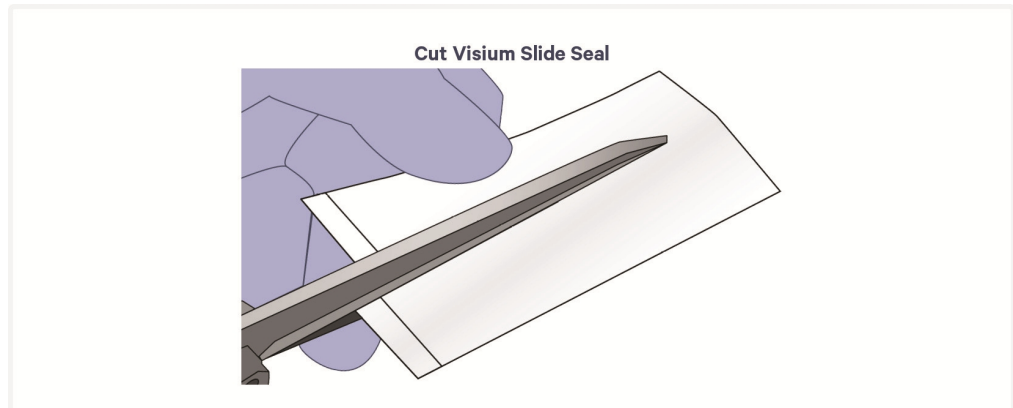

- Place the cassette flat on a clean work surface. Ensure surface of cassette is dry.
- Remove the back of the adhesive Visium Slide Seal.
- Align the Visium Slide Seal with the surface of the cassette and apply while firmly holding the cassette with one hand.
- Press on the Visium Slide Seal to ensure uniform adhesion.
- Use a fresh Visium Slide Seal when prompted during the protocol. Steps that do not require a new slide seal will specify that the slide seal should be pulled back and reapplied instead.

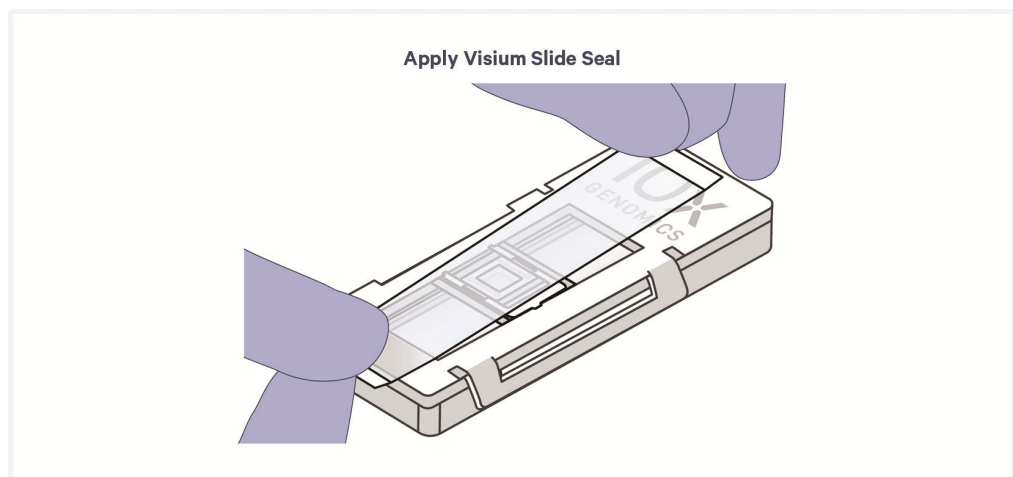

Removal

- Place the cassette flat on a clean work surface.
- Grasp a Visium Slide Seal corner. Carefully pull on the Visium Slide Seal up and across the cassette while firmly holding the cassette. Ensure that no liquid splashes out of the wells. Movement of the gasket during slide seal removal could damage the tissue section.

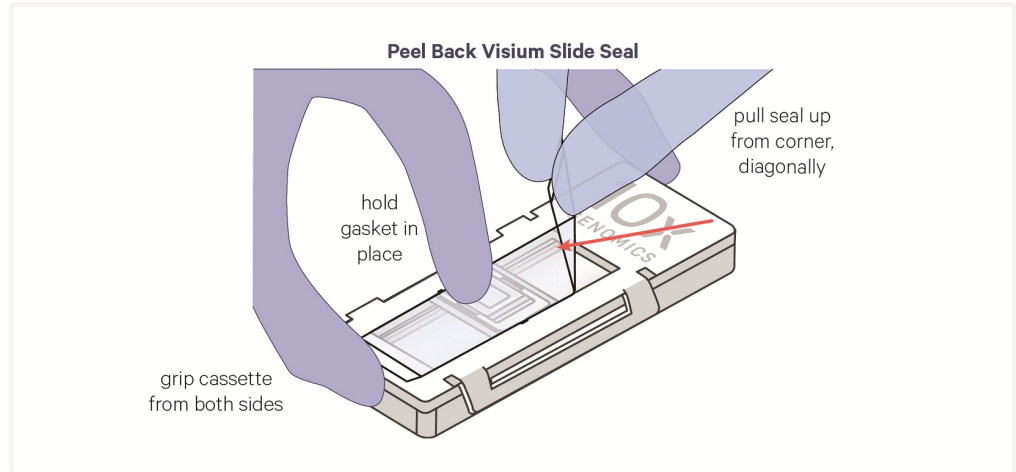

1. Tissue Handling, Freezing, Embedding, Sectioning, Section Placement, and Quality Assessment

Overview

This chapter provides guidance on tissue freezing, embedding, sectioning, section placement, and quality assessment. Proper tissue handling, storage, and preparation techniques preserve the morphological quality of tissue sections and the integrity of mRNA transcripts

Freshly obtained tissue samples must be snap frozen or directly embedded in a freezing and embedding compound, Optimal Cutting Temperature (OCT), to prevent RNA degradation and avoid ice crystal formation. Ice crystal formation may lead to morphological damage of the tissue. OCT helps preserve the structure of the tissue and provides structural support during cryosectioning. Other methods of freezing and embedding have not been validated.

When working with large tissues, segment the tissue at the time of tissue harvest into a smaller size that will fit into the OCT mold. Cut the tissue with a scalpel in a petri dish containing cold 1X PBS.

To assess RNA quality, RNA Integrity Value (RIN) scores may be calculated from the chosen fresh frozen sample. This measure of RNA quality relies on the assessment of the Bioanalyzer (or similar) electrophoretic trace. Tissue sections with $RIN \geq 4$ are optimal for the Visium HD assay. Low RIN scores do not necessarily result in poor data, but high scores are more likely to correlate with higher sensitivity.

While RIN values provide insights into RNA integrity, it is also important to consider the following key factors that help maintain RNA quality and tissue integrity

- Gentle handling of fresh tissue
- Minimizing post-mortem intervals
- Washing with RNase-free, cold isotonic storage conditions (such as cold 1X PBS) prior to freezing
- Immediate freezing of fresh samples
- Assessment of H&E image for signs of necrosis or other impacts to tissue integrity

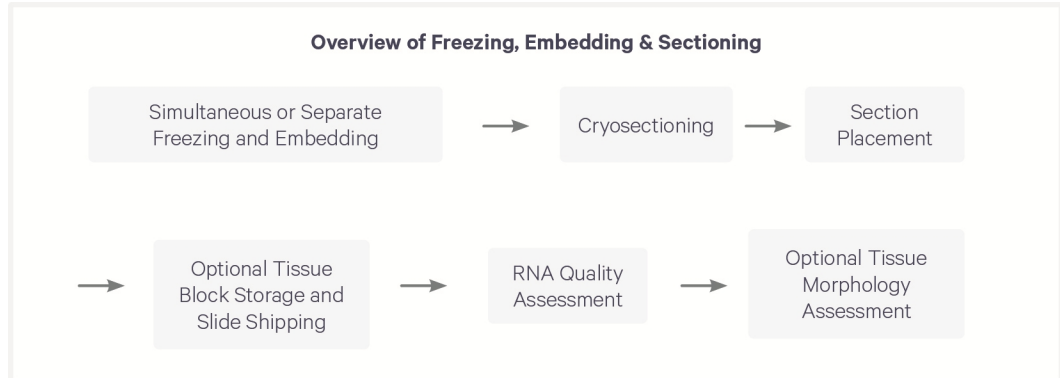

Tissue Handling

Prior to fixation and embedding, tissues should be handled according to the following guidelines to maximize RNA quality and prevent degradation.

Gentle Handling - Tissues should be handled gently to avoid mechanical stress. Mechanical stress may damage tissue structure. Examples of processes that introduce mechanical stress include ischemia, coagulative necrosis from electrocautery, and hemorrhages from surgical trauma. In the example image below, necrotic regions marked by green lines have signs of nuclear condensation (pyknosis) and nuclear fragmentation (karyorrhexis). These regions are typically characterized by poor RNA quality. The surrounding regions have normal-appearing nuclei.

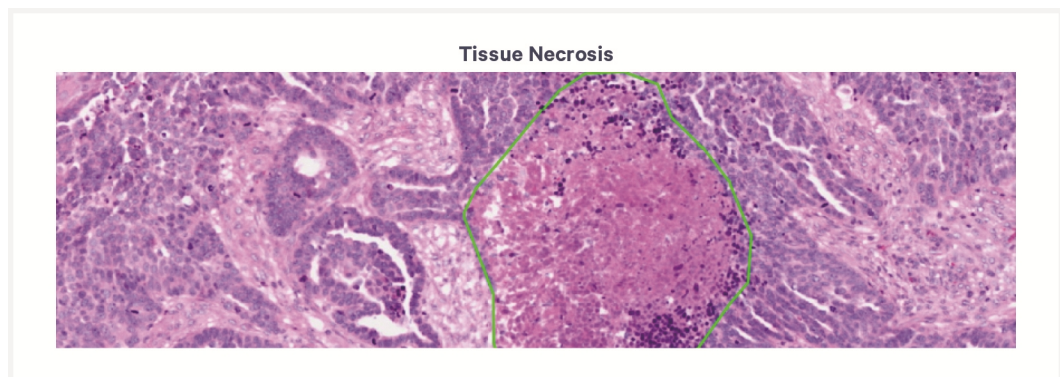

Minimizing Ischemia/Post Mortem Interval (PMI) - Prolonged ischemia and PMI can negatively affect tissue quality. If processing delays occur, keep tissues in a cold isotonic solution such as cold 1X PBS and avoid exceeding four hours between tissue resection and freezing. However, this allowable time may vary across tissues. For instance, some tissues have higher levels of RNases (lung, pancreas, etc.) and can be more prone to degradation. Long-term storage of fresh tissue in isotonic solutions is not recommended and tissue samples should be frozen immediately after resection. Delayed tissue freezing may lead to autolysis, degrading tissue, and negatively impacting results.

Frozen Tissue Block Preparation

Freshly obtained tissue can be frozen using two approaches. Both methods aim to preserve tissue morphology and minimize risk of artifacts.

Separate Freezing & Embedding

Tissue is frozen in an isopentane bath chilled with dry ice. This method may also be followed when tissues are already frozen by an external vendor (thus, only embedding in OCT is required).

Simultaneous Freezing & Embedding

Fresh tissue is embedded directly in pre-cooled OCT and frozen in an isopentane bath chilled with dry ice. This method is suitable when fresh tissue is available and ensures minimal handling. Ensure that the tissue is moisture-free to avoid ice crystal formation that can damage tissue morphology.

If dry ice is unavailable when setting up the isopentane bath, liquid nitrogen can be used as an alternative. However, isopentane chilled with dry ice is preferred over isopentane cooled with liquid nitrogen, as it provides more consistent and uniform freezing temperatures. Using isopentane with liquid nitrogen presents a risk of extremely cold temperatures that may potentially damage tissue morphology.



Never place tissue directly into liquid nitrogen to prevent surface boiling, air pockets, and freezing artifacts.

Prior to cryosectioning, ensure tissues are embedded in OCT. Unlike paraffin or resin-based embedding techniques, OCT does not interact with proteins and other molecules that impact antigenicity. OCT-embedding of the tissue offers the following advantages:

- Preserves the structure of the tissue and provides structural support during cryosectioning.
- Maintains an optimal temperature during sectioning, thus leading to smooth sections.
- Compatible with multiple staining procedures due to its water solubility.

Cryosectioning

OCT embedded tissue blocks are removed from the -80°C storage and cryosectioned in a cryostat to generate sections for RNA quality assessment & blank slides while keeping samples in a cold environment.

Section Placement

Tissue sections are placed within the allowable area on compatible blank slides. Placing only one section per slide is recommended.

RNA Quality Assessment

Assess RNA quality of the tissue block at this stage by calculating RNA Integrity Number (RIN) of freshly collected tissue sections. RNA quality assessment should be done before placing the tissue sections on blank slides. Use sections from the same tissue block that will produce sections for the main assay.

See RNA Quality Assessment for details. RIN should be ≥ 4 . Low RIN scores do not necessarily result in poor data, but high scores are more likely to correlate with higher sensitivity. Various factors could lead to low RIN scores, such as specific tissue types (diseased or necrotic tissues, ischemic tissue), suboptimal sample preparation and handling, suboptimal RNA extraction, or errors with the RNA QC platform.

RNA quality assessment requires 20–30 mg of tissue sections from OCT-embedded tissue block (~4 sections at $25\ \mu\text{m}$ thickness). If tissues contain extensive connective or adipose tissue, cryosection up to 50 mg of tissue. If extra sections are available, placing them on slides for Optional Tissue Morphology Assessment is recommended. Use the decision tree below to determine what quality assessment protocols should be followed.

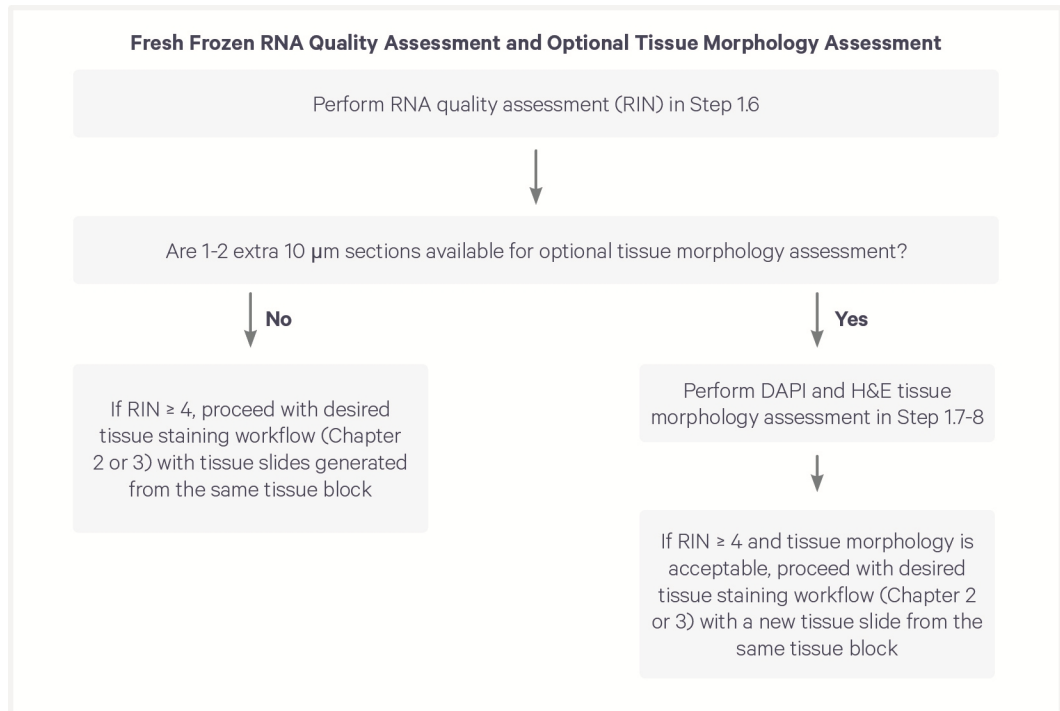

Optional Tissue Morphology Assessment

Assessment of tissue morphology prior to performing the Visium HD assay is recommended, but not mandatory. This assessment is composed of DAPI and H&E staining. After staining, tissues are assessed to determine suitability for the Visium HD assay.

DAPI and H&E may be performed on the same tissue section or on serial sections. If extra tissue sections are not available to perform this assessment, H&E or IF images generated later in this handbook may be evaluated to gain additional insights on sample quality.

Estimation of RIN scores as well as the morphological assessments based on H&E and/or DAPI help identify potential tissue morphology and RNA quality issues. However, these methods are not all-encompassing and may not always correlate exactly to final assay performance.

1.0 Preparation

Consult the Visium HD Spatial Applications Protocol Planner (CG000698) for a list of third-party items.

For Freezing & Embedding

Items	Preparation & Handling
Prepare	
<input type="checkbox"/> Isopentane in dry ice (preferred) OR liquid nitrogen	Fill two-thirds of a polypropylene beaker with isopentane sufficient to fully submerge the tissue (separate freezing & embedding) or cryomold (simultaneous freezing & embedding). Place in dry ice (same level as isopentane) to allow sufficient contact. Incubate 15 min.
	 <p>Isopentane Bath Setup</p>
	If dry ice is unavailable and the isopentane bath must be prepared with liquid nitrogen, fill two-thirds of a metal beaker with isopentane sufficient to fully submerge the tissue (separate freezing & embedding) or cryomold (simultaneous freezing & embedding). Place in a liquid nitrogen dewar (same level as isopentane). Incubate 15 min.
	Isopentane will slowly freeze if left too long in the liquid nitrogen bath. When this occurs, briefly remove the metal beaker containing isopentane from the liquid nitrogen bath. Once thawed, place the beaker back in the liquid nitrogen bath. DO NOT use the same isopentane bath for different tissue types.
<input type="checkbox"/> Tissue	If tissue is fresh, using a rolled up laboratory wipe, absorb excess blood or solution from the surface of the tissue to limit ice crystal formation. Tissue cracking may occur if tissue has been left in buffer for extended periods.
<input type="checkbox"/> Pre-cooled Cryovial or resealable bag	Pre-cool a WHEATON CryoELITE cryovial or resealable bag on dry ice.
<input type="checkbox"/> Pre-cooled OCT	Place OCT on ice for ≥30 min.
<input type="checkbox"/> Pre-cooled forceps	Place forceps on dry ice for ≥30 min.
Confirm	
<input type="checkbox"/> Cryomold	The cryomold used for embedding should be of appropriate size to fit the tissue sample.

For Cryosectioning

Items	Preparation & Handling	
Adjust		
<input type="checkbox"/>	Cryostat temperature settings	Turn cryostat on to pre-cool chamber. Recommended sectioning temperature is –20°C for cryostat blade and –10°C for the specimen head. Follow manufacturer's manual for detailed operations.
Equilibrate		
<input type="checkbox"/>	Blank slides to the cryostat chamber temperature	Slides should be cooled down to cryostat temperature for ≥30 min. Warm slides will lead to quick melting of the sections and degradation of RNA. If using a Nexterion Schott H slide, ensure the slide has been equilibrated to room temperature for 30 min after removing from storage before cooling down to cryostat temperature for ≥30 min.
<input type="checkbox"/>	OCT-embedded tissue block to cryostat chamber temperature	Freshly prepared or OCT-embedded tissue block stored at –80°C must be equilibrated to cryostat chamber temperature for at least 30 min before sectioning. If the tissue block is too cold, it will lead to section cracking. If the tissue block is too warm, it will lead to section compression or crumpling.

For Section Placement

Items	Preparation & Handling	
Confirm		
<input type="checkbox"/>	Section thickness setting	Recommended section thickness is 10 µm, but tissue section thicknesses of 10–20 µm have been validated with the assay.
<input type="checkbox"/>	Anti-roll plate is in place <i>Optional</i>	Anti-roll plate prevents rolling of tissue sections. Optimize the position of anti-roll plate based on the tissue block size. If possible, adjust the position of anti-roll plate before reaching area of interest.
		
<input type="checkbox"/>	Specimen head temperature	Confirm the temperature of the specimen head. If the sections appear cracked, the specimen head is too cold. If the sections appear crumpled, the specimen head is too warm. Adjust temperature accordingly.

Items	Preparation & Handling	
Confirm		
<input type="checkbox"/>	Slide storage	Pre-cool slide mailer or 50-ml centrifuge tube (one per tissue slide) to cryostat temperature for 10–15 min.

Items	Preparation & Handling
-------	------------------------

Practice

- Section placement on a blank slide. Create a representative allowable area on a blank slide. Optimize section quality and practice section placement within the allowable area before working with experimental blocks.

For RNA Quality Assessment

Items	Preparation & Handling
-------	------------------------

Equilibrate

- Microcentrifuge tube to cryostat chamber temperature. Microcentrifuge tube should be cooled down to cryostat temperature by placing the microcentrifuge tube in the cryostat chamber for ≥30 min or at -20°C for ≥30 min
- Forceps to the cryostat chamber temperature. Forceps should be cooled down to cryostat temperature by placing the forceps in the cryostat chamber for ≥30 min or at -20°C for ≥30 min

For Optional DAPI Staining

Prepare

- DAPI Solution. Prepare DAPI Solution on ice, adding reagents in the order listed. Pipette mix 10x and centrifuge briefly. Maintain on ice. 500 µl of DAPI solution is sufficient for one slide.

DAPI Solution	Stock	Final	Total Amount (µl)
1X PBS	-	-	497.5
DAPI	100X	0.5X	2.5
Total	-	-	500.0

1.1 Separate Tissue Freezing & Embedding

- a. Using either forceps or a spatula, lower tissue into isopentane until fully submerged. Submerge tissue for ~1 min or until frozen. Freezing time may vary based upon tissue type and size.
- b. Once frozen, transfer tissue to pre-cooled WHEATON CryoELITE cryovial or resealable bag on dry ice.



To prevent evaporation and dehydration, the snap-frozen tissue block must be stored in a sealed container.



- c. Transport cryovial on dry ice and store frozen tissue at **-80°C** for **long-term** storage or immediately proceed to the next step.
- d. Label an appropriately sized cryomold to mark the orientation of the tissue and place at room temperature.



Label the cryomold before adding OCT and tissue. OCT will quickly turn white once frozen, making it hard to determine tissue orientation later.

- e. If frozen tissue was stored, remove cryovial containing frozen tissue from **-80°C** and transfer in dry ice.
- f. Fill cryomold with pre-cooled OCT without introducing bubbles.
- g. Using pre-cooled forceps, place frozen tissue into the OCT, covering any exposed surfaces with additional OCT. Confirm there are no bubbles, especially near tissue.
- h. Immediately lower cryomold containing tissue into isopentane.
- i. Wait until OCT is completely frozen.

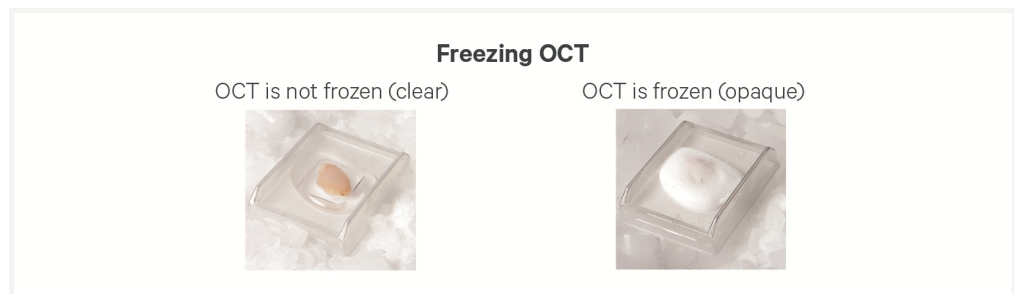

- j. Store OCT embedded tissue block in a sealed container at **-80°C** for **long-term** storage or immediately proceed to [1.3 Cryosectioning on page 28](#).



A WHEATON CryoELITE cryovial or a resealable bag should be used for storing the tissue block. Failure to use a sealed container for storage may dehydrate and damage the tissue.

If using a cryovial, apply a thin layer of OCT to the tissue to form a protective layer. Allow OCT to freeze. Score the OCT to mark tissue orientation, as this will be lost when tissue block is removed from cryomold. Remove tissue block from cryomold. If needed, trim using a razor blade to fit into the cryovial.

1.2 Simultaneous Tissue Freezing & Embedding

- a. Label an appropriately sized cryomold to mark the orientation of the tissue and place at room temperature.



Label the cryomold before adding OCT and tissue. OCT will quickly turn white once frozen, making it hard to determine tissue orientation later.

- b. Fill cryomold with pre-cooled OCT without introducing bubbles.
- c. Using pre-cooled forceps, place tissue into the OCT, covering any exposed surfaces with additional OCT. Confirm there are no bubbles, especially near tissue.
- d. Immediately lower cryomold containing tissue into isopentane.
- e. Wait until OCT is completely frozen.

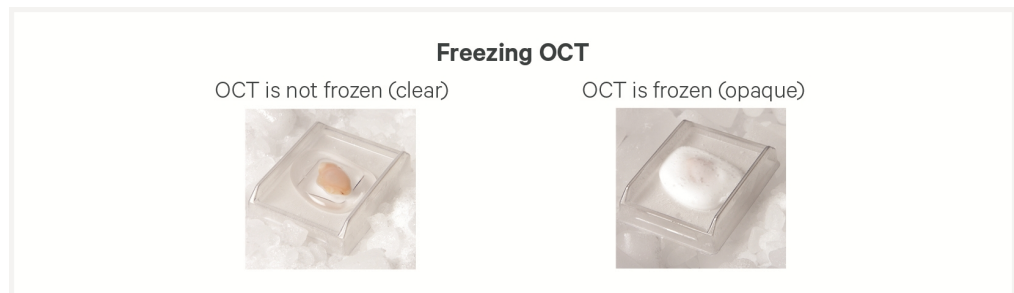

- f. Store OCT embedded tissue block in a sealed container at **-80°C** for **long-term** storage or immediately proceed to [1.3 Cryosectioning on the next page](#).



A WHEATON CryoELITE cryovial or a resealable bag should be used for storing the tissue block. Failure to use a sealed container for storage may dehydrate and damage the tissue.

If using a cryovial, apply a thin layer of OCT to the tissue to form a protective layer. Allow OCT to freeze. Score the OCT to mark tissue orientation, as this will be lost when tissue block is removed from cryomold. Remove tissue block from cryomold. If needed, trim using a razor blade to fit into the cryovial.

1.3 Cryosectioning

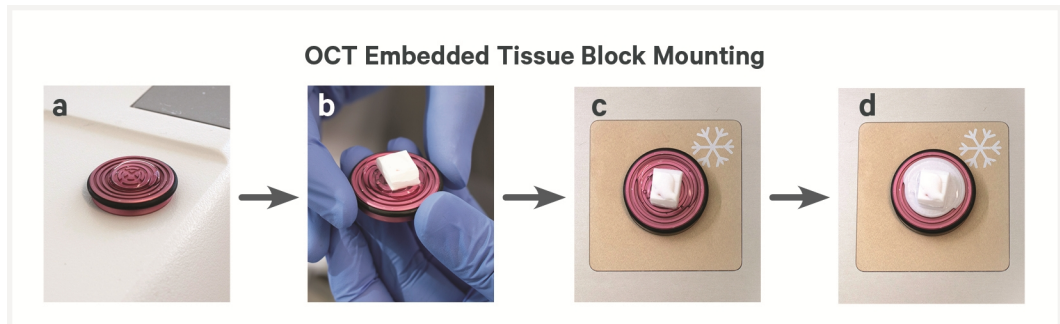

- a.** Fill specimen stage (chuck) with OCT.



Ensure OCT-embedded tissue block has been equilibrated to cryostat temperature as described in [1.0 Preparation on page 23](#)

- b.** Place OCT-embedded tissue block on stage with cutting surface facing away from stage.
- c.** Place stage and tissue block on cryobar inside cryostat chamber.
- d.** Allow OCT and tissue block to freeze and adhere to specimen stage.
- e.** Once frozen, install stage with tissue block on specimen head of cryostat and start sectioning to remove excess OCT.

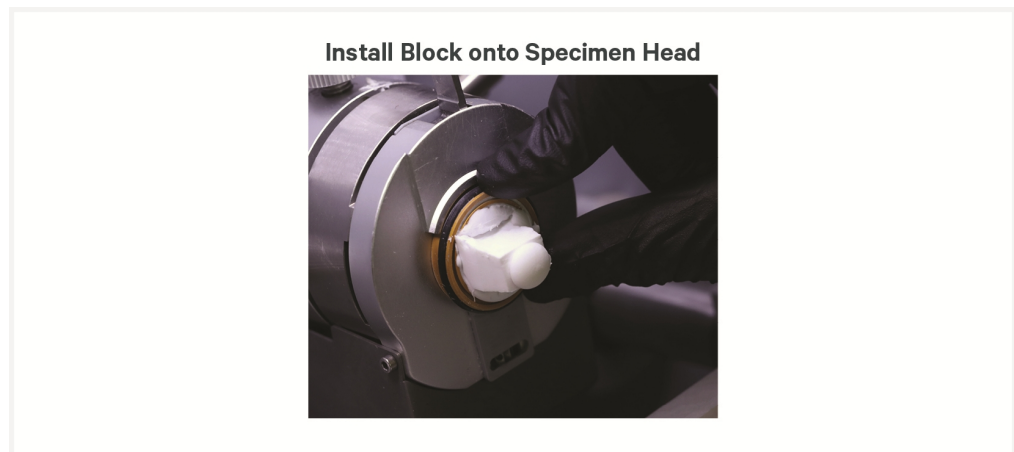

Sectioning conditions vary across different tissues and cryostats. Follow manufacturer's recommendation for cryosectioning.

- f.** Continue sectioning until tissue is visible. Once tissue is visible, subsequent sections may be used for section placement. See [Section Thickness on page 9](#) for information on recommended thickness.

- g. Acquiring sections from the tissue block for RNA quality assessment is recommended. This should be done prior to placement of tissue onto blank slides. See [1.6 RNA Quality Assessment on page 31](#) for more information.

1.4 Section Placement

- a. Once desired tissue section is obtained, carefully flatten it out by gently touching the surrounding OCT with cryostat brushes.
- b. Gently touch section to front of pre-chilled blank slide within allowable area.



DO NOT place sections on a room temperature slide. Slide should be equilibrated to cryostat chamber.

- c. Immediately place a finger on backside of the slide for a few seconds to allow section to adhere.

Ensure that entire tissue section is fully adhered.



DO NOT remove slide from cryostat chamber at any point during sectioning and tissue placement.

- d. Immediately place tissue slide with the tissue facing up on cryobar to freeze the section. Continue transferring sections on remaining slides.

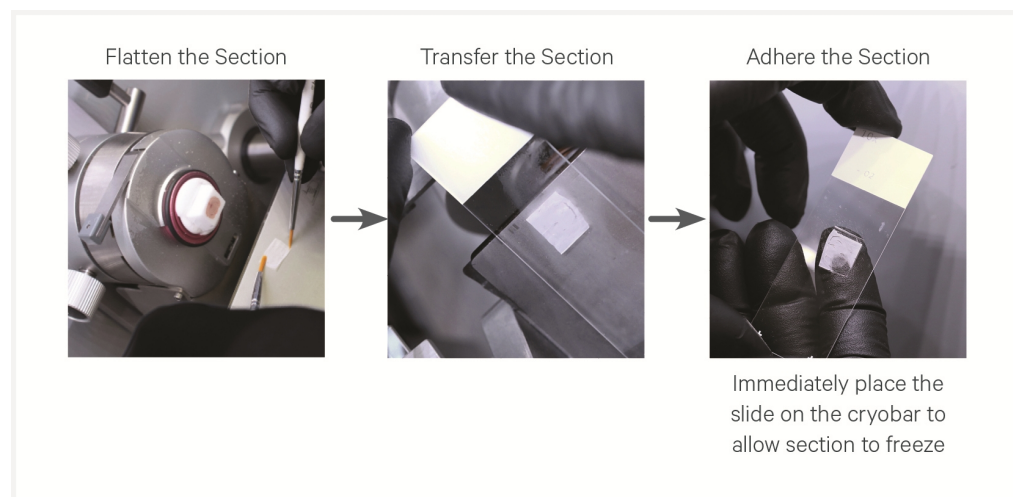

- e. Transfer slides containing tissue sections to a pre-cooled slide mailer. Alternatively, use a pre-cooled 50-ml centrifuge tube.

Store slides individually (one slide per 50-ml centrifuge tube, if using) in a sealed container. If using an unsealed slide mailer, store in a secondary sealed container, such as a resealable bag.

- f. Transfer slides within slide mailer or centrifuge tube to dry ice.



- g. Store slides at -80°C for up to **2 months** or immediately proceed to either optional morphology assessment or tissue staining.

1.5 Tissue Block Storage and Tissue Slide Shipping

Leftover Tissue Block Storage

- Remove leftover tissue block attached to the specimen stage from the cryostat's specimen head and place onto cryobar.
- Cover exposed tissue with a thin layer of pre-cooled OCT and allow to freeze.
- Frozen tissue block can be stored attached to specimen stage in a sealed container at -80°C . To separate frozen tissue block from specimen stage, lift tissue block and stage from cryobar and lightly warm stage with hands or an aluminum block at room temperature.
- DO NOT let block and tissue fully melt, as this will severely damage the tissue. Separation of the tissue block from the specimen stage is optional.
- Immediately place tissue block in dry ice. Ensure that melted areas have refrozen.
- Store in a sealed container at -80°C for **long-term** storage.

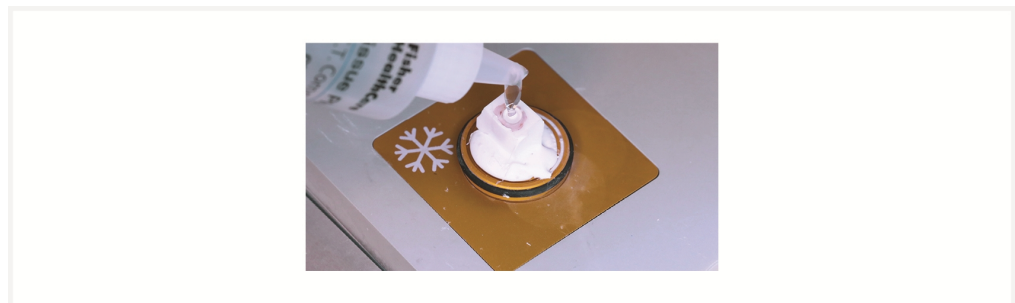

Slide Shipping

- Place tissue slides in a slide mailer and keep cold. If shipping multiple slides, ensure that there is sufficient space in between slides to avoid contact. If placing a slide in the last slot, ensure slide does not face outward. This guidance also applies to storing slides in a 50-ml centrifuge tube.
- Place mailer in a tightly sealed secondary container to limit exposure and keep cold.
- Samples can be shipped overnight in dry ice, provided there is enough dry ice to account for transit and delivery times.

- See local institution or delivery service for detailed instructions on shipping samples in dry ice.

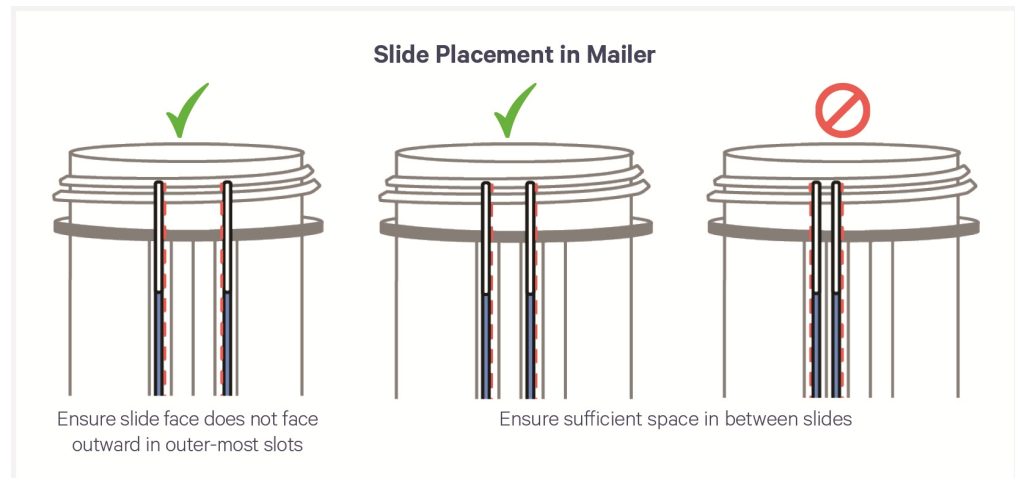

1.6 RNA Quality Assessment

RNA quality assessment is recommended. If RNA will not be assessed, proceed directly to appropriate staining section within this workbook.



- Cryosection **20–30 mg** of tissue sections from OCT-embedded tissue block (~4 sections at 25 μ m thickness). If tissues contain extensive connective or adipose tissue, cryosection up to **50 mg** of tissue.
- If OCT is excessive (\geq 1 mm surrounding the tissue), remove excess OCT with a razor blade or with cooled forceps.
Excess OCT may reduce RNA quality score.
- Using cooled forceps, transfer sections to a pre-cooled microcentrifuge tube.
- Place pre-cooled microcentrifuge tube containing sections on dry ice. Store at -80°C or proceed to RNA extraction.



DO NOT allow samples to melt, as this will lead to degradation of RNA and a poor RIN score.

- e. Proceed with RNA extraction following manufacturer's instructions (See Visium HD Protocol Planner, CG000698, for tested part numbers). After RNA isolation, place sample on ice.
- f. Store purified RNA at **-80°C** for **long-term** storage or immediately proceed to RIN calculation using either Bioanalyzer or TapeStation reagents. Follow manufacturer's instructions for RIN calculation.



Ensure RNA is quantified using a Qubit or Nanodrop and loaded within specifications of the relevant assay kit before running RNA on TapeStation or Bioanalyzer.

RIN Trace Examples

This section contains example traces for RNA Integrity Number (RIN) assessment. This protocol was optimized using samples with RIN ≥ 4 .

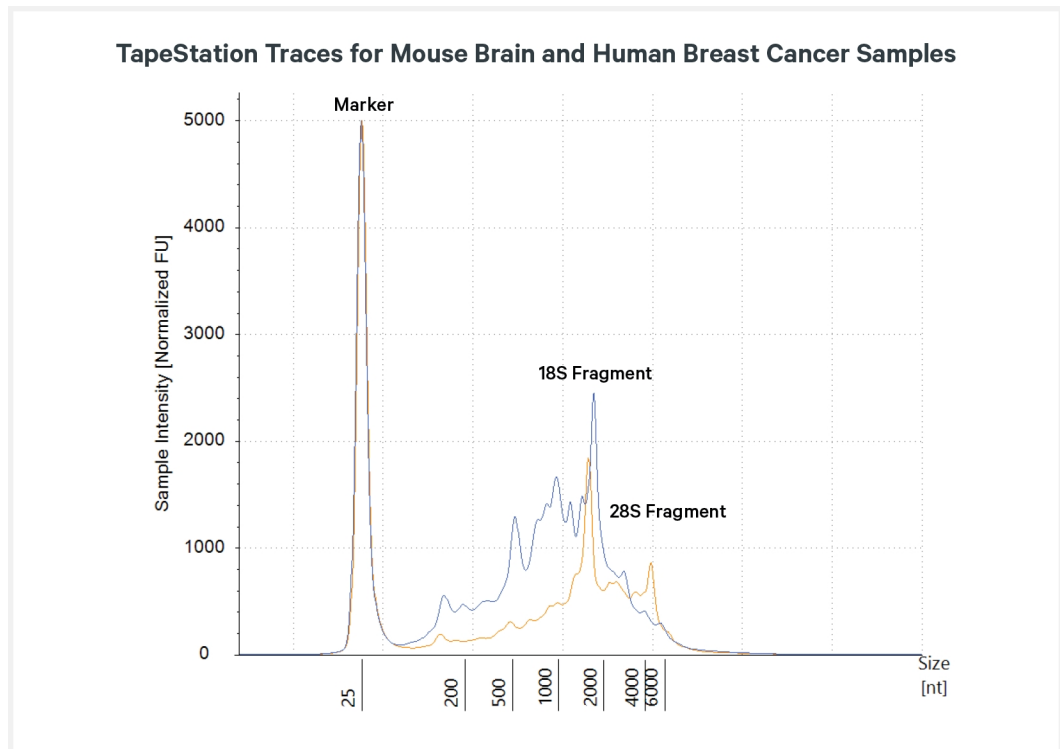

Samples displayed above are from intact (mouse brain, yellow, RIN = 7;) and degraded (human breast cancer, blue, RIN = 4.4) RNA. The CELLDATA RNASTORM Fresh Cell and Tissue RNA Isolation Kit was used for RNA isolation. The TapeStation High Sensitivity RNA Screentape kits were used for RIN calculation.

1.7 Optional DAPI Staining for Tissue Morphology Assessment

If extra tissue slides are available, optional tissue morphology assessment via DAPI and H&E staining is recommended.

Prior to DAPI and H&E staining, tissue slide preparation and fixation is required. Prepare slide as described in [2.2 Tissue Slide Preparation on page 44](#) and fix as described in [2.3 Fixation on page 45](#).

DAPI Staining

- a. Place tissue slide on a flat, clean, nonabsorbent work surface.
- b. Add **500 µl** DAPI solution per slide to uniformly cover all tissue sections.
- c. Incubate **1 min** in the dark at **room temperature**.
- d. Discard reagent by holding slides at an angle with the bottom edge in contact with a laboratory wipe
- e. Add **1 ml** 1X PBS per slide to uniformly cover all tissue sections.
- f. Incubate **1 min** in the dark at **room temperature**.
- g. Discard reagent by holding slides at an angle with the bottom edge in contact with a laboratory wipe
- h. Repeat steps e-g twice more for a total of three washes.
- i. If the same tissue section will be used for H&E morphology assessment, mount coverslip as described in [3.7 Coverslip Mounting on page 78](#) and image as described in [3.8 Imaging on page 79](#). If a serial section will be used for the optional H&E morphology assessment, mounting a coverslip is not necessary.

Quality Assessment

Review the DAPI image under the microscope at 20x magnification. Examine several sections within a single DAPI-stained section to ensure assessment is comprehensive. Tissue sections optimal for the assay should have:

- Punctate nuclei that are clearly defined
- DAPI staining that does not appear washed out

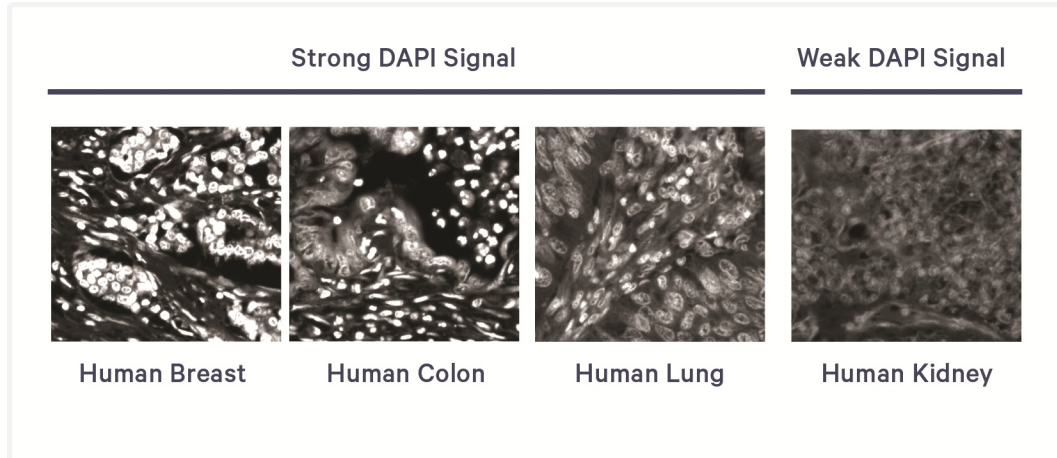

Sections with poor DAPI staining are unlikely to generate good data. All samples in the images below were imaged under the same conditions (405 nm channel). After evaluating DAPI staining, remove coverslip as described in [2.7 Coverslip Removal on page 49](#) and proceed to [1.8 Optional H&E Staining for Tissue Morphology Assessment](#) below.

1.8 Optional H&E Staining for Tissue Morphology Assessment

Prior to H&E staining, tissue slide preparation and fixation is required. Prepare slide as described in [2.2 Tissue Slide Preparation on page 44](#) and fix as described in [2.3 Fixation on page 45](#).

H&E Staining

Perform H&E staining as described in [2.4 H&E Staining on page 46](#), coverslip as described in [2.5 Coverslip Mounting on page 48](#) and image as described in [2.6 Imaging on page 49](#).

Quality Assessment

Ensure that the tissue section is free from tissue processing and sectioning artifacts as shown in the images below and in [Troubleshooting on page 81](#). Tissue processing artifacts may include improper snap freezing, squeeze/crush artifacts, ice crystal artifacts, and hemorrhaging. If imaging reveals satisfactory tissue morphology, proceed with the appropriate staining protocol using a different tissue slide.

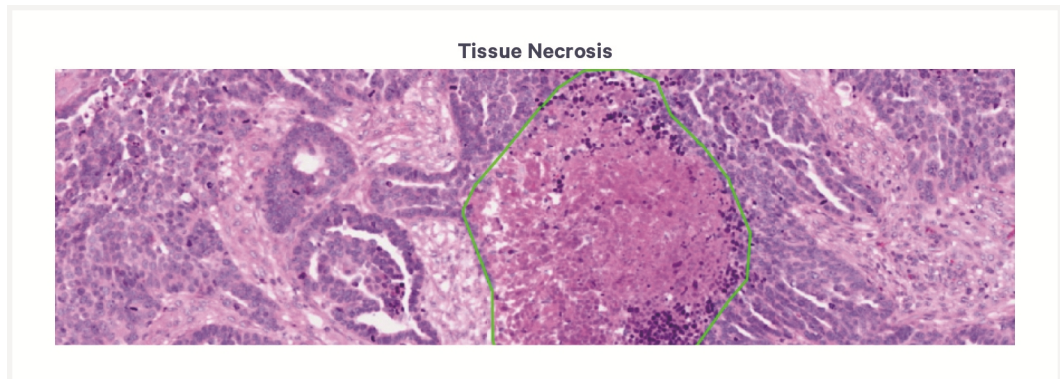
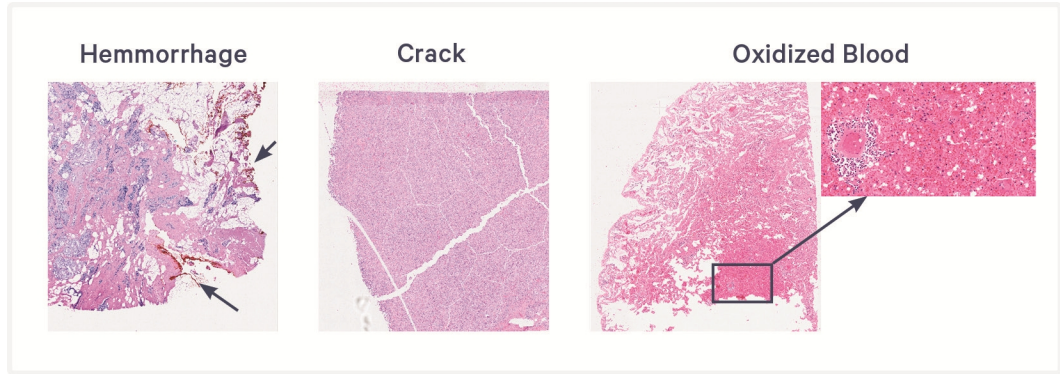

Staining protocols:

- [2. H&E Staining & Imaging on page 36](#)
- [3. IF Staining & Imaging on page 54](#)

2. H&E Staining & Imaging

2.0 Overview

This chapter provides guidance on the fixation, H&E staining, imaging, destaining, and permeabilization of fresh frozen tissue slides. Process up to two tissue slides at a time. Ensure that microscope settings have been verified and imaging programs have been created prior to starting this protocol. Consult the Visium HD Spatial Applications Imaging Guidelines Technical Note (CG000688) for more information.

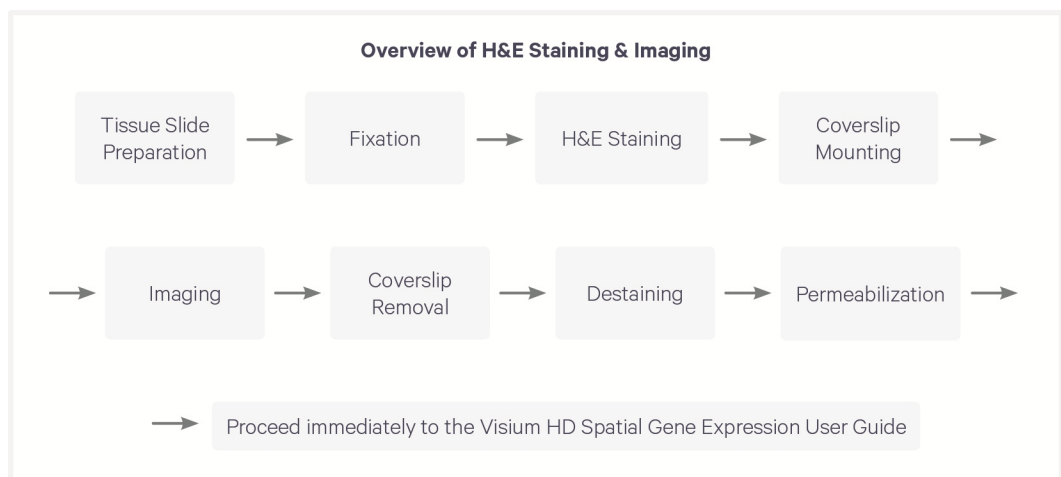

2.1 Preparation

Consult the Visium HD Spatial Gene Expression Protocol Planner (CG000698) for a list of third-party items. If using slide containers other than slide mailers (where applicable), such as 15 or 50-ml centrifuge tubes, reagent volumes will need to be scaled appropriately so that tissue sections are completely covered by reagent. If using a centrifuge tube, ensure that the two tissue slides have their tissue sections facing away from one another.

 During this chapter, the tissue slide cassette will be reused. Save the original tissue slide cassette bag for storage.

The preparation steps described in this section are for processing two tissue slides.

 Washing tissue sections with RVC and adding RNase Inhibitor to mounting media is optional if tissue sections will be imaged, destained, and hybridized with probes on the same day. These RNA-protecting reagents are required for all supported stopping points in this document.

Ensure that all solutions are prepared prior to removing tissue slides from **-80°C**.

For Fixation & Permeabilization

Items	Preparation & Handling
Obtain	
<input type="checkbox"/> Nuclease-free Water	-
<input type="checkbox"/> PBS	Either 1X PBS or 10X PBS may be used. If using 10X PBS stock, PBS must be diluted to 1X according to the 1X PBS dilution table below.
<input type="checkbox"/> Formaldehyde or Paraformaldehyde	-
<input type="checkbox"/> 10% SDS	-
<input type="checkbox"/> Methanol	-
<input type="checkbox"/> Slide Mailers	-
<input type="checkbox"/> Forceps	-
<input type="checkbox"/> Bucket of Ice	-
<input type="checkbox"/> Bucket of Dry Ice	-
Prepare all reagents fresh before retrieving slides from storage	
<input type="checkbox"/> 1X PBS	If using 10X PBS stock, dilute according to the table below. Add reagents in the order listed. Invert gently to mix. Maintain at room temperature.

1X PBS	Stock	Final	Total Amount (ml)
Nuclease-free water	-	-	90.0
PBS	10X	1X	10.0
Total	-	-	100.0

Fixation Solution

Using 1X PBS prepared above, prepare Fixation Solution using either Formaldehyde or Paraformaldehyde according to the appropriate table below. Formaldehyde and Paraformaldehyde should be handled in a biosafety hood due to their hazardous nature. Add reagents in the order listed. Invert gently to mix. Maintain at room temperature. DO NOT immerse more than two slides in a single slide mailer.

Fixation Solution (using formaldehyde)	Stock	Final	Total Amount (ml)
1X PBS	-	-	9.0
Formaldehyde	37%	3.7%	1.0
Total	-	-	10.0

Fixation Solution (using paraformaldehyde)	Stock	Final	Total Amount (ml)
1X PBS	-	-	7.5
Paraformaldehyde	16%	4%	2.5
Total	-	-	10.0

1% SDS

Prepare 1% Sodium dodecyl sulfate (SDS). Add reagents in the order listed. Invert gently to mix. Maintain at room temperature. Verify no precipitate in SDS before use.

1% SDS	Stock	Final	Total Amount (ml)
Nuclease-free water	-	-	9.0
SDS	10%	1%	1.0
Total	-	-	10.0

70% Methanol

Prepare 70% Methanol. Add reagents in the order listed. Invert gently to mix. Maintain at room temperature until pre-chill (see "Prepare slide Mailers" below)

70% Methanol	Stock	Final	Total Amount (ml)
Methanol	100%	70%	7.0
Nuclease-Free Water	-	-	3.0
Total	-	-	10.0

Items	Preparation & Handling
Prepare Slide Mailers. Process no more than two slides per mailer.	
<input type="checkbox"/> Fixation Solution	Label one slide mailer as Fixation Solution Mailer. Dispense 10 ml Fixation Solution. Pre-chill Fixation Solution at -20°C for 30 min.
<input type="checkbox"/> 1X PBS	Label six slide mailers as 1X PBS Mailer 1-6. Dispense 10 ml 1X PBS into each slide mailer.
<input type="checkbox"/> 1% SDS	Label one slide mailer as 1% SDS Mailer. Dispense 10 ml 1% SDS solution.
<input type="checkbox"/> 70% Methanol	Label one slide mailer as 70% Methanol Mailer. Dispense 10 ml 70% Methanol. Pre-chill 70% Methanol on ice for 30 min.

For H&E Staining

Items	Preparation & Handling
<input type="checkbox"/> Milli-Q or UltraPure Water	Label six 1000-ml beakers as Water Beakers 1–6. Dispense 800 ml of water into each beaker. Dispensed volumes in each beaker can be used for two slides. Alternatively, use 50-ml centrifuge tubes instead of beakers (one tissue slide per 50-ml centrifuge tube).
<input type="checkbox"/> Alcoholic Eosin	Prepare 30 ml in a 50-ml conical tube for each tissue slide.
<input type="checkbox"/> Gill II Hematoxylin	
<input type="checkbox"/> Bluing Buffer	

Optional Staining Reagents - Only Required if Using Stopping Point

Items	Preparation & Handling
<input type="checkbox"/> Ribonucleoside Vanadyl Complex (RVC)	Preparing aliquots: Incubate sealed vial at 65°C in a heating block, bead bath, or water bath for 20 min or until solution is reconstituted to a dark green solution with no visible particulates. Aliquot into single-use tubes (30 µl per slide). Store tubes at -20°C. DO NOT exceed 2 freeze-thaw cycles per aliquot. If using an aliquot immediately, no freezing is necessary. Store at room temperature until use. Gently invert every 10 min.

Using a frozen aliquot: remove aliquot from -20°C and incubate at 65°C for 10 min to remove precipitate.

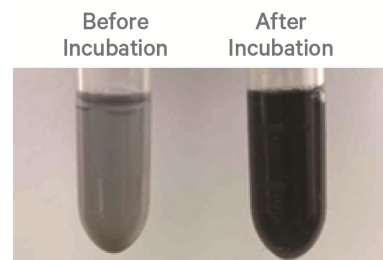

<input type="checkbox"/> RVC Working Solution	Prepare Ribonucleoside Vanadyl Complex stock as described above prior to generating working solution. Pipette mix. Maintain at room temperature.
---	--

RVC Working Solution <i>1 slide = 1 Tissue Slide</i>	Stock	Final	1 Slide (µl)	2 Slides +15% (µl)
Nuclease-free Water	-	-	497.5	1,144.2
Ribonucleoside Vanadyl Complex	200 mM	1 mM	2.5	5.8
Total	-	-	500.0	1,150.0

For Imaging

Items	Preparation & Handling				
Prepare - Select One Mounting Medium					
<input type="checkbox"/> Mounting Medium	Prepare this Mounting Medium if stopping point will not be used. Invert to mix. Briefly centrifuge to remove bubbles. Inspect for bubbles. Continue centrifuging until no bubbles remain. Maintain at room temperature.				
	Mounting Medium 1 slide = 1 Tissue Slide	Stock	Final	1 Slide (µl)	2 Slides +15% (µl)
	Glycerol	100%	85%	127.5	293.3
	Nuclease-free Water	-	-	22.5	51.7
	Total	-	-	150.0	345.0
<input type="checkbox"/> Stopping Point Mounting Medium	Prepare this Mounting Medium if stopping point will be used. Invert to mix. Briefly centrifuge to remove bubbles. Inspect for bubbles. Continue centrifuging until no bubbles remain. Maintain at room temperature.				
	Stopping Point Mounting Medium 1 slide = 1 Tissue Slide	Stock	Final	1 Slide (µl)	2 Slides +15% (µl)
	Glycerol	100%	85%	127.5	293.3
	Nuclease-free Water	-	-	15.0	34.5
	RNase Inhibitor	40U/µl	2U/µl	7.5	17.3
	Total	-	-	150.0	345.0
Obtain					
<input type="checkbox"/> Coverslip	-				

For Destaining

Items	10x PN	Preparation & Handling	Storage
Obtain			
<input type="checkbox"/> 0.N HCl	-	If necessary, prepare 0.1 N HCl using nuclease-free water.	Ambient

Protocol Overview

Slide Preparation & Fixation ~35 min

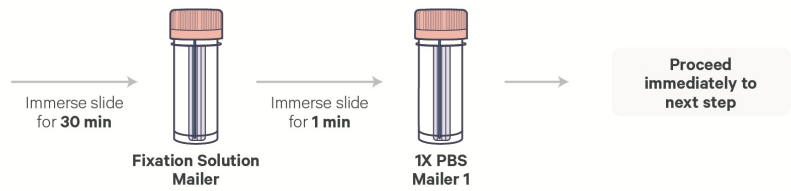
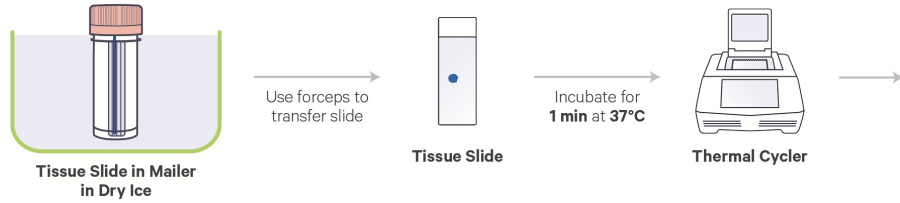

H&E Staining & Imaging

H&E Staining & Coverslipping ~15 min

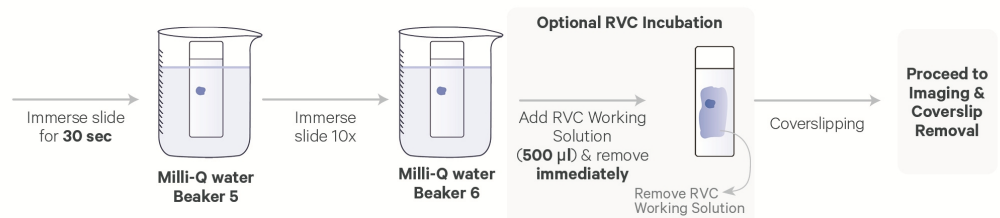
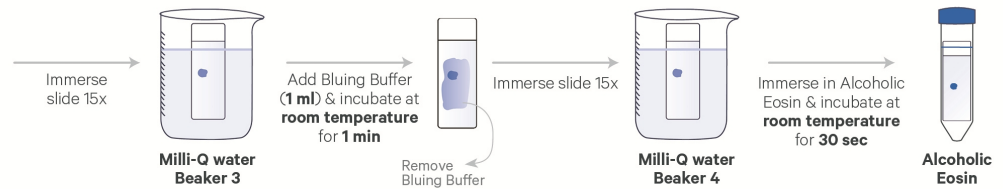
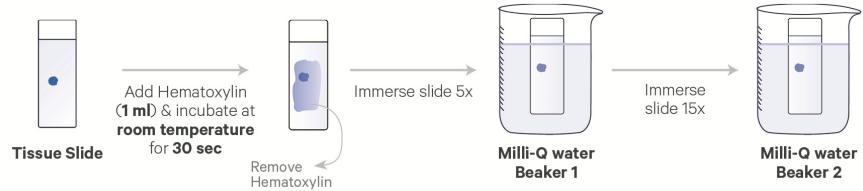

Wipe excess liquid from the back of the slide after each immersion series

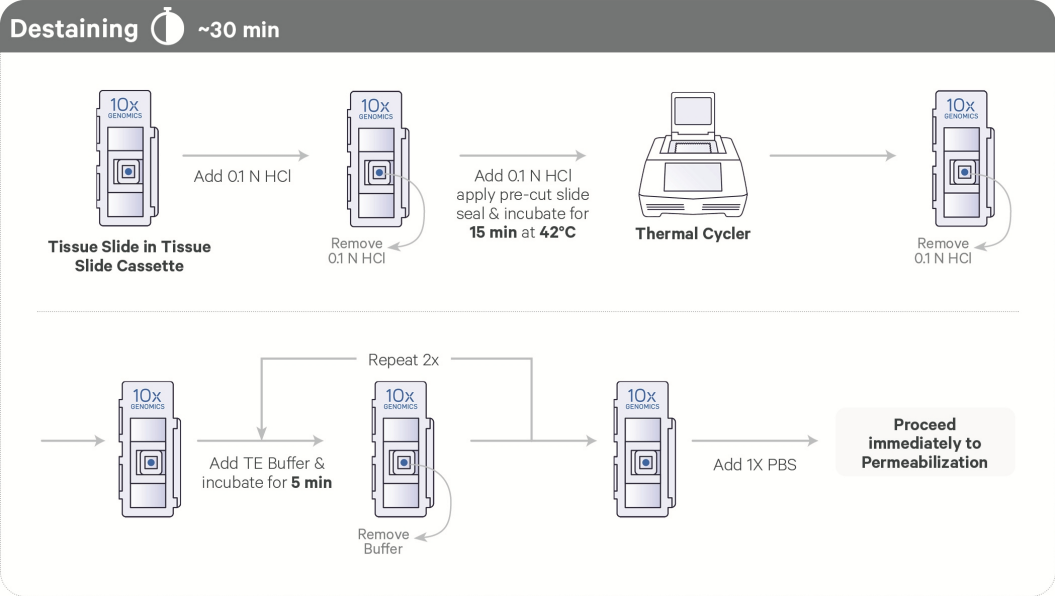

H&E Staining & Imaging

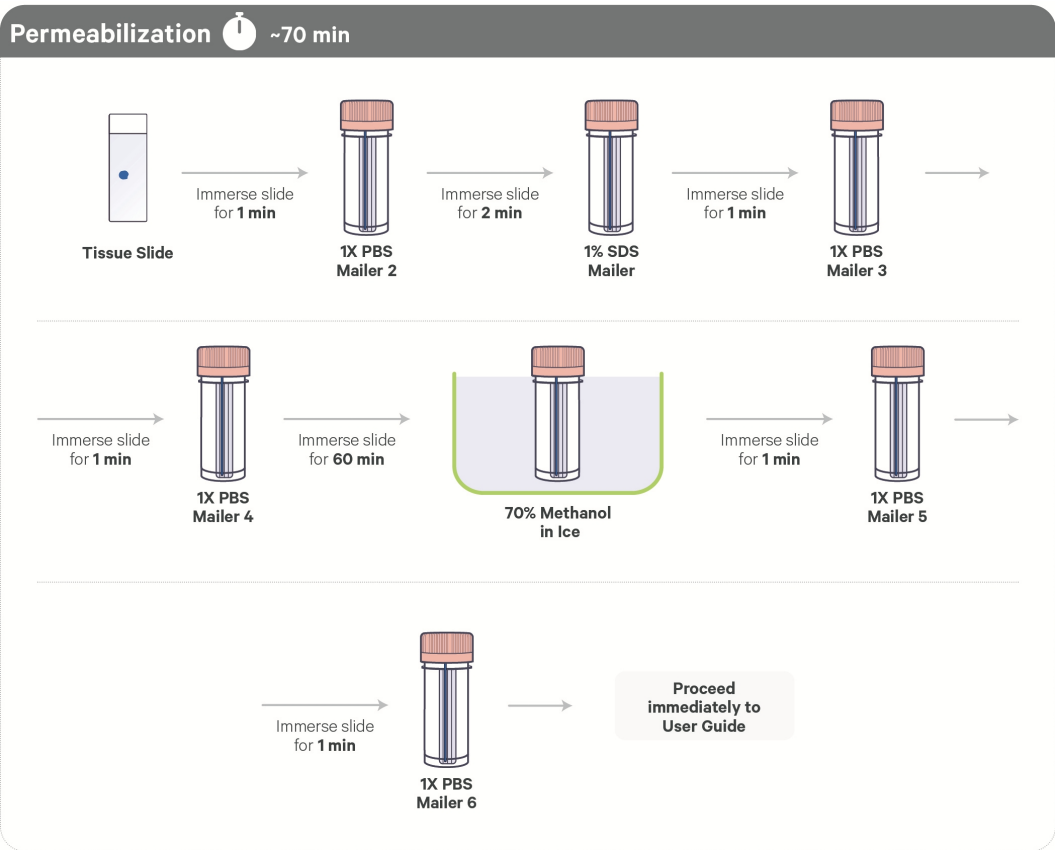

2.2 Tissue Slide Preparation

- a. Place Low Profile Thermocycler Adapter in thermal cycler set to incubate at **37°C**. DO NOT close lid.

Prepare the Fixation Solution Mailer and a timer set to 1 min, which are needed in the following steps.

- b. Prepare a bucket of dry ice.
- c. Remove slide mailer containing stored fresh frozen tissue slides from **-80°C** and bury into the dry ice.

*Alternatively, submerge an uncapped empty slide mailer in dry ice and incubate for **5 min**. Remove slides from **-80°C** storage with forceps and immediately place in pre-chilled empty slide mailer on dry ice.*

- d. Using forceps, move slides from dry ice to the **37°C** pre-heated thermal cycler for **1 min**. Place slides on Thermocycler Adapter with tissue side facing up. Ensure Sample Area is aligned with the corresponding area on the Thermocycler Adapter. DO NOT close lid.

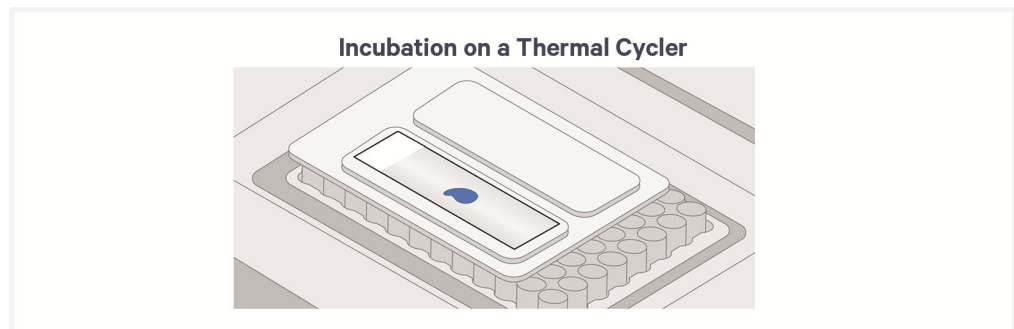

2.3 Fixation

- a. **Immediately** remove slide from thermal cycler following incubation. Gently immerse slide in Fixation Solution Mailer using slide forceps and incubate for **30 min** at **room temperature**. Follow slide placement mailer guidance in the illustration below for all steps where a slide is placed in a slide mailer.



DO NOT immerse more than two slides in a single slide mailer. Formaldehyde and Paraformaldehyde should be handled in a biosafety hood due to their hazardous nature. Transfer slides immediately to Fixation Solution after removal from thermal cycler to prevent freezing artifacts.



Ensure 70% Methanol Mailer is pre-chilled on ice, with ice completely covering the tube below the cap, before proceeding to next step. See [Tips & Best Practices](#) for guidance on immersing slides into mailers.

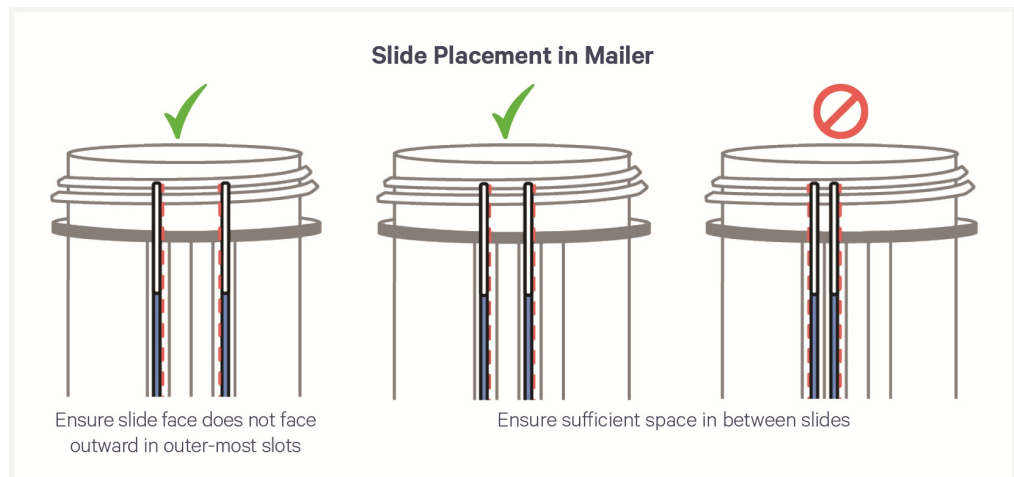

- b. Remove slide from fixative and gently immerse slide in 1X PBS Mailer 1 and incubate for **1 min** at **room temperature**.

After 1X PBS incubation, remove any marker annotations using a lint-free laboratory wipe and 100% Ethanol.

2.4 H&E Staining

- a. Place slide on a flat, clean, nonabsorbent work surface. Some residual droplets may remain.
- b. Add **1 ml** Hematoxylin per slide to uniformly cover all tissue sections.



If staining two tissue slides at a time, ensure that hematoxylin is discarded quickly after incubation to prevent overstaining.

- c. Incubate **30 sec** at **room temperature**.



- d. Discard reagent by holding slides at an angle with the bottom edge in contact with a lint-free laboratory wipe.
- e. Immerse slides 5x in Water Beaker 1.
- f. Immerse slides 15x in Water Beaker 2.
- g. Immerse slides 15x in Water Beaker 3.
- h. Wipe excess liquid from back of slides without touching the tissue section.
- i. Place slide on a flat, clean, nonabsorbent work surface. Some droplets may remain.
- j. Add **1 ml** Bluing Buffer per slide to uniformly cover all tissue sections.
- k. Incubate **1 min** at **room temperature**.
- l. Discard reagent by holding slides at an angle with the bottom edge in contact with a lint-free laboratory wipe.

- m.** Immerse slides 15x in Water Beaker 4.
- n.** Wipe excess liquid from back of slides with a lint-free laboratory wipe without touching the tissue section. Place on a flat, clean, nonabsorbent work surface. Some droplets may remain.
- o.** Gently immerse slides in alcoholic Eosin solution in separate 50 ml conical tubes.
- p.** Incubate **30 sec** at **room temperature**. DO NOT use diluted Eosin.
- q.** Discard reagent by holding slides at an angle with the bottom edge in contact with a lint-free laboratory wipe.
- r.** Immerse slides for **30 sec** in Water Beaker 5.
- s.** Immerse slides 10x in Water Beaker 6.
- t.** Wipe excess liquid from back of slides with a lint-free laboratory wipe without touching the tissue section. Place on a flat, clean, nonabsorbent work surface.
- u.** *Optional RNA protection - only if using pre or post-imaging stopping point*
 - Add **500 µl** RVC Working Solution per slide to uniformly cover all tissue sections.
 - Immediately discard reagent by holding slides at an angle with the bottom edge in contact with a lint-free laboratory wipe and gently tapping the slide against the wipe.

Ensure RVC Working Solution is completely removed before proceeding. Failure to remove RVC Working Solution may lead to weaker eosin staining. DO NOT allow slides to air dry.
- v.** Proceed to [2.5 Coverslip Mounting on the next page](#).

2.5 Coverslip Mounting

- a. Place slides on a flat, clean, nonabsorbent work surface. Some residual droplets may remain.
- b. Using a **wide-bore** pipette tip:
 - If **not** using stopping point, add **100–150 μ l** Mounting Medium to cover all tissue sections uniformly.
 - If **using** stopping point, add **100–150 μ l** Stopping Point Mounting Medium to cover all tissue sections uniformly.



Ensure that the appropriate Mounting Medium is used. Mounting Medium is prepared differently if using stopping points. Tissue slides with large sections or multiple sections may require more Mounting Medium.

- c. Slowly apply coverslip at an angle on one end of the slides, without introducing bubbles. Allow Mounting Medium to spread and settle.



DO NOT use Cytoseal or nail polish for securing the coverslip.

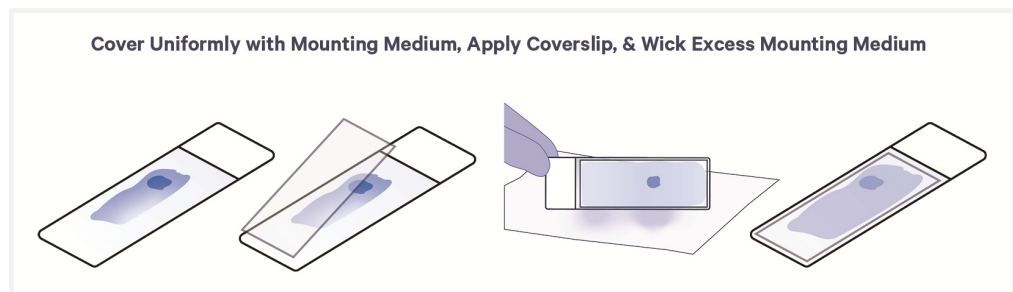

- d. Remove any large excess of Mounting Medium by carefully wicking away from the edge of the coverslip using a lint-free laboratory wipe. Do not move coverslip and disturb tissue.



- a. **Immediately** proceed with imaging or if Stopping Point Mounting Medium was used, store slides laying flat in a slide mailer or a slide holder. Store slides in the dark at **4°C** for up to **72 h**. Ensure that slides are laid flat to prevent loss of Mounting Medium.



Stopping points may only be used if staining guidance for stopping points was followed, which includes an RVC incubation and appropriate mounting media with RNase inhibitor.

If storing slides for longer is desired, **immediately** proceed with imaging and follow stop instructions in [2.6 Imaging on the next page](#). The stopping point after coverslip mounting and the stopping point in [2.6 Imaging on the next page](#) cannot be combined.

2.6 Imaging

- a. Image tissue section of interest at desired magnification using brightfield imaging settings. Consult the Visium HD Spatial Applications Imaging Guidelines Technical Note (CG000688) for additional information.
-  b. If slides were immediately imaged after coverslip mounting and Stopping Point Mounting Medium was used, slides may be stored in the dark at **4°C** for up to **1 week** prior to Coverslip Removal. Ensure that slides are laid flat to prevent loss of Mounting Medium.

Stopping points may only be used if staining guidance for stopping points was followed, which includes an RVC incubation.



DO NOT let the attached coverslip dry out.

- c. Proceed **immediately** to Coverslip Removal.

2.7 Coverslip Removal

- a. Dispense **800 ml** Milli-Q water in a beaker. Up to 10 slides may be processed using this beaker.
- b. Immerse slides sideways in the beaker containing **800 ml** water with coverslipped surface fully sideways to prevent coverslip from dragging across tissue.
- c. Hold slides in water until the coverslip slowly separates away from the slide.



To avoid tissue section damage or detachment, DO NOT move slide up and down, shake forcibly, or manually move coverslip.

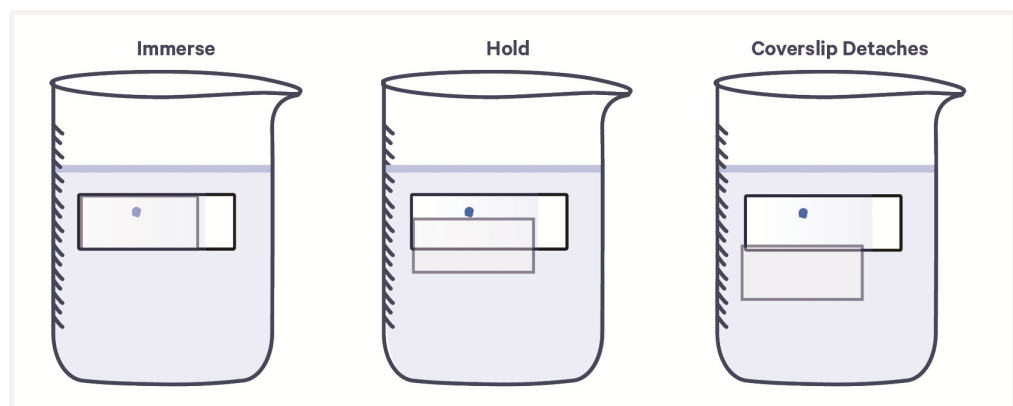

- d. Gently immerse slides 30x in water to ensure all Mounting Medium is removed.

- e. Wipe back of slide with a lint-free laboratory wipe.
- f. Place slide on a flat, clean, nonabsorbent work surface and air dry for **5 min**.
- g. Incubate slide on Low Profile Thermocycler Adapter with thermal cycler lid open for **3 min** at **37°C**. Ensure tissue is completely dry. If necessary, wipe droplets around tissue with a lint-free laboratory wipe.
- h. Proceed **immediately** to Destaining.

2.8 Destaining



Ensure 70% Methanol Mailer is pre-chilled on ice before proceeding to 2.9 Permeabilization on page 52.

- a. Place a Low Profile Thermocycler Adapter in the thermal cycler. Prepare thermal cycler with the following incubation protocol and start the program.

Lid Temperature	Reaction Volume	Run Time
42°C (lid may be set to lowest temperature if instrument does not enable 42°C)	100 µl	15 min

Step	Temperature	Time hh:mm:ss
Pre-equilibrate	42°C	Hold
Destaining	42°C	00:15:00
Hold	22°C	Hold

- b. Place slide in a Tissue Slide Cassette, centering the tissue or area of interest, and label the top of the cassette with tissue slide information.

See *Visium Cassette S3 Quick Reference Card (CG000730)* for assembly instructions. Practice assembly with a blank slide.

- c. Add **150 µl** 0.1 N HCl along the side of the wells to uniformly cover tissue sections, without introducing bubbles. Tap cassette gently to ensure uniform coverage.
- d. Remove HCl from wells.

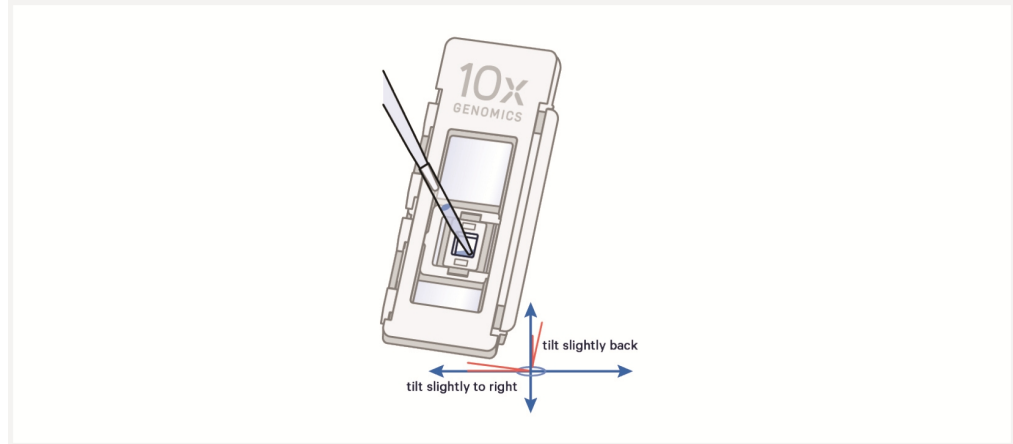

- e. Add **100 μ l** 0.1 N HCl along the side of the wells to uniformly cover tissue sections, without introducing bubbles. Tap cassette gently to ensure uniform coverage.
- TIPS** f. Apply pre-cut slide seal on cassette and place cassette on Low Profile Thermocycler Adapter at **42°C**. See Tips & Best Practices for more information on cassette incubation in a thermal cycler.

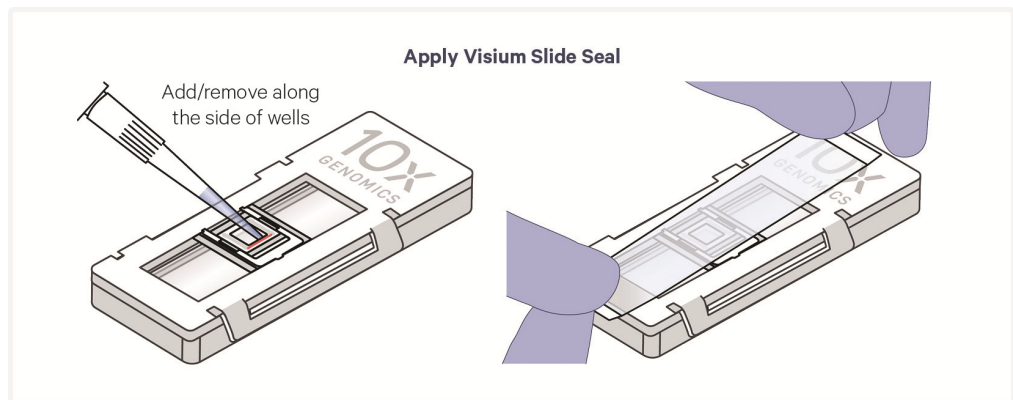

- g. Close thermal cycler lid. Skip Pre-equilibrate step to initiate Destaining.
- h. Remove cassette from Low Profile Thermocycler Adapter and place on a flat, clean work surface.
- !** *Some color remaining in the tissue after thermal cycler incubation is normal.*
- i. Peel back slide seal and using a pipette, remove all the HCl from well corners.

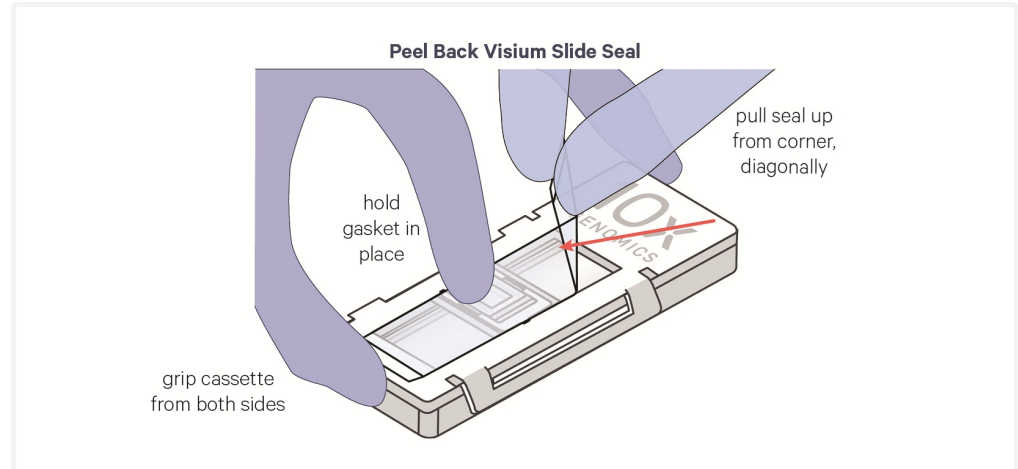

Three TE Buffer washes:

- j. Wash 1:** Add **150 µl** TE Buffer (pH 8.0) along the side of the wells. Incubate for **5 min** at **room temperature**. Remove TE Buffer from the wells.
- k. Wash 2:** Add **150 µl** TE Buffer (pH 8.0) along the side of the wells. Incubate for **5 min** at **room temperature**. Remove TE Buffer from the wells.
- l. Wash 3:** Add **150 µl** TE Buffer (pH 8.0) along the side of the wells. Incubate for **5 min** at **room temperature**. Remove TE Buffer from the wells.
- m.** Re-apply slide seal.

The slide seal will keep the gasket in place after the slide is removed. Ensure that cassette is labeled appropriately before moving on to next step to ensure that tissue orientation is not lost.

- n.** Remove slide from cassette. DO NOT allow slide to dry.
Store cassette in a clean, sealed bag or pipette tip box in a dry location. The cassette will be used at the end of the Permeabilization step.
- o.** Gently immerse slide in 1X PBS Mailer 1 and incubate for **1 min** at **room temperature**.

2.9 Permeabilization

- a.** Gently immerse slide in 1X PBS Mailer 2 and incubate for **1 min** at **room temperature**.
- b.** Gently immerse slide in 1% SDS Mailer and incubate for **2 min** at **room temperature**.

- c. Gently immerse slide in 1X PBS Mailer 3 and incubate for **1 min** at **room temperature**.
- d. Gently immerse slide in 1X PBS Mailer 4 and incubate for **1 min** at **room temperature**.
- e. Gently immerse slide in pre-chilled 70% Methanol Mailer and incubate for **60 min** on **ice**. Capped mailer should be fully submerged in ice up to lower part of pink cap. Replenish ice if necessary.

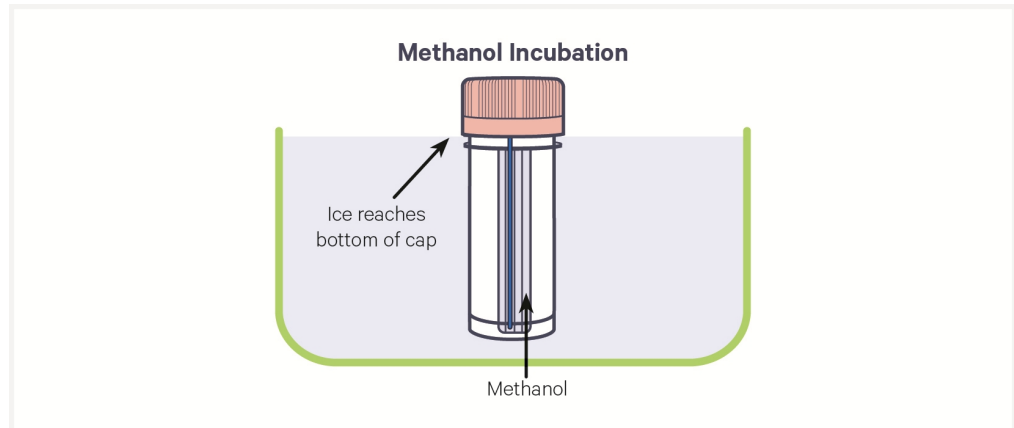

- f. Gently immerse slide in 1X PBS Mailer 5 for **1 min** at **room temperature**.
- g. Gently immerse slide in 1X PBS Mailer 6 for **1 min** at **room temperature**.
- h. Remove slide from 1X PBS Mailer 6.
- i. Reassemble slide into Tissue Slide Cassette from Destaining.
- j. Remove slide seal and add **100 μ l** 1X PBS along the side of the well.
- k. Apply a new pre-cut slide seal to cassette.
- l. Proceed immediately to Visium HD Spatial Gene Expression Reagent Kits User Guide (CG000685).

3. IF Staining & Imaging

Overview

This chapter provides guidance on fixation, permeabilization, immunofluorescence (IF) staining, coverslip mounting, imaging, and coverslip removal for tissue slides. These tissue slides should be prepared according to [1. Tissue Handling, Freezing, Embedding, Sectioning, Section Placement, and Quality Assessment on page 18](#) prior to starting this chapter. This chapter also provides guidance on optimizing antibodies. After coverslip removal, proceed immediately to the Visium HD Spatial Gene Expression User Guide (CG000685).

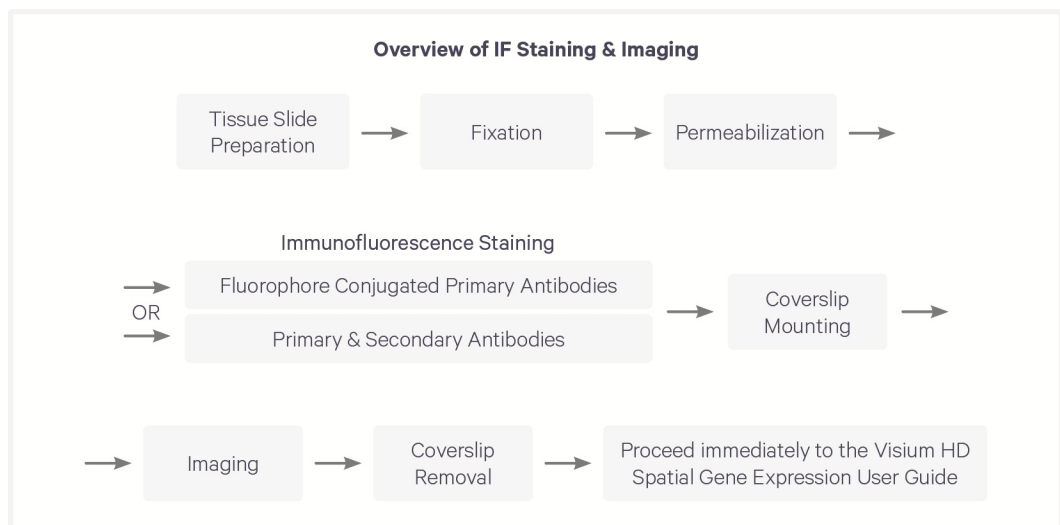

One additional Tissue Slide Cassette (Visium Tissue Slide Cassette S3 6.5 mm, 4 pk PN-1000684) is required for each processed Tissue Slide.

Verify microscope settings and create imaging programs prior to starting this step. Consult the Visium HD Spatial Applications Imaging Guidelines Technical Note (CG000688) for more information.

Separate protocols are provided in this chapter if fluorophore-conjugated primary antibodies are used vs. if primary and secondary antibodies are used.

- [3.5 Immunofluorescence Staining - Fluorophore Conjugated Primary Antibodies on page 71](#)
- [3.6 Immunofluorescence Staining - Primary & Secondary Antibodies on page 74.](#)

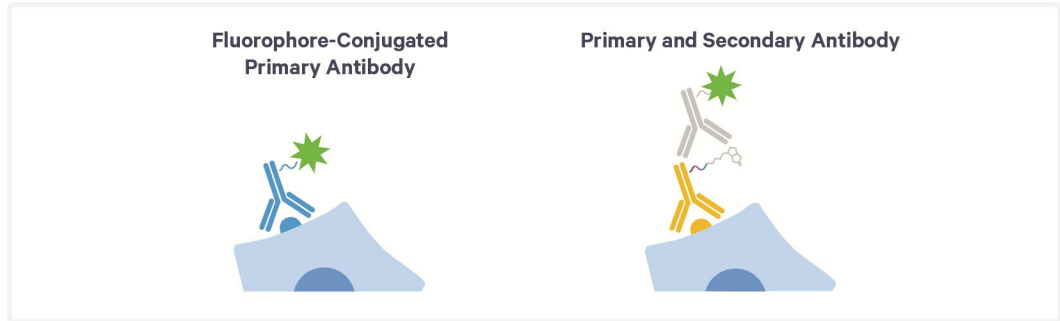

Antibody Optimization

Prior testing of the antibodies is recommended on the same tissue block before performing immunofluorescence staining in combination with the Visium HD Spatial Gene Expression workflow. Determination of the optimal antibody concentration is crucial for successfully executing this protocol.

 A Visium 8-port Cassette S3, 4 pk (PN-1000685) must be purchased to perform antibody optimization.

Optimal antibody concentrations for this Demonstrated Protocol may differ from other applications. Composition of reagents and buffers may also differ from other immunofluorescence applications.

When optimizing the antibody for a single tissue type, ensure that stained slides can be imaged according to the imaging guidelines listed in Visium HD Spatial Applications Imaging Guidelines Technical Note (CG000688).

Below is a suggested optimization workflow. Antibody optimization may be performed according to preference, as long as tissues are tested using the immunofluorescence staining protocol described in this document.

- Draw representative frames on the back of a blank slide using the example slide layout for a 25 mm wide slide.

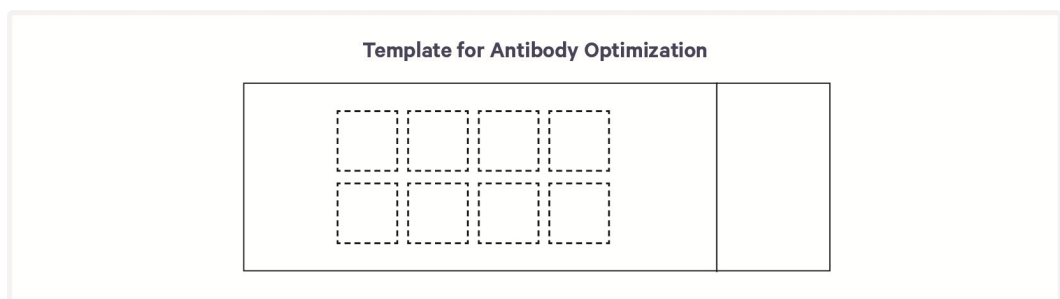

- Trim tissue sections to fit within each 6.5 mm area on the template.
- Place tissue sections in the frames on the front of the slide for compatibility with the Visium Cassette.
- Execute the Immunofluorescence Staining protocol using a range of antibody concentrations, testing multiple concentrations on the same tissue slide. A starting concentration of 0.01 $\mu\text{g}/\mu\text{l}$ (0.7 $\mu\text{g}/\text{sample}$) is recommended.
- To reduce autofluorescence, TrueBlack reagent may be added.
- Select the antibody concentration that results in the specific staining of desired cells, while minimizing nonspecific background staining.

Autofluorescence quenchers are added following immunofluorescence staining and may result in the reduction of fluorescence signal. Additional optimization and increase in antibody concentration may be required to properly visualize immunostaining.

An example dilution layout is provided below. DAPI and merged images are provided to show the presence of breast cancer tissue for each antibody dilution. Dilutions are of recombinant Anti-Vimentin antibody conjugated to Alexa Fluor 594 (BioLegend, PN677804, 0.5 mg/ml). A 1:100 dilution (0.35 $\mu\text{g}/\text{sample}$) was considered optimal in this example.

Example calculations:

Stock antibody concentration is 0.5 $\mu\text{g}/\mu\text{l}$ and desired concentration is 0.01 $\mu\text{g}/\mu\text{l}$ (50X dilution).

Reagents	Stock	Final	Volume (μl)
PBS	10X	1X	7.0
BSA	10%	2%	14.0
RNase Inhibitor	40 U/ μl	2 U/ μl	3.5
Tween-20	10%	0.1%	0.7
Antibody	0.5 $\mu\text{g}/\mu\text{l}$	0.01 $\mu\text{g}/\mu\text{l}$	1.4
DAPI Solution	100X	0.5X	0.4
Nuclease-free Water			43.0
Total			70.0

Stock antibody concentration is 0.5 $\mu\text{g}/\mu\text{l}$ and desired concentration is 0.0025 $\mu\text{g}/\mu\text{l}$ (200X dilution).

- This calculation requires pipetting a very small volume of antibody. Dilute the stock concentration first. In the example below, the stock antibody is

diluted 10X to 0.05 µg/µl. Proceed with the following reagent table:

Reagents	Stock	Final	Volume (µl)
PBS	10X	1X	7.0
BSA	10%	2%	14.0
RNase Inhibitor	40 U/µl	2 U/µl	3.5
Tween-20	10%	0.1%	0.7
Antibody	0.05 µg/µl*	0.0025 µg/µl	3.5
DAPI Solution	100X	0.5X	0.4
Nuclease-free Water			40.9
Total			70.0

*Diluted antibody stock

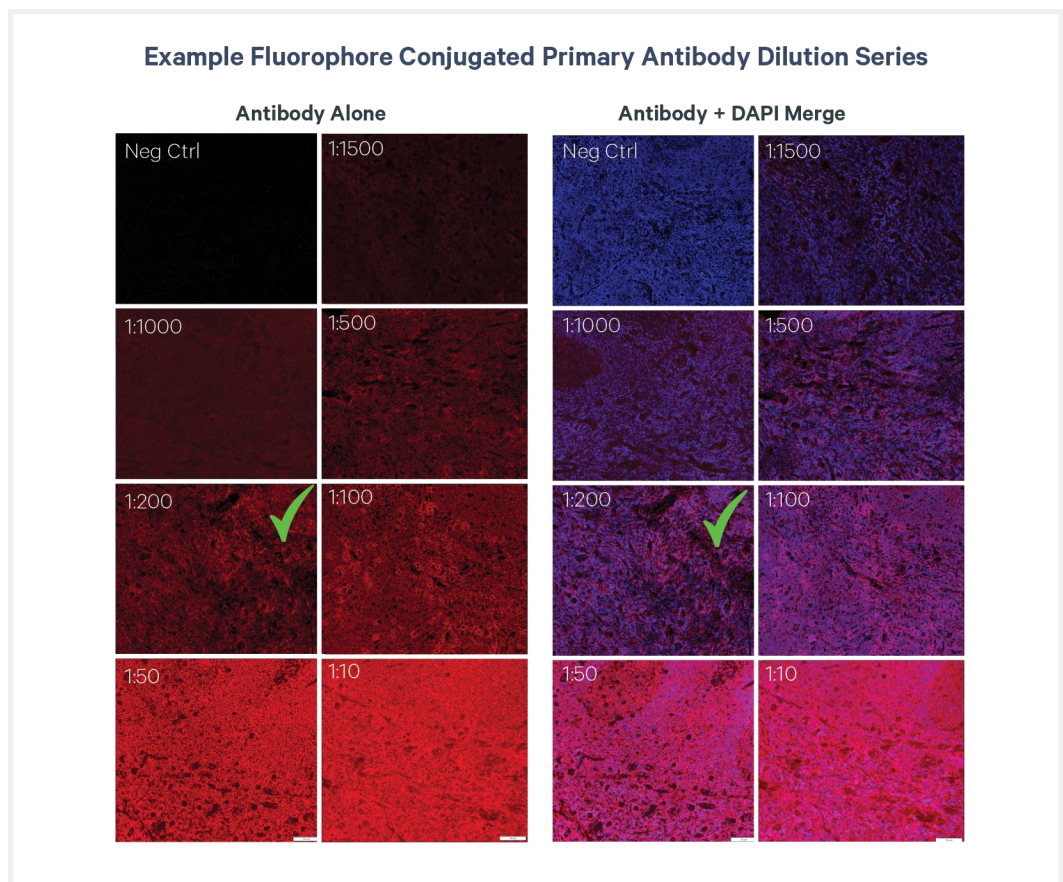

3.0 Preparation

Consult the Visium HD Spatial Gene Expression Protocol Planner (CG000698) for a list of third-party items. If using slide containers other than slide mailers (where applicable), reagent volumes will need to be scaled appropriately.



Washing tissue sections with RVC and adding RNase Inhibitor to mounting media is optional if tissue sections will be imaged and hybridized with probes on the same day. These RNA-protecting reagents are required for all supported stopping points in this document.

For All Steps

The amounts of buffer in this table are sufficient for all remaining steps in this chapter.

Items	Preparation & Handling
Prepare fresh.	
<input type="checkbox"/> 1X PBS	Prepare 900 ml 1X PBS. If using 10X stock, prepare 1X PBS using nuclease-free water.



Ensure that all solutions are prepared prior to removing tissue slides from **-80°C**.

For Fixation & Permeabilization

Items	Preparation & Handling
Obtain	
<input type="checkbox"/> Nuclease-free Water	-
<input type="checkbox"/> Formaldehyde or Paraformaldehyde	-
<input type="checkbox"/> 10% SDS	-
<input type="checkbox"/> Methanol	-
<input type="checkbox"/> Slide Mailers	-
<input type="checkbox"/> Forceps	-

Prepare fresh before retrieving slides from storage

- Fixation Solution** Using 1X PBS prepared above, prepare Fixation Solution using either Formaldehyde or Paraformaldehyde according to the appropriate table below. Formaldehyde and Paraformaldehyde should be handled in a biosafety hood due to their hazardous nature. Add reagents in the order listed. Invert gently to mix. Maintain at room temperature. DO NOT immerse more than two slides in a single slide mailer.

Fixation Solution (using formaldehyde)	Stock	Final	Total Amount (ml)
1X PBS	-	-	9.0
Formaldehyde	37%	3.7%	1.0
Total	-	-	10.0

OR

Fixation Solution (using paraformaldehyde)	Stock	Final	Total Amount (ml)
1X PBS	-	-	7.5
Paraformaldehyde	16%	4%	2.5
Total	-	-	10.0

- 1% SDS** Prepare 1% Sodium dodecyl sulfate (SDS). Verify no precipitate in SDS before use. Add reagents in the order listed. Invert gently to mix. Maintain at room temperature.

1% SDS	Stock	Final	Total Amount (ml)
Nuclease-free water	-	-	9.0
SDS	10%	1%	1.0
Total	-	-	10.0

- 70% Methanol** Prepare 70% Methanol. Add reagents in the order listed. Invert gently to mix. Maintain at room temperature until pre-chill (see "Prepare slide Mailers" below)

70% Methanol	Stock	Final	Total Amount (ml)
Methanol	100%	70%	7.0
Nuclease-Free Water	-	-	3.0
Total	-	-	10.0

IF Staining & Imaging

Items	Preparation & Handling
Prepare Slide Mailers. Process no more than two slides per mailer.	
<input type="checkbox"/> Fixation Solution	Label one slide mailer as Fixation Solution Mailer. Dispense 10 ml Fixation Solution.
<input type="checkbox"/> 1X PBS	Label six slide mailers as 1X PBS Mailer 1-6. Dispense 10 ml 1X PBS into each slide mailer.
<input type="checkbox"/> 1% SDS	Label one slide mailer as 1% SDS Mailer. Dispense 10 ml 1% SDS solution.
<input type="checkbox"/> 70% Methanol	Label one slide mailer as 70% Methanol Mailer. Dispense 10 ml 70% Methanol. Pre-chill 70% Methanol on ice for 30 min.

For IF Staining

Items	Preparation & Handling
Obtain	
<input type="checkbox"/> 1X PBS	Prepare one 50-ml centrifuge tube of 1X PBS for each tissue slide. If necessary, prepare 1X PBS from 10X stock using nuclease-free water.
<input type="checkbox"/> 10X PBS	-
<input type="checkbox"/> 70% Ethanol	Optional, if performing TrueBlack Quenching. Prepare 1 ml of 70% Ethanol by diluting stock ethanol with nuclease-free water.

Items	Preparation & Handling
<input type="checkbox"/> Wash Buffer	Prepare Wash Buffer according to the appropriate table below, adding reagents in the order listed. Pipette mix 10x and centrifuge briefly. Maintain on ice.

If using a fluorophore conjugated primary antibody:

Wash Buffer	Stock	Final	1X (µl)	2X +10% (µl)
<i>1X = 1 Tissue Slide Cassette Gasket</i>				
PBS	10X	1X	60.0	132.0
Tween-20	10%	0.4%	24.0	52.8
Nuclease-free Water	-	-	516.0	1,135.2
Total	-	-	600.0	1,320.0

If using a primary and secondary antibody:

Wash Buffer	Stock	Final	1X (µl)	2X +10% (µl)
<i>1X = 1 Tissue Slide Cassette Gasket</i>				
PBS	10X	1X	120.0	264.0
Tween-20	10%	0.4%	48.0	105.6
Nuclease-free Water	-	-	1,032.0	2,270.4
Total	-	-	1,200.0	2,640.0

<input type="checkbox"/> 1X Blocking Buffer	Prepare Blocking Buffer on ice according to the appropriate table below, adding reagents in the order listed. Pipette mix 10x and centrifuge briefly. Maintain on ice.
---	--

1X Blocking Buffer	Stock	Final	1X (µl)	2X +10% (µl)
PBS	10X	1X	10.0	22.0
BSA	10%	2%	20.0	44.0
RNase Inhibitor	40 U/µl	1 U/µl	2.5	5.5
Tween-20	10%	0.1%	1.0	2.2
Nuclease-free Water	-	-	66.5	146.3
Total	-	-	100.0	220.0

Optional Staining Reagents - Only Required if Using Stopping Point

Items	Preparation & Handling
<input type="checkbox"/> Ribonucleoside Vanadyl Complex (RVC)	Preparing aliquots: Incubate sealed vial at 65°C in a heating block, bead bath, or water bath for 20 min or until solution is reconstituted to a dark green solution with no visible particulates. Aliquot into single-use tubes (30 µl per slide). Store tubes at -20°C. DO NOT exceed 2 freeze-thaw cycles per aliquot. If using an aliquot immediately, no freezing is necessary. Store at room temperature until use. Gently invert every 10 min.

Using a frozen aliquot: remove aliquot from -20°C and incubate at 65°C for 10 min to remove precipitate.

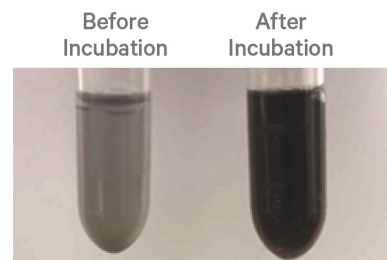

<input type="checkbox"/> RVC Working Solution	Prepare Ribonucleoside Vanadyl Complex stock as described above prior to generating working solution. Pipette mix. Maintain at room temperature.
---	--

RVC Working Solution <i>1 slide = 1 Tissue Slide</i>	Stock	Final	1 Slide (µl)	2 Slides +15% (µl)
1X PBS	-	-	497.5	1,144.2
Ribonucleoside Vanadyl Complex	200 mM	1 mM	2.5	5.8
Total	-	-	500.0	1,150.0

IF Staining & Imaging

For Coverslip Mounting

Items	Preparation & Handling																										
Prepare - Select One Mounting Medium																											
<input type="checkbox"/> Mounting Medium	Prepare this Mounting Medium if stopping point will not be used. Invert to mix. Briefly centrifuge to remove bubbles. Inspect for bubbles. Continue centrifuging until no bubbles remain. Maintain at room temperature.																										
	<table border="1"> <thead> <tr> <th>Mounting Medium 1 slide = 1 Tissue Slide</th> <th>Stock</th> <th>Final</th> <th>1 Slide (µl)</th> <th>2 Slides +15% (µl)</th> </tr> </thead> <tbody> <tr> <td>Glycerol</td> <td>100%</td> <td>80%</td> <td>120</td> <td>276</td> </tr> <tr> <td>Slowfade Diamond</td> <td>100%</td> <td>20%</td> <td>30</td> <td>69</td> </tr> <tr> <td>Total</td> <td>-</td> <td>-</td> <td>150</td> <td>345</td> </tr> </tbody> </table>	Mounting Medium 1 slide = 1 Tissue Slide	Stock	Final	1 Slide (µl)	2 Slides +15% (µl)	Glycerol	100%	80%	120	276	Slowfade Diamond	100%	20%	30	69	Total	-	-	150	345						
Mounting Medium 1 slide = 1 Tissue Slide	Stock	Final	1 Slide (µl)	2 Slides +15% (µl)																							
Glycerol	100%	80%	120	276																							
Slowfade Diamond	100%	20%	30	69																							
Total	-	-	150	345																							
<input type="checkbox"/> Stopping Point Mounting Medium	Prepare this Mounting Medium if stopping point will be used. Invert to mix. Briefly centrifuge to remove bubbles. Inspect for bubbles. Continue centrifuging until no bubbles remain. Maintain at room temperature.																										
	<table border="1"> <thead> <tr> <th>Stopping Point Mounting Medium 1 slide = 1 Tissue Slide</th> <th>Stock</th> <th>Final</th> <th>1 Slide (µl)</th> <th>2 Slides +15% (µl)</th> </tr> </thead> <tbody> <tr> <td>Glycerol</td> <td>100%</td> <td>75%</td> <td>112.5</td> <td>258.7</td> </tr> <tr> <td>Slowfade Diamond</td> <td>100%</td> <td>20%</td> <td>30.0</td> <td>69.0</td> </tr> <tr> <td>RNase Inhibitor</td> <td>40U/µl</td> <td>2U/µl</td> <td>7.5</td> <td>17.3</td> </tr> <tr> <td>Total</td> <td>-</td> <td>-</td> <td>150.0</td> <td>345.0</td> </tr> </tbody> </table>	Stopping Point Mounting Medium 1 slide = 1 Tissue Slide	Stock	Final	1 Slide (µl)	2 Slides +15% (µl)	Glycerol	100%	75%	112.5	258.7	Slowfade Diamond	100%	20%	30.0	69.0	RNase Inhibitor	40U/µl	2U/µl	7.5	17.3	Total	-	-	150.0	345.0	
Stopping Point Mounting Medium 1 slide = 1 Tissue Slide	Stock	Final	1 Slide (µl)	2 Slides +15% (µl)																							
Glycerol	100%	75%	112.5	258.7																							
Slowfade Diamond	100%	20%	30.0	69.0																							
RNase Inhibitor	40U/µl	2U/µl	7.5	17.3																							
Total	-	-	150.0	345.0																							
Obtain																											
<input type="checkbox"/> Coverslip	-																										

IF Staining & Imaging

Protocol Overview

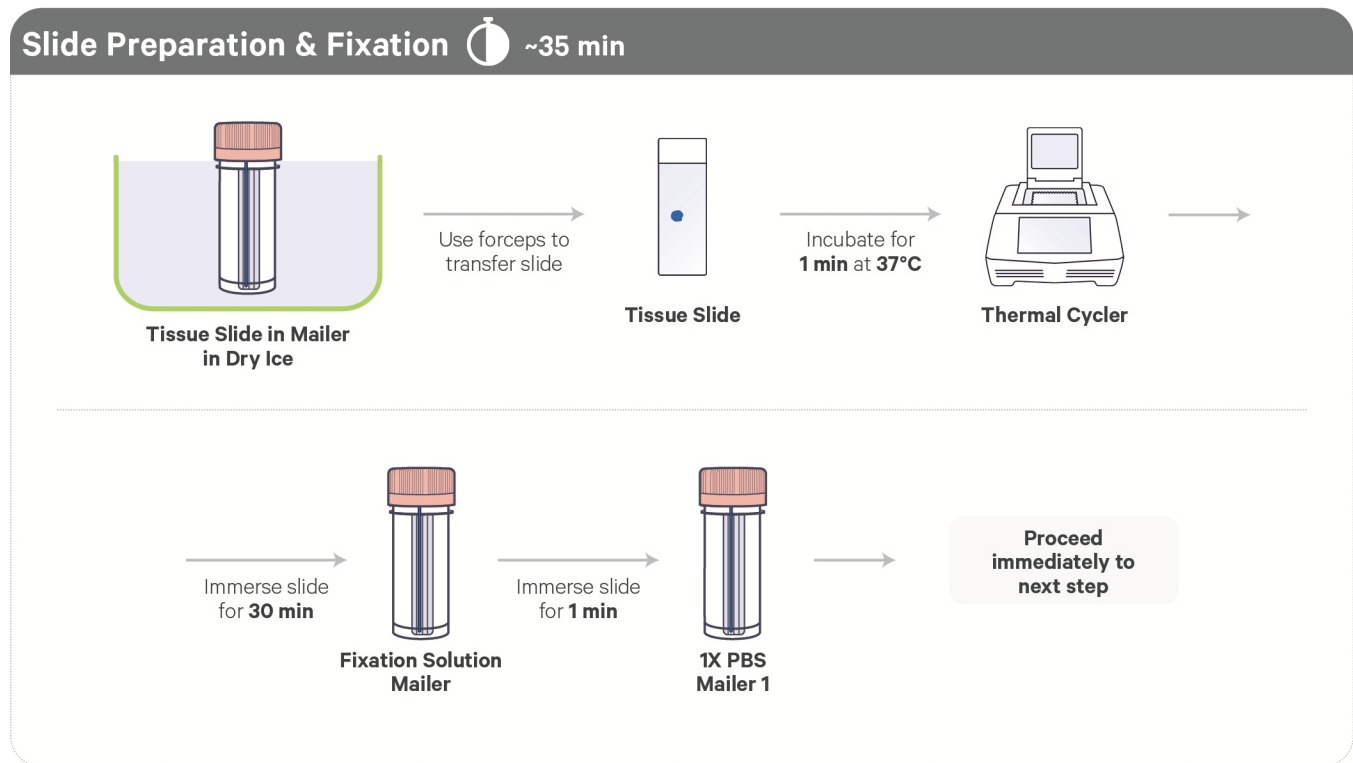

Permeabilization ~70 min

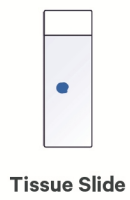

Immerse slide for 1 min

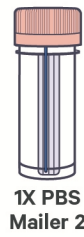

Immerse slide for 2 min

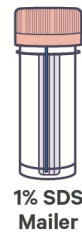

Immerse slide for 1 min

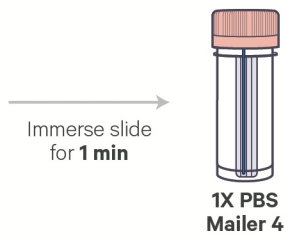
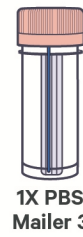

Immerse slide for 1 min

Immerse slide for 60 min

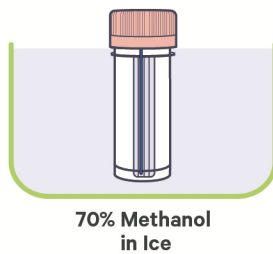

Immerse slide for 1 min

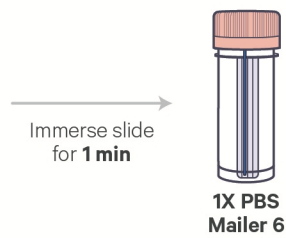
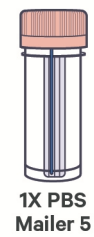

Immerse slide for 1 min

Proceed immediately to IF Staining

IF Staining & Imaging

Immunofluorescence Staining – Fluorophore Conjugated Primary Antibodies ~2 h

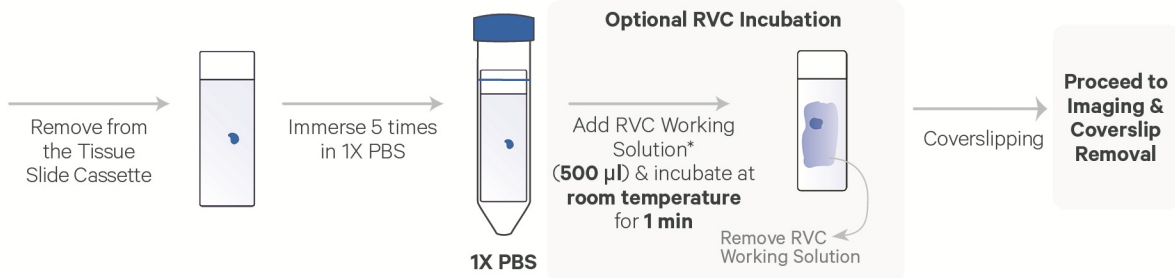
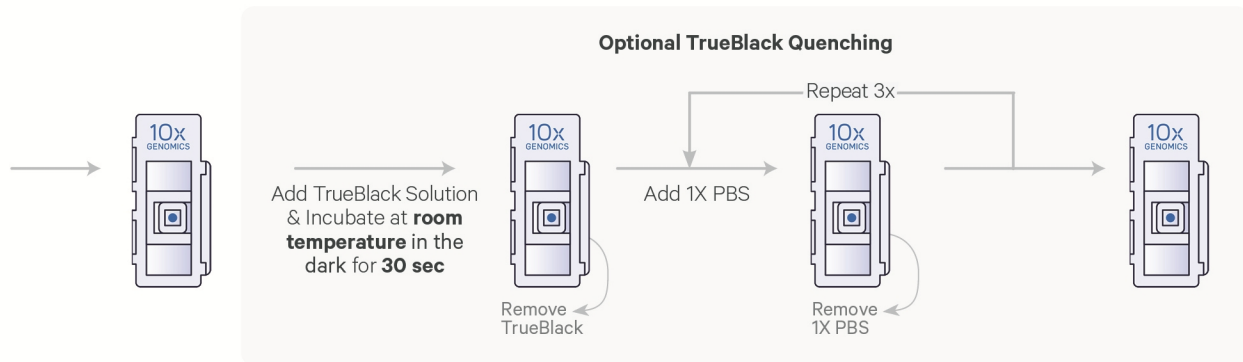
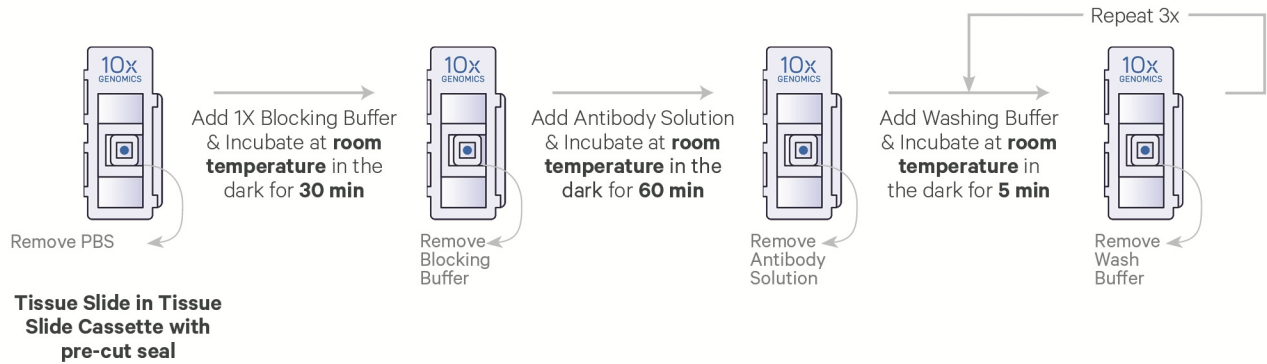

*Only required if using stopping points

IF Staining & Imaging

Immunofluorescence Staining – Primary & Secondary Antibodies ~2.5 h

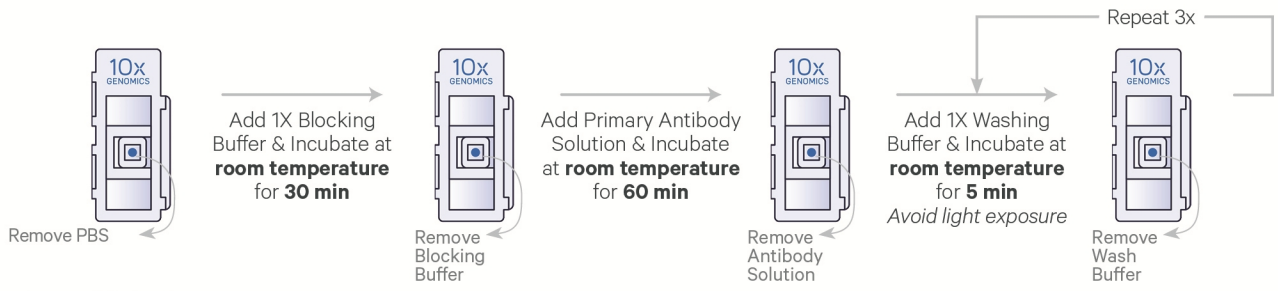

Tissue slide in Tissue Slide Cassette with a pre-cut seal

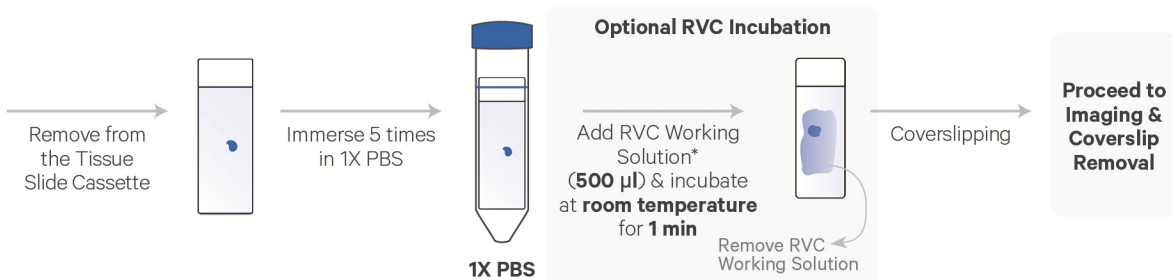
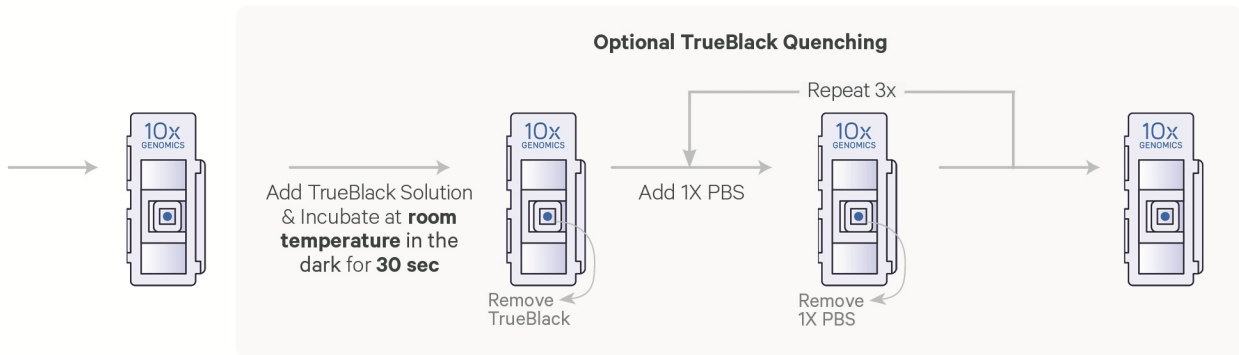
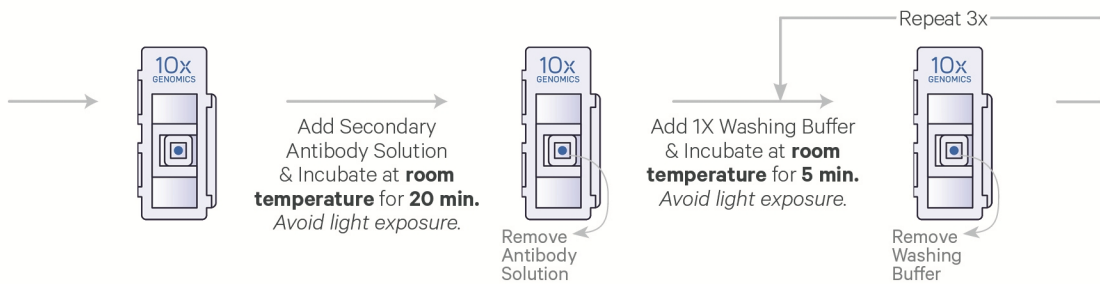

**Only required if using stopping points*

IF Staining & Imaging

3.1 Tissue Slide Preparation

- a. Place Low Profile Thermocycler Adapter in thermal cycler set to incubate at **37°C**. DO NOT close lid.

Prepare the Fixation Solution Mailer and a timer set to 1 min, which are needed in the following steps.

- b. Prepare a bucket of dry ice.
- c. Remove slide mailer containing stored fresh frozen tissue slides from **-80°C** and bury into the dry ice.

*Alternatively, submerge an uncapped empty slide mailer in dry ice and incubate for **5 min**. Remove slides from **-80°C** storage with forceps and immediately place in pre-chilled empty slide mailer on dry ice.*

- d. Using forceps, move slides from dry ice to the **37°C** pre-heated thermal cycler for **1 min**. Place slides on Thermocycler Adapter with tissue side facing up. Ensure Sample Area is aligned with the corresponding area on the Thermocycler Adapter. DO NOT close lid.

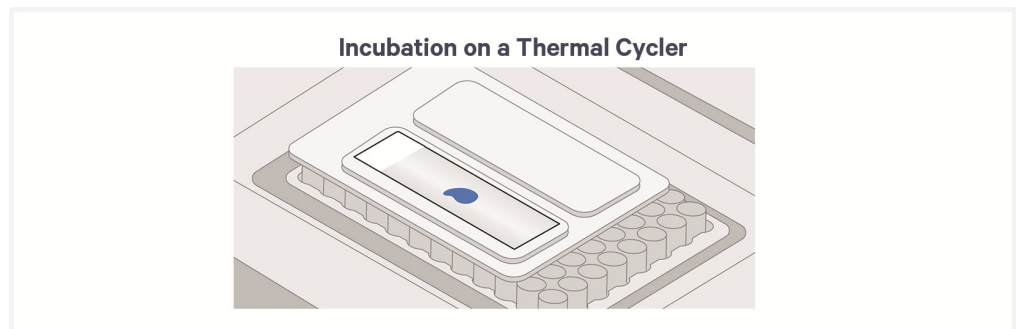

3.2 Fixation

- a. Immediately** remove slide from thermal cycler following incubation. Gently immerse slide in Fixation Solution Mailer using slide forceps and incubate for **30 min** at **room temperature**. Follow guidance in the illustration below for all steps where a slide is placed in a slide mailer.



DO NOT immerse more than two slides in a single slide mailer. Formaldehyde and Paraformaldehyde should be handled in a biosafety hood due to their hazardous nature. Transfer slides immediately to Fixation Solution after removal from thermal cycler to prevent freezing artifacts.



Ensure 70% Methanol Mailer is pre-chilled on ice, with ice completely covering the tube below the cap, before proceeding to next step. See [Tips & Best Practices](#) for guidance on immersing slides into mailers.

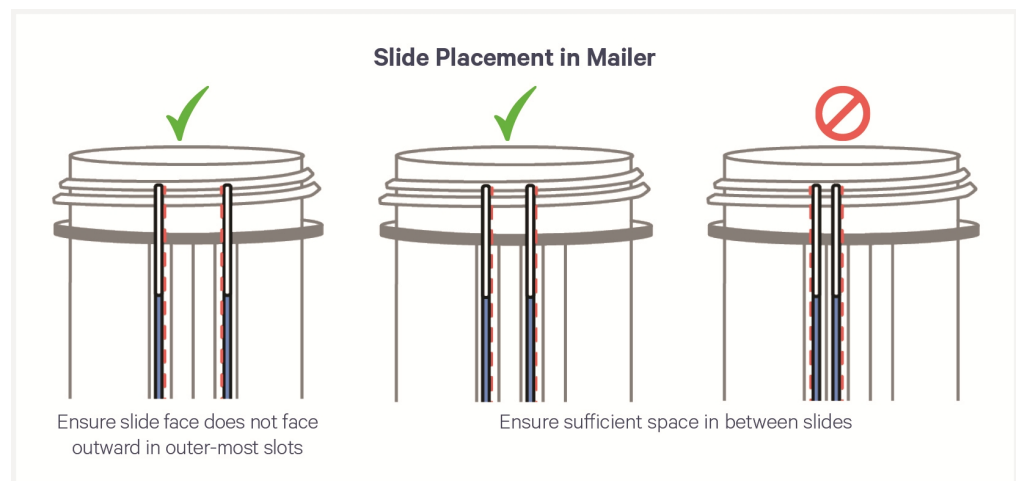
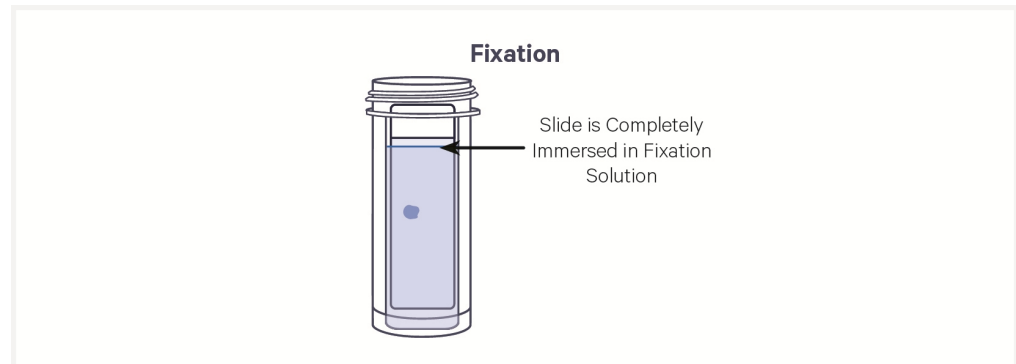

- b.** Remove slide from fixative and gently immerse slide in 1X PBS Mailer 1 and incubate for **1 min** at **room temperature**.

After 1X PBS incubation, remove any marker annotations using a lint-free laboratory wipe and 100% Ethanol.

3.3 Permeabilization

- a. Gently immerse slide in 1X PBS Mailer 2 and incubate for **1 min** at **room temperature**.
- b. Gently immerse slide in 1% SDS Mailer and incubate for **2 min** at **room temperature**.
- c. Gently immerse slide in 1X PBS Mailer 3 and incubate for **1 min** at **room temperature**.
- d. Gently immerse slide in 1X PBS Mailer 4 and incubate for **1 min** at **room temperature**.
- e. Gently immerse slide in pre-chilled 70% Methanol Mailer and incubate for **60 min** on **ice**. Capped mailer should be fully submerged in ice up to lower part of pink cap. Replenish ice if necessary.

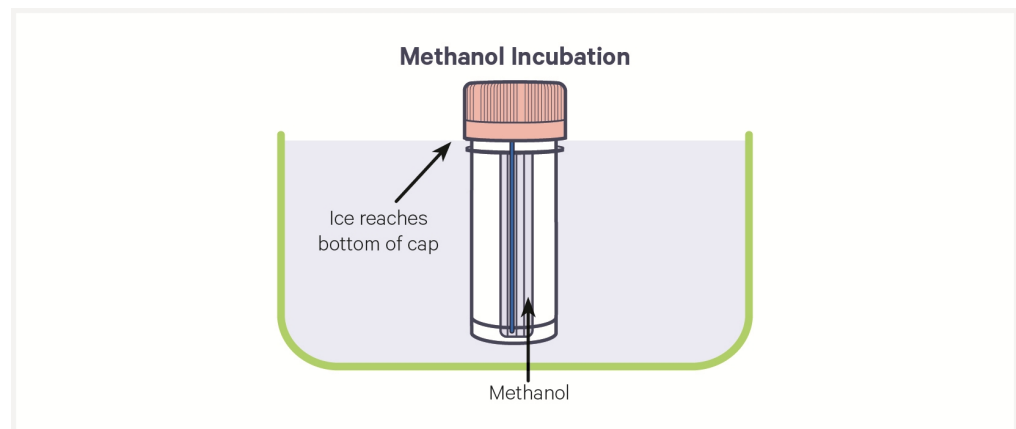

- f. Gently immerse slide in 1X PBS Mailer 5 for **1 min** at **room temperature**.
- g. Gently immerse slide in 1X PBS Mailer 6 for **1 min** at **room temperature**.
- h. Remove slide from 1X PBS Mailer 6.
- i. Place the slide in a Tissue Slide Cassette and label the top of the cassette with tissue slide information
See Visium Cassette S3 Quick Reference Card (CG000730) for assembly instructions. Practice assembly with a blank slide.
- j. Add **150 µl** 1X PBS along the side of the wells to uniformly cover the tissue sections, without introducing bubbles.
- k. Apply a pre-cut Visium Slide Seal on each Tissue Slide Cassette.
- l. Proceed immediately to appropriate immunofluorescence staining protocol.

3.4 Immunofluorescence Staining



Choose appropriate staining protocol depending upon the type of antibodies used. If using a primary and secondary antibody, proceed directly to [3.6 Immunofluorescence Staining - Primary & Secondary Antibodies](#) on page 74.



Antibody dilution may vary depending on the antibody, ranging from 1:50 down to 1:1000. Antibody volumes will depend on concentrations determined during antibody optimization.

3.5 Immunofluorescence Staining - Fluorophore Conjugated Primary Antibodies

- a. Prepare Antibody Solution on ice, adding reagents in the order listed. Pipette mix 10x and centrifuge briefly. Maintain on ice.

Antibody Solution	Stock	Final	1X (μl)	2X +10% (μl)	4X +10% (μl)
<i>1X = 1 Tissue Slide Cassette Gasket</i>					
PBS	10X	1X	7.0	15.4	30.8
BSA	10%	2%	14.0	30.8	61.6
RNase Inhibitor	40U/μl	2U/μl	3.5	7.7	15.4
Tween-20	10%	0.1%	0.7	1.5	3.1
Antibody #1	Variable	Variable	Variable	Variable	Variable
Antibody #2 (Optional)	Variable	Variable	Variable	Variable	Variable
Antibody #3 (Optional)	Variable	Variable	Variable	Variable	Variable
DAPI Solution	100X	0.5X	0.4	0.8	1.5
Nuclease-free Water	Variable	Variable	Variable	Variable	Variable
Total	-	-	70.0	154.0	308.0

- b. *Optional* - Prepare 1X TrueBlack Solution according to the appropriate table, adding reagents in the order listed. Pipette mix 10x and centrifuge briefly. Maintain at room temperature.

1X TrueBlack Solution	Stock	Final	1X (μ l)	2X +10% (μ l)	4X +10% (μ l)
<i>1X = 1 Tissue Slide Cassette Gasket</i>					
TrueBlack Lipofuscin Quencher	20X	1X	3.5	7.7	15.4
70% Ethanol	-	-	66.5	146.3	292.6
Total	-	-	70.0	154.0	308.0

- c. Peel back slide seal and remove all 1X PBS from wells.
- d. Add **100 μ l** 1X Blocking Buffer along the side of the wells.
- e. Re-apply Visium Slide Seal to Tissue Slide Cassette.
- f. Incubate for **30 min** at **room temperature**.
- g. Peel back slide seal and remove all Blocking Buffer from wells.
- h. Add **70 μ l** Antibody Solution along the side of the wells. Tap gently to ensure uniform coverage.
- i. Re-apply slide seal to cassette.
- j. Incubate for **1 h** at **room temperature** in the dark.
- k. Peel back slide seal and remove Antibody Solution.

Four Wash Buffer washes:

- l. **Wash 1:** Add **150 μ l** Wash Buffer along the side of the wells. Incubate for **5 min** at **room temperature**. Remove all Wash Buffer from wells.
- m. **Wash 2:** Add **150 μ l** Wash Buffer along the side of the wells. Incubate for **5 min** at **room temperature**. Remove all Wash Buffer from wells.
- n. **Wash 3:** Add **150 μ l** Wash Buffer along the side of the wells. Incubate for **5 min** at **room temperature**. Remove all Wash Buffer from wells.
- o. **Wash 4:** Add **150 μ l** Wash Buffer along the side of the wells. Incubate for **5 min** at **room temperature**. Remove all Wash Buffer from wells.
- p. *Optional* - TrueBlack Quenching
 - Add **70 μ l** 1X TrueBlack Solution along the side of the wells. Tap cassette gently to ensure uniform coverage.
 - Incubate for **30 sec** at **room temperature**.
 - Remove all 1X TrueBlack Solution from wells.

Four PBS washes:

- **Wash 1:** Add **150 µl** 1X PBS along the side of the wells. Remove all PBS from wells.
- **Wash 2:** Add **150 µl** 1X PBS along the side of the wells. Remove all PBS from wells.
- **Wash 3:** Add **150 µl** 1X PBS along the side of the wells. Remove all PBS from wells.
- **Wash 4:** Add **150 µl** 1X PBS along the side of the wells. Remove all PBS from wells.

q. Remove slide from cassette.



See Tips & Best Practices for removal instructions.

- r.** Gently immerse slide 5x in 1X PBS in 50-ml centrifuge tube. If processing multiple slides, use a separate 50-ml centrifuge tube filled with PBS for each slide.
- s.** Remove slide from PBS and place on a flat, clean, nonabsorbent work surface.
- t.** *Optional RNA protection - only if using pre or post-imaging stopping point*
 - Add **500 µl** RVC Working Solution per slide to uniformly cover all tissue sections.
 - Incubate **1 min** at **room temperature**.
 - Discard reagent by holding slides at an angle with the bottom edge in contact with a lint-free laboratory wipe and gently tapping the slide against the wipe.
- u.** Proceed immediately to Coverslip Mounting.

3.6 Immunofluorescence Staining - Primary & Secondary Antibodies

- a. Prepare Primary Antibody Solution on ice, adding reagents in the order listed. Pipette mix 10x and centrifuge briefly. Maintain on ice.

Primary Antibody Solution	Stock	Final	1X (μl)	2X +10% (μl)	4X +10% (μl)
<i>1X = 1 Tissue Slide Cassette Gasket</i>					
PBS	10X	1X	7.0	15.4	30.8
BSA	10%	2%	14.0	30.8	61.6
RNase Inhibitor	40U/μl	2U/μl	3.5	7.7	15.4
Tween-20	10%	0.1%	0.7	1.5	3.1
Antibody #1	Variable	Variable	Variable	Variable	Variable
Antibody #2 (Optional)	Variable	Variable	Variable	Variable	Variable
Antibody #3 (Optional)	Variable	Variable	Variable	Variable	Variable
Nuclease-free Water	Variable	Variable	Variable	Variable	Variable
Total	-	-	70.0	154.0	308.0

- b. Prepare Secondary Antibody Solution on ice, adding reagents in the order listed. Pipette mix 10x and centrifuge briefly. Maintain on ice.

Secondary Antibody Solution	Stock	Final	1X (μl)	2X +10% (μl)	4X +10% (μl)
<i>1X = 1 Tissue Slide Cassette Gasket</i>					
PBS	10X	1X	7.0	15.4	30.8
BSA	10%	2%	14.0	30.8	61.6
RNase Inhibitor	40U/μl	2U/μl	3.5	7.7	15.4
Tween-20	10%	0.1%	0.7	1.5	3.1
Antibody #1	Variable	Variable	Variable	Variable	Variable
Antibody #2 (Optional)	Variable	Variable	Variable	Variable	Variable
Antibody #3 (Optional)	Variable	Variable	Variable	Variable	Variable
DAPI Solution	100X	1X	0.7	1.5	3.1
Nuclease-free Water	Variable	Variable	Variable	Variable	Variable
Total	-	-	70.0	154.0	308.0



Antibody dilution can change depending on the antibody, ranging from 1:10 up

to 1:1500. Antibody volumes will depend on concentrations determined during antibody optimization.

- c. *Optional* - Prepare 1X TrueBlack Solution according to the appropriate table, adding reagents in the order listed. Pipette mix 10x and centrifuge briefly. Maintain at room temperature.

1X TrueBlack Solution	Stock	Final	1X (μ l)	2X +10% (μ l)	4X +10% (μ l)
<i>1X = 1 Tissue Slide Cassette Gasket</i>					
TrueBlack Lipofuscin Quencher	20X	1X	3.5	7.7	15.4
70% Ethanol	-	-	66.5	146.3	292.6
Total	-	-	70.0	154.0	308.0

- d. Peel back slide seal and remove all 1X PBS from wells.
- e. Add **100 μ l** 1X Blocking Buffer along the side of the wells.
- f. Re-apply Visium Slide Seal to Tissue Slide Cassette.
- g. Incubate for **30 min** at **room temperature**.
- h. Peel back slide seal and remove all Blocking Buffer from wells.
- i. Add **70 μ l** Primary Antibody Solution along the side of the wells. Tap gently to ensure uniform coverage.
- j. Re-apply slide seal to cassette.
- k. Incubate for **1 h** at **room temperature** in the dark.
- l. Peel back slide seal and remove Primary Antibody Solution.

Four Wash Buffer washes:

- m. **Wash 1:** Add **150 μ l** Wash Buffer along the side of the wells. Incubate for **5 min** at **room temperature**. Remove all Wash Buffer from wells.
- n. **Wash 2:** Add **150 μ l** Wash Buffer along the side of the wells. Incubate for **5 min** at **room temperature**. Remove all Wash Buffer from wells.
- o. **Wash 3:** Add **150 μ l** Wash Buffer along the side of the wells. Incubate for **5 min** at **room temperature**. Remove all Wash Buffer from wells.
- p. **Wash 4:** Add **150 μ l** Wash Buffer along the side of the wells. Incubate for **5 min** at **room temperature**. Remove all Wash Buffer from wells.

- q. Add **70 μ l** Secondary Antibody Solution along the side of the wells. Tap gently to ensure uniform coverage.
- r. Re-apply slide seal to cassette.
- s. Incubate for **20 min** at **room temperature** in the dark.
- t. Peel back slide seal and remove Secondary Antibody Solution.

Four Wash Buffer washes:

- u. **Wash 1:** Add **150 μ l** Wash Buffer along the side of the wells. Incubate for **5 min** at **room temperature**. Remove all Wash Buffer from wells.
- v. **Wash 2:** Add **150 μ l** Wash Buffer along the side of the wells. Incubate for **5 min** at **room temperature**. Remove all Wash Buffer from wells.
- w. **Wash 3:** Add **150 μ l** Wash Buffer along the side of the wells. Incubate for **5 min** at **room temperature**. Remove all Wash Buffer from wells.
- x. **Wash 4:** Add **150 μ l** Wash Buffer along the side of the wells. Incubate for **5 min** at **room temperature**. Remove all Wash Buffer from wells.
- y. *Optional* - TrueBlack Quenching

- Add **70 μ l** 1X TrueBlack Solution along the side of the wells. Tap cassette gently to ensure uniform coverage.
- Incubate for **30 sec** at **room temperature**.
- Remove all 1X TrueBlack Solution from wells.

Four PBS washes:

- **Wash 1:** Add **150 μ l** 1X PBS along the side of the wells. Remove all PBS from wells.
- **Wash 2:** Add **150 μ l** 1X PBS along the side of the wells. Remove all PBS from wells.
- **Wash 3:** Add **150 μ l** 1X PBS along the side of the wells. Remove all PBS from wells.
- **Wash 4:** Add **150 μ l** 1X PBS along the side of the wells. Remove all PBS from wells.
- z. Remove slide from cassette.



See Tips & Best Practices for removal instructions.

- aa. Gently immerse slide 5x in 1X PBS in a 50-ml centrifuge tube. If processing multiple slides, use a separate 50-ml centrifuge tube filled with PBS for each slide.

- ab.** Remove slide from PBS and place on a flat, clean, nonabsorbent work surface
- ac.** *Optional RNA Protection - only if using pre or post-imaging stopping point*
- Add **500 µl** RVC Working Solution per slide to uniformly cover all tissue sections.
 - Incubate **1 min** at **room temperature**.
 - Discard reagent by holding slides at an angle with the bottom edge in contact with a lint-free laboratory wipe and proceed immediately to Coverslip Mounting.

3.7 Coverslip Mounting

- a. Place slides on a flat, clean, nonabsorbent work surface. Some residual droplets may remain.
- b. Using a **wide-bore** pipette tip:
 - If **not** using stopping point, add **100–150 μ l** Mounting Medium to cover all tissue sections uniformly.
 - If **using** stopping point, add **100–150 μ l** Stopping Point Mounting Medium to cover all tissue sections uniformly.



Ensure that the appropriate Mounting Medium is used. Mounting Medium is prepared differently if using stopping points. Tissue slides with large sections or multiple sections may require more Mounting Medium.

- c. Slowly apply coverslip at an angle on one end of the slides, without introducing bubbles. Allow Mounting Medium to spread and settle.



DO NOT use Cytoseal or nail polish for securing the coverslip.

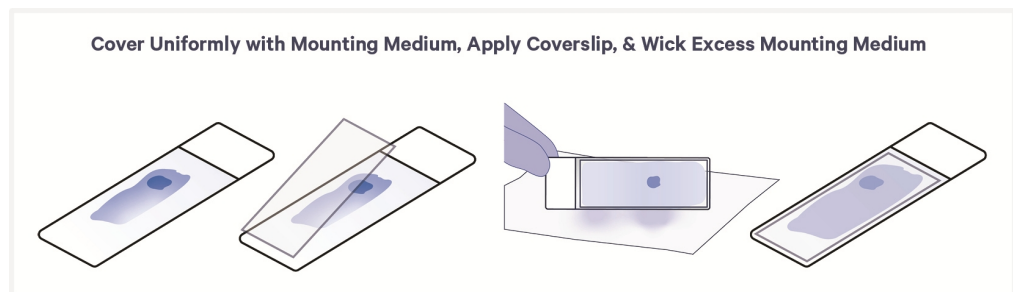

- d. Remove any large excess of Mounting Medium by carefully wicking away from the edge of the coverslip using a lint-free laboratory wipe. Do not move coverslip and disturb tissue.



- a. **Immediately** proceed with imaging or if Stopping Point Mounting Medium was used, store slides laying flat in a slide mailer or a slide holder. Store slides in the dark at **4°C** for up to **72 h**. Ensure that slides are laid flat to prevent loss of Mounting Medium.



Stopping points may only be used if staining guidance for stopping points was followed, which includes an RVC incubation and appropriate mounting media with RNase inhibitor.

If storing slides for longer is desired, **immediately** proceed with imaging and follow stop instructions in [3.8 Imaging on the next page](#). The stopping point after coverslip mounting and the stopping point in [3.8 Imaging on the next page](#) cannot be combined.

3.8 Imaging

- a. Image tissue section of interest at desired magnification using fluorescence imaging settings. Consult the Visium HD Spatial Applications Imaging Guidelines Technical Note (CG000688) for additional information.



- b. If slides were immediately imaged after coverslip mounting and Stopping Point Mounting Medium was used, slides may be stored in the dark at **4°C** for up to **1 week** prior to Coverslip Removal. Ensure that slides are laid flat to prevent loss of Mounting Medium.

Stopping points may only be used if staining guidance for stopping points was followed, which includes an RVC incubation.



DO NOT let the attached coverslip dry out.

- a. Proceed **immediately** to Coverslip Removal.

3.9 Coverslip Removal

- a. Dispense **800 ml** 1X PBS in a beaker. Up to 10 slides may be processed using this beaker.
- b. Immerse slides sideways in the beaker containing **800 ml** 1X PBS with coverslipped surface fully sideways to prevent coverslip from dragging across tissue.
- c. Hold slides in PBS until the coverslip slowly separates away from slide.



To avoid tissue section damage or detachment, DO NOT move slide up and down, shake forcibly, or manually move coverslip.

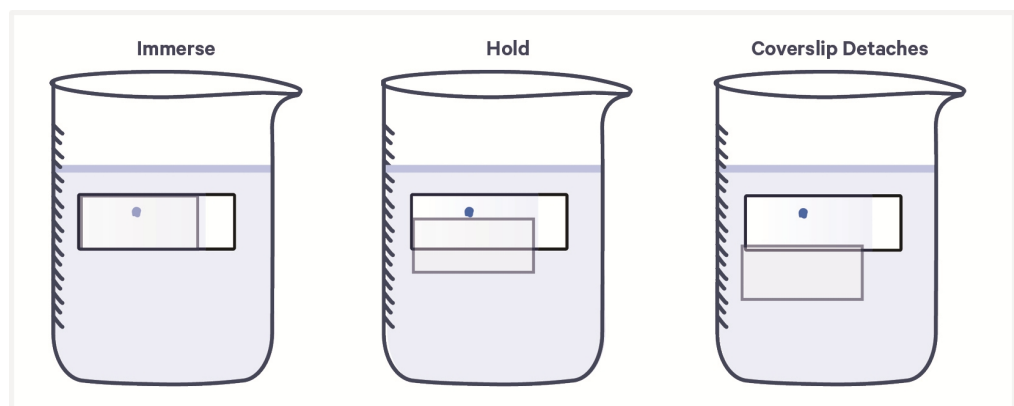

- d. Gently immerse slides 30x in 1X PBS to ensure all Mounting Medium is removed.
- e. Wipe back of slide with a lint-free laboratory wipe.

- f.** Place slide on a flat, clean, nonabsorbent work surface and air dry for **5 min.**
- g.** Place slide in a new Tissue Slide Cassette.
- h.** Add **100 μ l** 1X PBS along the side of the wells.
- i.** Apply a new pre-cut slide seal to cassette.
- j.** Proceed immediately to Visium HD Spatial Gene Expression Reagent Kits User Guide (CG000685).

Troubleshooting

Tissue Preparation Troubleshooting

Cryosectioning - Impact of Cryostat Specimen Head Temperatures on Tissue Tearing

-10°C

-14°C

-20°C

-30°C

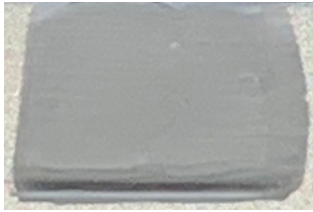

Normal Section



Tissue section has significant tearing.

Cryosectioning - Impact of Warm Tissue Block on Cryosectioning

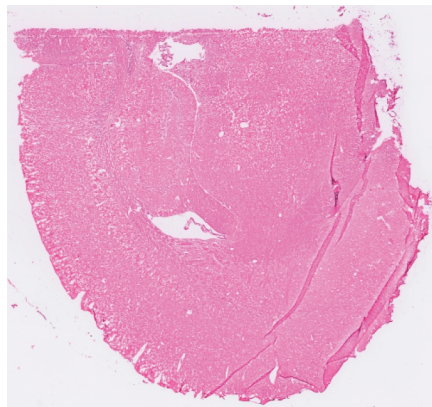

Folds in tissue are a result of warmer than optimal sectioning temperature.

Section Placement - Impact of Condensation on Tissue Sections

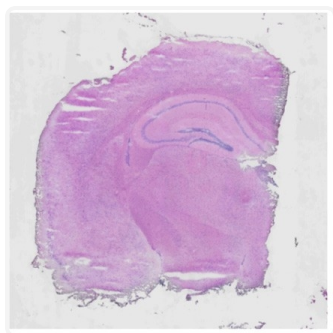

No Condensation. Intact tissue section.

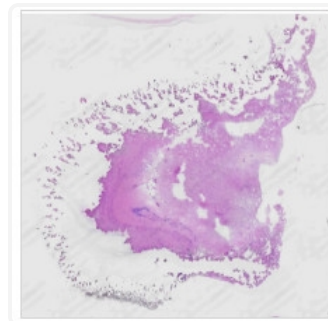

Tissue degraded due to condensation. DO NOT leave slides at room temperature, especially with fresh sections as the resulting condensation will cause tissue disintegration.

Section Placement - Incorrect Placement of Tissue Sections

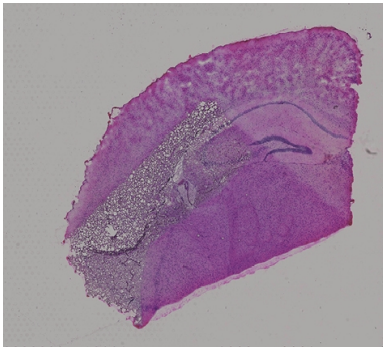

Folded tissue section

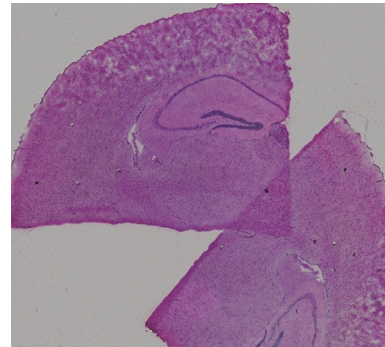

Overlapping sections

Practice correct section placement on blank slides.

H&E Staining Troubleshooting

Tissue Detachment

Ensure compatible blank slides are used to minimize tissue detachment. Consult the Visium HD Protocol Planner (CG000698). While detachment risks are lower with fresh frozen sections compared to FFPE sections, some tissue blocks with large amounts of connective tissue (like breast or colon) may result in sections with minor tissue detachment issues.

Bubbles

Avoid bubble formation during coverslip mounting. Bubbles can be mitigated by applying the coverslip at an angle and slowly lowering it onto the slide, allowing air to escape. Briefly centrifuge mounting medium to remove bubbles before use. Avoid introducing bubbles when pipetting mounting medium onto slide.

Bubbles may cause blackening of tissue.

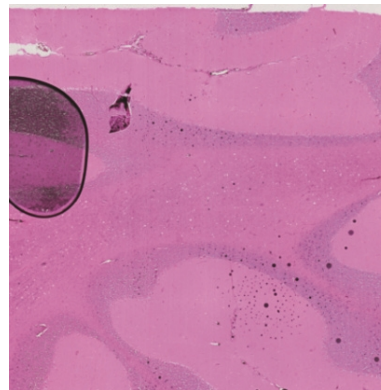

H&E Staining Troubleshooting

Uneven Staining

Causes

Ensure fresh staining reagents are applied to the tissue uniformly and adequate washes are performed. A gentle tap may help reagents spread uniformly. Consider filtering hematoxylin.

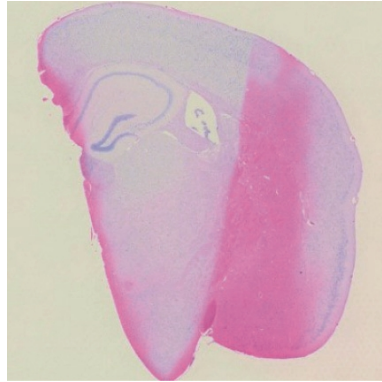

Uneven staining may also be caused by allowing slides to dry during staining. Ensure that slides do not air dry prior to coverslip mounting.

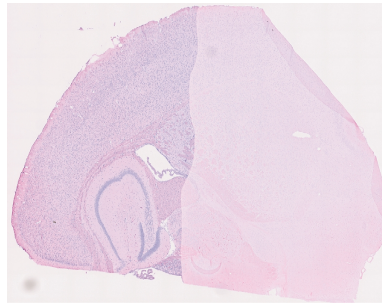

Incorrect Staining Protocol

The staining protocol in this handbook was optimized for tissues that will be processed with the Visium HD assay. Using an alternative H&E staining protocol may result in reduced staining performance.

In the mouse embryo examples below, the Visium HD H&E protocol results in better contrast between the hematoxylin (blue) stained nuclei and the eosin (pink) stained cytoplasm compared to the incorrect protocol.

Visium HD H&E Protocol

Incorrect Protocol

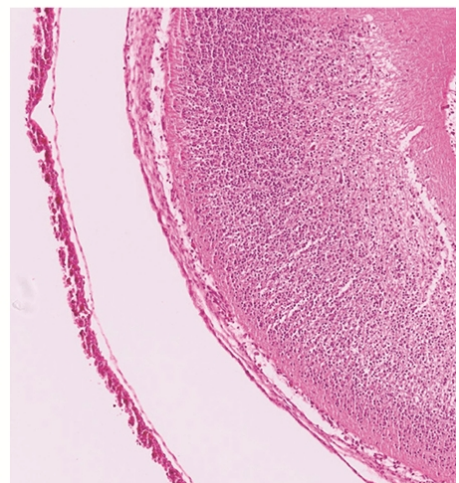
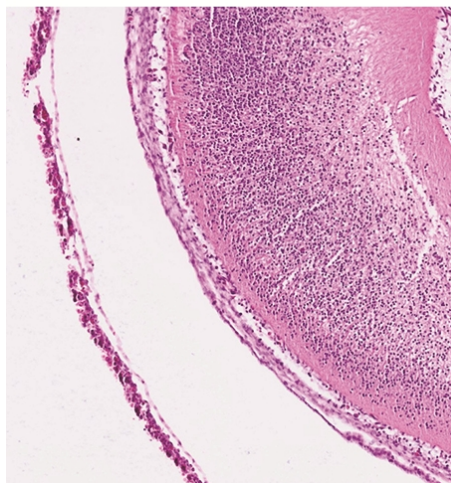

H&E Staining Troubleshooting

Inadequate RVC Working Solution Removal

Failure to remove RVC Working Solution from the slide may lead to Eosin leaching. In the images below, incubating tissue with RVC for longer than the recommended time has led to a loss in pink Eosin staining.

No Eosin Leaching

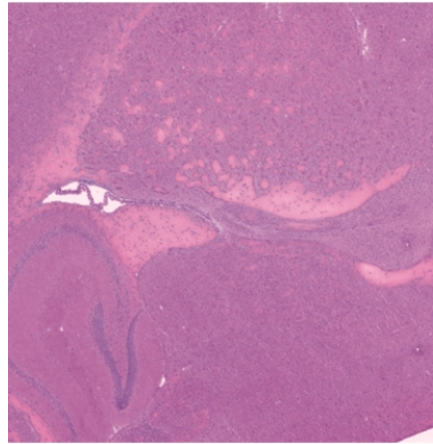

RVC-Induced Eosin Leaching

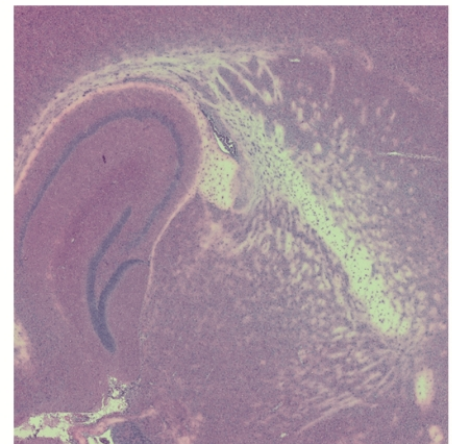

Tissue Section not washed with RVC Working Solution

RVC Working Solution is not required if stopping points in this Handbook will not be used. However, if stopping points will be used and tissue sections are not washed with RVC, a drop in assay sensitivity is likely.

IF Staining Troubleshooting

Weak Antibody Signal

Weak antibody signal in areas of the tissue where strong signal is expected may indicate that a nonideal concentration of antibody was used. Perform antibody optimization to determine the optimal concentration.

Good Signal - DAPI and Antibody Stain

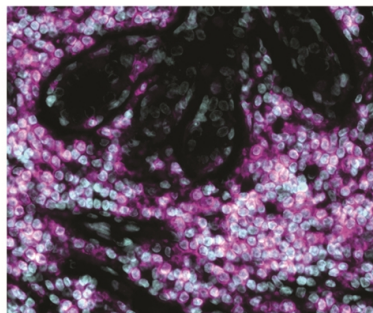

Good Signal - Antibody Stain Only

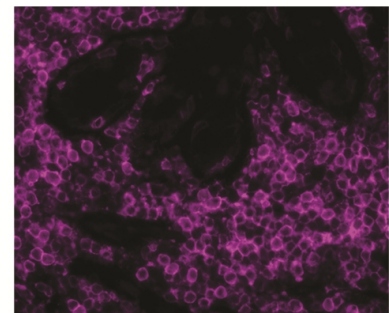

Weak Signal - DAPI and Antibody Stain

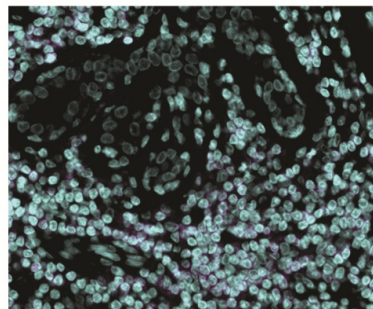

Weak Signal - Antibody Stain Only



Notices

Document Number

CG000763 | Rev B

Legal Notices

© 2025 10x Genomics, Inc. (10x Genomics). All rights reserved. Duplication and/or reproduction of all or any portion of this document without the express written consent of 10x Genomics, is strictly forbidden. Nothing contained herein shall constitute any warranty, express or implied, as to the performance of any products described herein. Any and all warranties applicable to any products are set forth in the applicable terms and conditions of sale accompanying the purchase of such product. 10x Genomics provides no warranty and hereby disclaims any and all warranties as to the use of any third-party products or protocols described herein. The use of products described herein is subject to certain restrictions as set forth in the applicable terms and conditions of sale accompanying the purchase of such product. A non-exhaustive list of 10x Genomics' marks, many of which are registered in the United States and other countries can be viewed at: www.10xgenomics.com/trademarks. 10x Genomics may refer to the products or services offered by other companies by their brand name or company name solely for clarity, and does not claim any rights in those third-party marks or names. 10x Genomics products may be covered by one or more of the patents as indicated at: www.10xgenomics.com/patents. The use of products described herein is subject to 10x Genomics Terms and Conditions of Sale, available at www.10xgenomics.com/legal-notices, or such other terms that have been agreed to in writing between 10x Genomics and user. All products and services described herein are intended FOR RESEARCH USE ONLY and NOT FOR USE IN DIAGNOSTIC PROCEDURES.

Instrument & Licensed Software Updates Warranties

Updates to existing Instruments and Licensed Software may be required to enable customers to use new or existing products.

Support

Email: support@10xgenomics.com

10x Genomics

6230 Stoneridge Mall Road

Pleasanton, CA

Document Revision Summary

Document Number

CG000763

Title

Visium HD FF Tissue Preparation Handbook

Revision

Rev B

Revision Date

January 24, 2025

Description of Changes

- Added information on simultaneous freezing & embedding in [1.2 Simultaneous Tissue Freezing & Embedding on page 27](#).
- Updated mounting medium titles and formulations in [2.1 Preparation on page 37](#) and [3.0 Preparation on page 58](#)
- Clarified that mounting medium with RNase inhibitor should be prepared if stopping point will be used [2.1 Preparation on page 37](#) and [3.0 Preparation on page 58](#)
- Updated RVC Working Solution formulation in [2.1 Preparation on page 37](#).
- Clarified that RVC incubation steps are optional in [2.4 H&E Staining on page 46](#), [3.5 Immunofluorescence Staining - Fluorophore Conjugated Primary Antibodies on page 71](#), and [3.6 Immunofluorescence Staining - Primary & Secondary Antibodies on page 74](#)
- Updated for general minor consistency of language and terms throughout.

Take 1 minute to evaluate this protocol. Scan this code or [click here](#).

