



[User Guide](#) | [CG000494](#) | [Rev D](#)

Visium

CytAssist Spatial Gene and Protein Expression Reagent Kits

For use with:

Visium CytAssist Spatial Gene Expression for FFPE, Human Transcriptome, 6.5 mm, 4 rxns PN-1000520

Visium CytAssist Spatial Gene Expression for FFPE, Human Transcriptome, 11 mm, 2 rxns PN-1000522

Visium CytAssist Protein Core Reagents PN-1000603

Visium Human Immune Cell Profiling Panel, Small PN-1000607

Visium CytAssist Reagent Accessory Kit, PN-1000499

Visium CytAssist Tissue Slide Cassette, 4 pk, 6.5 mm PN-1000471

Visium CytAssist Tissue Slide Cassette, 4 pk, 11 mm PN-1000472

Dual Index Kit TS Set A, 96 rxns PN-1000251

Dual Index Kit NT Set A, 96 rxns PN-1000242

Notices

Document Number

CG000494 | Rev D

Legal Notices

© 2024 10x Genomics, Inc. (10x Genomics). All rights reserved. Duplication and/or reproduction of all or any portion of this document without the express written consent of 10x Genomics, is strictly forbidden. Nothing contained herein shall constitute any warranty, express or implied, as to the performance of any products described herein. Any and all warranties applicable to any products are set forth in the applicable terms and conditions of sale accompanying the purchase of such product. 10x Genomics provides no warranty and hereby disclaims any and all warranties as to the use of any third-party products or protocols described herein. The use of products described herein is subject to certain restrictions as set forth in the applicable terms and conditions of sale accompanying the purchase of such product. A non-exhaustive list of 10x Genomics' marks, many of which are registered in the United States and other countries can be viewed at: www.10xgenomics.com/trademarks. 10x Genomics may refer to the products or services offered by other companies by their brand name or company name solely for clarity, and does not claim any rights in those third-party marks or names. 10x Genomics products may be covered by one or more of the patents as indicated at: www.10xgenomics.com/patents. The use of products described herein is subject to 10x Genomics Terms and Conditions of Sale, available at www.10xgenomics.com/legal-notices, or such other terms that have been agreed to in writing between 10x Genomics and user. All products and services described herein are intended FOR RESEARCH USE ONLY and NOT FOR USE IN DIAGNOSTIC PROCEDURES.

Instrument & Licensed Software Updates Warranties

Updates to existing Instruments and Licensed Software may be required to enable customers to use new or existing products.

Support

Email: support@10xgenomics.com

10x Genomics
6230 Stoneridge Mall Road
Pleasanton, CA

Document Revision Summary

Document Number

CG000494

Title

Visium CytAssist Spatial Gene and Protein Expression Reagent Kits User Guide

Revision

Rev D

Revision Date

July 16, 2024

Specific Changes

- Updated pre-hybridization mix formulation volumes in [2.1 Probe Hybridization on page 66](#).
- Updated pipette mix instructions in [6.2 Pre-Amplification Cleanup - SPRiselect on page 105](#).
- Updated TS Primer Mix B kit part number in [6.0 Get Started on page 102](#).
- Updated reagent addition and removal image in [5.2 Probe & Antibody Tag Extension on page 98](#).

General Changes

Updated for general minor consistency of language and terms throughout.

Table of Contents

Contents

Introduction

Reagent Kits	9
10x Genomics Accessories	14
Recommended Thermal Cyclers	14
Recommended Real Time qPCR Systems	15
Imaging System Recommendations	16
Additional Kits, Reagents & Equipment	17
Workflow Overview	20
Protocol Steps & Timing	21
Stepwise Objectives	23
Visium CytAssist Spatial Gene Expression Slides	24

Tips & Best Practices

General Reagent Handling	33
Visium Slide Storage	33
Pipette Calibration	33
Visium Spatial Slide Handling	33
Tissue Slide Handling	34
Visium CytAssist Tissue Slide Cassette	34
Visium CytAssist Tissue Slide Cassette Assembly	36
Visium CytAssist Tissue Slide Cassette Removal	37
Visium Cassette	38
Visium Cassette Assembly	40
Visium Cassette Removal	41
Reagent Addition to & Removal from Wells	42
Visium Slide Seal Application & Removal	43
Slide Incubation Guidance	45
10x Magnetic Separator	46
Magnetic Bead Cleanup Steps	47
SPRIselect Cleanup & Size Selection	47
Sample Indices (i5/i7) in Sample Index PCR	47

Table of Contents

Visium CytAssist	
Instrument Orientation	49
Visium CytAssist Tested Slides	50
Instrument Loading Guidelines	51
Sample Preparation & Staining Guidelines	
Sample Preparation	59
Step 1: DNase Treatment	
1.0 Get Started	61
1.1 DNase Treatment	62
Step 2: Probe Hybridization	
2.0 Get Started	65
2.1 Probe Hybridization	66
Step 3: Probe Ligation	
3.0 Get Started	71
3.1 Post-Hybridization Wash	72
3.2 Probe Ligation	74
3.3 Post-Ligation Wash	76
Step 4: Protein Labeling	
4.0 Get Started	79
4.1 Tissue Blocking	80
4.2 Antibody Incubation	81
4.3 Post-Antibody Incubation Wash	83
Step 5: Probe and Antibody Tag Release & Extension	
5.0 Get Started	86
5.1 CytAssist-Enabled RNA Digestion & Tissue Removal	88
5.2 Probe & Antibody Tag Extension	98
5.3 Probe & Antibody Tag Elution	99

Table of Contents

Step 6: Pre-Amplification and SPRIselect	
6.0 Get Started	102
6.1 Pre-Amplification	103
6.2 Pre-Amplification Cleanup - SPRIselect	105
6.3 Cycle Number Determination – qPCR	106
Step 7: Visium CytAssist Spatial Gene Expression – Probe-based Library Construction	
7.0 Get Started	110
7.1 GEX Sample Index PCR	111
7.2 GEX Post-Sample Index PCR Cleanup – SPRIselect	113
7.3 GEX Post-Library Construction QC	114
Step 8: Visium CytAssist Spatial Protein Expression Library Construction	
8.0 Get Started	116
8.1 Protein Sample Index PCR	117
8.2 Protein Post-Sample Index PCR Cleanup – SPRIselect	119
8.3 Protein Post-Library Construction QC	120
Sequencing	
Sequencing Libraries	122
Sequencing Depth	123
Sequencing Type & Run Parameters	125
Illumina Sequencer Compatibility	125
Sample Indices	125
Library Loading	126
Library Pooling	126
Sequencing Metrics	127
Troubleshooting	
Before CytAssist Instrument Run	132
During CytAssist Instrument Run	136
After CytAssist Instrument Run	138

Table of Contents

Issues Impacting Tissue Analysis	141
Appendix	
Post Library Construction Quantification	145
Agilent TapeStation Traces	146
LabChip Traces	147
Oligonucleotide Sequences	148

Introduction

Reagent Kits	9
10x Genomics Accessories	14
Recommended Thermal Cyclers	14
Recommended Real Time qPCR Systems	15
Imaging System Recommendations	16
Additional Kits, Reagents & Equipment	17
Workflow Overview	20
Protocol Steps & Timing	21
Stepwise Objectives	23
Visium CytAssist Spatial Gene Expression Slides	24

Reagent Kits

Visium CytAssist Spatial Gene Expression for FFPE Reagent Kits

Reagent Kits	Part Number	Components	Component Part Number	Quantity
Visium CytAssist Spatial Gene Expression for FFPE, Human Transcriptome, 6.5 mm, 4 rxns*	1000520	Visium CytAssist Slide and Cassettes, 6.5 mm, 2 rxns	PN-1000519	2
		Visium FFPE Reagent Kit v2 - Small	PN-1000436	1
		Visium Human Transcriptome Probe Kit v2 - Small	PN-1000466	1
Visium CytAssist Spatial Gene Expression for FFPE, Human Transcriptome, 11 mm, 2 rxns**	1000522	Visium CytAssist Slide and Cassettes, 11 mm, 2 rxns	PN-1000518	1
		Visium FFPE Reagent Kit v2 - Small	PN-1000436	1
		Visium Human Transcriptome Probe Kit v2 - Small	PN-1000466	1

*Also available in a pack of 4 as a 16 rxn kit.

**Also available in a pack of 4 as an 8 rxn kit.

Visium CytAssist Slide and Cassettes, 6.5 mm, 2 rxns PN-1000519

Visium CytAssist Slide and Cassettes, 6.5mm 2 rxns PN-1000519 (store at ambient temperature)		
	#	PN
Visium Cassette, 8 port	1	3000811
Visium Tissue Slide Cassette		
Visium CytAssist Sliding Gasket, Small (preassembled with translator)	2	3000814
Visium CytAssist Cassette Movable Translator (preassembled with gasket)	2	3000816
Visium CytAssist Cassette Movable Frame	2	3000813
Visium Slide Seals, 20-pack	1	2000284
Visium CytAssist Spatial Gene Expression Slide v2, 6.5 mm	1	2000549



Visium CytAssist Slide and Cassettes, 11 mm, 2 rxns PN-1000518

Visium CytAssist Slide and Cassettes, 11mm 2 rxns PN-1000518 (store at ambient temperature)		
	#	PN
Visium Cassette, 2 port	1	3000812
Visium Tissue Slide Cassette		
Visium CytAssist Sliding Gasket, Large	2	3000815
Visium CytAssist Cassette Movable Frame	2	3000813
Visium Slide Seals, 20-pack	1	2000284
Visium CytAssist Spatial Gene Expression Slide v2, 11 mm	1	2000550



Visium CytAssist Tissue Slide Cassette, 6.5 mm, 4 Cassettes PN-1000471

Visium CytAssist Tissue Slide Cassette, 6.5mm 4 Cassettes PN-1000471 (store at ambient temperature)		
	#	PN
Visium CytAssist Sliding Gasket, Small (preassembled with translator)	4	3000814
Visium CytAssist Cassette Movable Translator (preassembled with gasket)	4	3000816
Visium CytAssist Cassette Movable Frame	4	3000813



Visium CytAssist Tissue Slide Cassette, 11 mm, 4 Cassettes PN-1000472

Visium CytAssist Tissue Slide Cassette, 11mm 4 Cassettes PN-1000472 (store at ambient temperature)		
	#	PN
Visium CytAssist Sliding Gasket, Large	4	3000815
Visium CytAssist Cassette Movable Frame	4	3000813







Visium Human Immune Cell Profiling Panel* – Small, PN-1000607

Visium Human Immune Cell Profiling Panel - Small PN-1000607 (store at -20°C)		
	#	PN
Human FFPE Immune Profiling Panel, Small	2	2000699



*Each Visium Humane Immune Cell Profiling Panel, Small provides enough reagent for four 6.5 mm reactions or two 11 mm reactions.











Visium CytAssist Protein Core Reagents*, PN-1000603

Visium CytAssist Protein Core Reagents			
PN-1000603			
(store at -20°C)			
		#	PN
	DNase	1	2000881
	DNase Buffer	1	2000882
	RNase Inhibitor	1	2000556
	RNase Buffer C	1	2000883
	NT Primer Mix A	1	2000540

10x
GENOMICS™

*Each Visium CytAssist Protein Core Reagents Kit provides enough reagent for four 6.5 mm reactions or two 11 mm reactions.

Visium FFPE Reagent Kit v2 – Small, PN-1000436

Visium FFPE Reagent Kit – Small			
PN-1000436			
(store at -20°C)			
		#	PN
	Amp Mix B	1	2000567
	Extension Enzyme	1	2000389
	Extension Buffer	1	2000409
	RNase Enzyme	1	3000593
	RNase Buffer B**	1	2000551
	Tissue Removal Enzyme	1	3000387
	Tissue Removal Buffer B*	1	2000543
	Tissue Removal Buffer Enhancer*	1	2000557
	Decrosslinking Buffer	1	2000566
	TS Primer Mix B	1	2000537
	Block and Stain Buffer	2	2000554

10x
GENOMICS™

*These tubes may not be included in the kit. They are not used in this assay.

**This tube is not used in this assay.

Visium Human Transcriptome Probe Kit v2 - Small, PN-1000466

Visium Human Transcriptome Probe Kit v2 - Small PN-1000466 (store at -20°C)			
		#	PN
<input type="radio"/>	FFPE Hyb Buffer	1	2000423
<input type="radio"/>	FFPE Post-Hyb Wash Buffer	1	2000424
<input checked="" type="radio"/>	Human WT Probes v2 - RHS	1	2000657
<input checked="" type="radio"/>	Human WT Probes v2 - LHS	1	2000658
<input type="radio"/>	Probe Ligation Enzyme	1	2000425
<input type="radio"/>	2X Probe Ligation Buffer	1	2000445
	Post Ligation Wash Buffer	1	2000419



Dual Index Kit TS Set A, 96 rxns PN-1000251

Dual Index Kit TS Set A 96 rxns PN-1000251 (store at -20°C)		
	#	PN
Dual Index Plate TS Set A	1	3000511

Dual Index Kit NT Set A, 96 rxns PN-1000242

Dual Index Kit NT Set A 96 rxns PN-1000242 (store at -20°C)		
	#	PN
Dual Index Plate NT Set A	1	3000483

10x Genomics Accessories

Product	#	Part Number (Kit)	Part Number (Item)
10x Magnetic Separator	1	1000499 (Visium CytAssist Reagent Accessory Kit)	230003 or 2000431
Low Profile Thermocycler Adapter	2		3000823

Recommended Thermal Cyclers

Supplier	Description	Part Number
Bio-Rad	C1000 Touch Thermal Cycler with 96-Deep Well Reaction Module (discontinued)	1851197
	PTC Tempo Deepwell Thermal Cycler*	12015392
Eppendorf	MasterCycler Pro (discontinued)	North America 950030010 International 6321 000.019
	MasterCycler X50s	North America 6311000010
Thermo Fisher Scientific	Veriti 96-Well Thermal Cycler (discontinued)	4375786
	VeritiPro Thermal Cycler, 96-well**	A48141
Analytik Jena	Biometra TAdvanced 96 SG with 96-well block (silver, 0.2 mL) and gradient function	846-x-070-241 (where x=2 for 230 V; 4 for 115 V; 5 for 100 V, 50-60 Hz)

*If used with a single cassette, place the cassette on the side of the adapter furthest away from the thermal cycler hinge to prevent lid lock errors.

**Requires firmware 1.2.0 or later. Open lid slowly to avoid disturbing the cassette. After incubation, if the cassette becomes stuck to the lid, remove carefully. When working with tubes, VeritiPro requires blue MicroAmp 96-Well Tray/Retainer Set for VeritiSystems (PN-4381850), with top piece removed.



Ramp rates should be adjusted for all the steps as described below for the following thermal cyclers:

- Eppendorf MasterCycler X50s: 3°C/sec heating and 2°C/sec cooling
- Analytik Jena Biometra TAdvanced: 2°C/sec heating and cooling

Thermal cycler requirements if reactions are performed on a tube:

- Uniform heating of 100 ul volumes
- Temperature-controlled lid
- 96 deep-well block or 0.2 ml block configuration

Thermal cycler requirements if reactions are performed on a slide:

- The thermal cycler must be able to accommodate the low profile plate insert (also referred to as the Low Profile Thermocycler Adapter):
 - Well depth: 4.5 mm
 - Distance between block and heated lid: 12 mm
 - Reaction block dimensions: 95.5 x 73 mm
- The Low Profile Thermocycler Adapter may be difficult to remove from some thermal cyclers. If this is the case, turn off the thermal cycler and place a -20°C cooling pad on top of the Low Profile Thermocycler Adapter for a few minutes before attempting removal. Do not handle the Low Profile Thermocycler Adapter while it is hot.

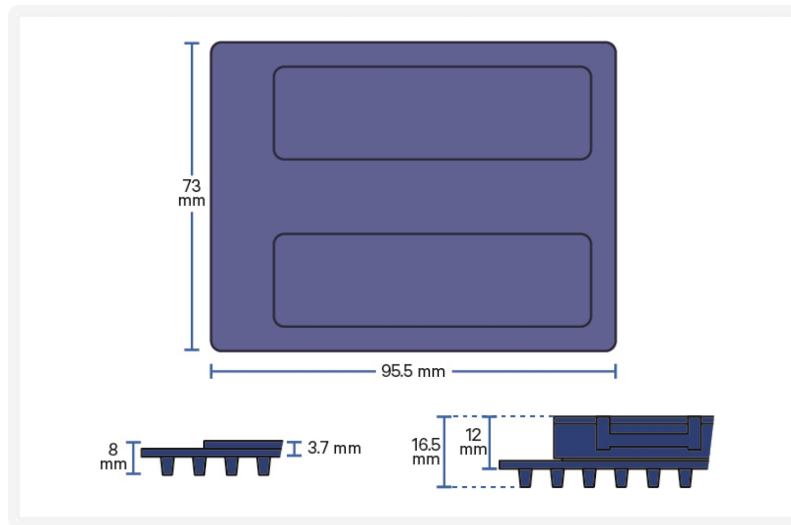

Recommended Real Time qPCR Systems

Supplier	Description	Part Number
Applied Biosystems	QuantStudio 12K Flex system	4471087
Bio-Rad	CFX96 Real-time System (discontinued)	1855096

Imaging System Recommendations

The imaging systems listed below were used by 10x Genomics. Any equivalent system with the listed features may be used for imaging. Consult the Visium CytAssist Spatial Applications Imaging Guidelines Technical Note (CG000521) for more information.

Imaging Systems & Specifications		
Microscopes (Any equivalent system with the listed features may be used for imaging)		
Supplier	Model	Configuration
Thermo Fisher Scientific	EVOS M7000	Inverted
Leica	Aperio Versa 8	Upright
	Leica DMI8	Inverted
MetaSystems	Metafer	Upright
Nikon	Nikon Eclipse Ti2	Inverted
BioTek	Cytation 7	Inverted or Upright
Keyence	Keyence BZX800	Inverted
Olympus	VS200	Upright
Zeiss	Imager.Z2	Upright
Microscope Features		
Objectives	<ul style="list-style-type: none"> 10X (NA 0.45) 20X (NA 0.75) 40X (NA 0.95) 	
Brightfield Features (for H&E staining)	<ul style="list-style-type: none"> Color camera (3 x 8 bit, 2,424 x 2,424 pixel resolution) White balancing functionality Minimum Capture Resolution 2.18 $\mu\text{m}/\text{pixel}$ Exposure times 2-10 milli sec 	
Fluorescence Features (for IF Staining)	<ul style="list-style-type: none"> Light source (or equivalent) with a wavelength range of 380–680 nm Monochrome camera (14 bit, 2,424 x 2,424 pixel resolution) DAPI filter cube (Excitation 392/23, Emission 447/60) FITC filter cube (Excitation 466/40, emission 515/30) Cy5 filter cube (Excitation 618/50, Emission 698/70) TRITC filter cube (Excitation 542/20, Emission 620/52) Minimum Capture Resolution 2.18 $\mu\text{m}/\text{pixel}$ Exposure times 100 milli sec-2 sec 	
Additional Specifications		
Image Format	Save image as a tiff (preferred) or jpeg	
Computer	Computer with sufficient power to handle large images (0.5–5 GB)	
Software	Image stitching software (microscope's imaging software or equivalent, like ImageJ)	

Additional Kits, Reagents & Equipment

The items in the table below are validated by 10x Genomics and are highly recommended for the Visium Spatial Reagent Kits protocols. **Substituting materials may adversely affect system performance.** This list does not include standard laboratory equipment such as water baths, centrifuges, vortex mixers, pH meters, freezers etc. For some items, a number of options are listed. Choose item based on availability and preference.

For information on tested glass slides, refer to product-specific documentation.

Item	Description	Supplier	Part Number (US)
Plastics			
1.5 ml tubes	DNA LoBind Tubes, 1.5 ml	Eppendorf	022431021
	Low DNA Binding Tubes, 1.5 ml	Sarstedt	72.706.700
2.0 ml tubes (when processing more than 2 slides)	DNA LoBind Tubes, 2.0 ml	Eppendorf	022431048
	Low DNA Binding Tubes, 2.0 ml	Sarstedt	72.695.700
15 ml tubes	15 ml PP Centrifuge Tubes	Corning	430791
50 ml tubes	Self-Standing Polypropylene Centrifuge Tubes (50 ml), sterile	Corning	430921
0.2 ml PCR 8-tube strips	PCR Tubes 0.2 ml 8-tube strips	Eppendorf	951010022
<i>Choose either Eppendorf, USA Scientific, or Thermo Fisher Scientific PCR 8-tube strips</i>	TempAssure PCR 8-tube strip	USA Scientific	1402-4700
	MicroAmp 8-Tube Strip, 0.2 ml (see Tips & Best Practices for more information)	Thermo Fisher Scientific	N8010580
	MicroAmp 8 -Cap Strip, clear (see Tips & Best Practices for more information)	Thermo Fisher Scientific	N8010535
Slide mailer/tube	Simport Scientific LockMailer Tamper Evidence Slide Mailer (alternatively, use a 50-ml centrifuge tube)	Thermo Fisher Scientific	22-038-399
	Self-Standing Polypropylene Centrifuge Tubes (50 ml), sterile	Corning	430921
PCR plates and sealing film	Hard-shell PCR Plates 96-well, thin wall (pkg of 50) (Or any compatible PCR Plate)	Bio-Rad	HSP9665
	Microseal 'B' PCR Plate Sealing Film, adhesive (Or any compatible PCR Plate sealing adhesive)	Bio-Rad	MSB1001
Pipette tips	Tips LTS 200UL Filter RT-L200FLR	Rainin	30389240
	Tips LTS 1ML Filter RT-L1000FLR	Rainin	30389213
	Tips LTS 20UL Filter RT-L20FLR	Rainin	30389226

Item	Description	Supplier	Part Number (US)
Wide Bore Pipette tips	Tips RT LTS 200UL FLW	Rainin	30389241
	Tips RT LTS 1000UL FLW	Rainin	30389218
Reagent Reservoirs	Divided Polystyrene Reservoirs	VWR	41428-958
Kits & Reagents			
Nuclease-free Water (not DEPC treated)	Nuclease-free Water	Thermo Fisher Scientific	AM9937
Tris 1M	Tris 1M, pH 8.0, RNase-free	Thermo Fisher Scientific	AM9855G
	Tris 1M, pH 8.0	TEKONOVA	T5080
	UltraPure 1M Tris-HCl, pH 8.0	Invitrogen	15568025
10X PBS	PBS - Phosphate Buffered Saline (10X) pH 7.4, RNase-free	Thermo Fisher Scientific	AM9624
Tween 20	Tween 20 Surfact-Amps Detergent Solution (10% solution)	Thermo Fisher Scientific	28320
qPCR Mix	KAPA SYBR FAST qPCR Master Mix (2X)	KAPA Biosystems (US Only)	KK4600
		Millipore Sigma (Europe, Asia, & Canada)	
SPRIselect Reagent	SPRIselect Reagent Kit	Beckman Coulter	B23318
Ethanol	Ethyl alcohol, Pure (200 Proof, anhydrous)	Millipore Sigma	E7023-500ML
8M KOH	Potassium Hydroxide Solution, 8M	Millipore Sigma	P4494-50ML
20X SSC Buffer	SSC Buffer 20X Concentrate	Millipore Sigma	S66391L
Buffer EB	Qiagen Buffer EB	Qiagen	19086
Eosin	Eosin Y solution, alcoholic	Millipore Sigma	HT110116
	Eosin Y Solution (Modified Alcoholic)	Abcam	ab246824
	Eosin Y Solution, Alcoholic, with Phloxine	Millipore Sigma	HT110332
	Eosin Y with Phloxine 1% alcoholic solution	VWR	10143
Ultrapure Water	Ultrapure/Milli-Q water (from Milli-Q Integral Ultrapure Water System or equivalent)		
Equipment			
Pipettes	Pipet-Lite Multi Pipette L8-200XLS+	Rainin	17013805
	Pipet-Lite LTS Pipette L-2XLS+	Rainin	17014393
	Pipet-Lite LTS Pipette L-10XLS+	Rainin	17014388
	Pipet-Lite LTS Pipette L-20XLS+	Rainin	17014392
	Pipet-Lite LTS Pipette L-100XLS+	Rainin	17014384
	Pipet-Lite LTS Pipette L-200XLS+	Rainin	17014391
	Pipet-Lite LTS Pipette L-	Rainin	17014382

Item	Description	Supplier	Part Number (US)
	1000XLS+		
Mini Centrifuge	VWR Mini Centrifuge (or any equivalent mini centrifuge)	VWR	76269-064
Quantification & Quality Control			
<i>Choose Bioanalyzer, TapeStation, or LabChip based on availability & preference.</i>			
Bioanalyzer & associated reagents	2100 Bioanalyzer Laptop Bundle (discontinued)	Agilent	G2943CA
	Replacement 2100 Bioanalyzer Instrument/2100 Expert Laptop Bundle	Agilent	G2939BA/G2953CA
	High Sensitivity DNA Kit	Agilent	5067-4626
TapeStation & associated reagents	4200 TapeStation	Agilent	G2991AA
	High Sensitivity D1000 ScreenTape/Reagents	Agilent	5067-5584/ 5067-5585
	High Sensitivity D5000 ScreenTape/Reagents	Agilent	5067-5592/ 5067-5593
LabChip & associated reagents	LabChip GX Touch HT Nucleic Acid Analyzer	PerkinElmer	CLS137031
	DNA High Sensitivity Reagent Kit	PerkinElmer	CLS760672
Qubit & associated reagents (for determining dilution factor for TapeStation or Bioanalyzer)	Qubit Fluorometer	ThermoFisher Scientific	Q33238
	Qubit Assay Tubes	ThermoFisher Scientific	Q32856
	Qubit dsDNA HS and BR Assay Kits	ThermoFisher Scientific	Q32854
Library Quantification Kit	KAPA Library Quantification Kit for Illumina Platforms	KAPA Biosystems	KK4824

Workflow Overview

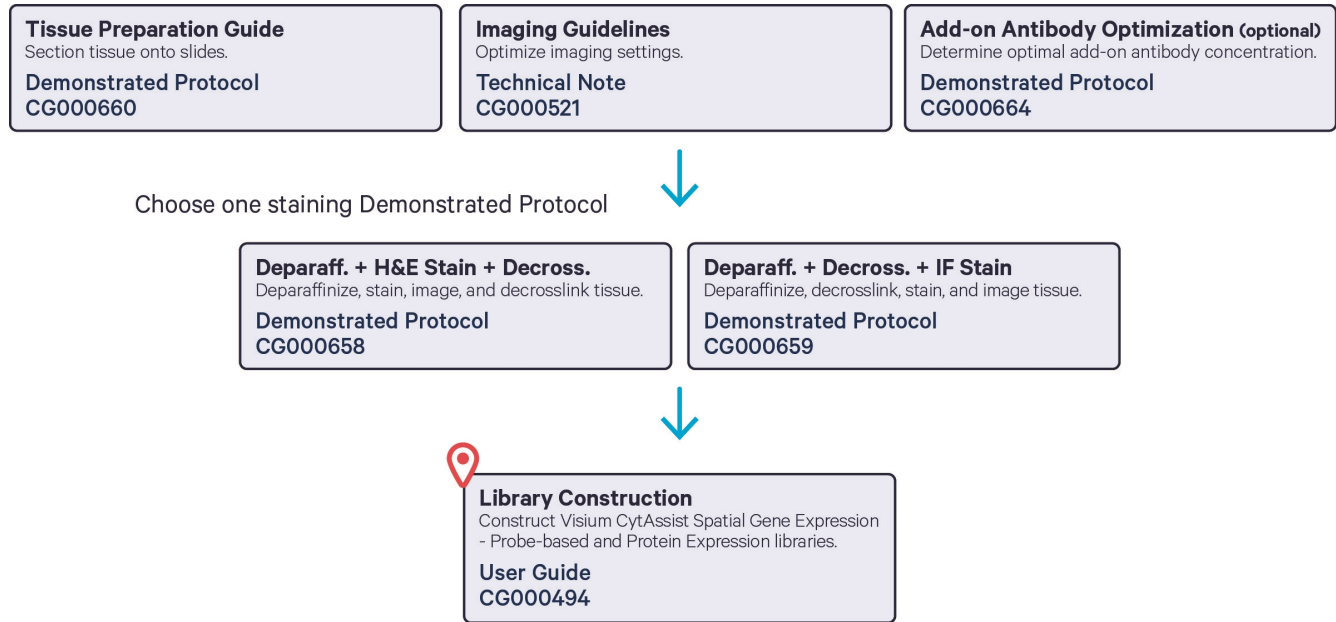

Protocol Steps & Timing

Steps	Timing	Stop & Store
Day 1		
Step 1: DNase Treatment (page 60)		
1.1 DNase Treatment (page 62)	45 min	
Step 2: Probe Hybridization (page 64)		
2.1 Probe Hybridization (page 66)	Overnight	
Day 2		
Step 3: Probe Ligation (page 70)		
3.1 Post-Hybridization Wash (page 72)	18 min	
3.2 Probe Ligation (page 74)	60 min	
3.3 Post-Ligation Wash (page 76)	12 min	 4°C ≤24 h
Step 4: Protein Labeling (page 78)		
4.1 Tissue Blocking (page 80)	60 min	
4.2 Antibody Incubation (page 81)	Overnight	
Day 3		
4.3 Post-Antibody Incubation Wash (page 83)	25 min	
Step 5: CytAssist Enabled Probe Release & Extension (page 85)		
5.1 CytAssist-Enabled RNA Digestion & Tissue Removal (page 88)	40 min	
5.2 Probe & Antibody Tag Extension (page 98)	20 min	 4°C ≤2 h
5.3 Probe & Antibody Tag Elution (page 99)	15 min	
Step 6: Pre-Amplification and SPRIselect (page 101)		
6.1 Pre-Amplification (page 103)	40 min	
6.2 Pre-Amplification Cleanup - SPRIselect (page 105)	30 min	 4°C ≤72 h or -20°C ≤4 weeks
6.3 Cycle Number Determination – qPCR (page 106)	45 min	
Step 7: Visium CytAssist Spatial Gene Expression – Probe-based Library Construction (page 109)		
7.1 GEX Sample Index PCR (page 111)	40 min	
7.2 GEX Post-Sample Index PCR Cleanup – SPRIselect (page 113)	30 min	 -20°C long-term

Steps	Timing	Stop & Store
7.3 GEX Post-Library Construction QC (page 114)	50 min	
Step 8: Visium CytAssist Spatial Protein Expression Library Construction (page 115)		
8.1 Protein Sample Index PCR (page 117)	40 min	
8.2 Protein Post-Sample Index PCR Cleanup – SPRIselect (page 119)	30 min	 -20°C long-term
8.3 Protein Post-Library Construction QC (page 120)	50 min	

Stepwise Objectives

The Visium CytAssist Spatial Gene and Protein Expression assay is designed to analyze mRNA and protein in human tissue sections derived from formalin fixed & paraffin embedded (FFPE) tissue samples. It uses a combination of oligo-tagged antibodies and probes targeting the whole transcriptome. Each Visium CytAssist Spatial Gene Expression Slide v2 contains Capture Areas with barcoded spots that include oligonucleotides required to capture both gene expression probes and antibody tags. Before the assay, tissue sections are processed as described in their relevant Demonstrated Protocol. See [Workflow Overview on page 20](#) for documentation references.

Human whole transcriptome probe panels, consisting of ~3 pairs of specific probes for each targeted gene are added to the tissue, enabling hybridization and ligation of each probe pair. Next, the tissue is incubated with an oligo-tagged antibody panel. Tissue slides and Visium CytAssist Spatial Gene Expression v2 Slides are loaded into the Visium CytAssist instrument, where they are brought into proximity with one another. Both gene expression probes and antibody tags are released from the tissue upon CytAssist Enabled RNA Digestion & Tissue Removal, enabling capture by the spatially barcoded oligonucleotides present on the Visium slide surface. The Visium CytAssist Spatial Gene Expression v2 Slide is removed from the Visium CytAssist for downstream library preparation. Paired gene expression and protein libraries are generated from each tissue section and sequenced. Spatial Barcodes are used to associate the reads back to the tissue section images for spatial mapping of gene and protein expression.

This document outlines the protocol for generating Visium CytAssist Spatial Gene Expression - Probe-based libraries and Visium CytAssist Spatial Protein Expression libraries. This workflow is only supported for human tissues.

Visium CytAssist Spatial Gene Expression Slides

Visium CytAssist Spatial Gene Expression Slide v2, 6.5 mm

The CytAssist Spatial Gene Expression Slide v2, 6.5 mm has 2 Capture Areas. Each Capture Area is 6.5 x 6.5 mm and defined by a fiducial frame (fiducial frame + Capture Area is 8 x 8 mm). The Capture Area has ~5,000 barcoded spots. Each spot has the following oligos:

- Gene Expression: Illumina TruSeq partial read 1 sequencing primer, 16 nucleotide (nt) Spatial Barcode, 12 nt unique molecular identifier (UMI), 30 nt poly(dT) sequence (captures ligation product).
- Protein Detection: Illumina Nextera Read 1 (partial read 1 sequencing primer), 16 nt Spatial Barcode, 12 nt Unique molecular identifier (UMI), 16 nt partial capture sequence (captures antibody tags).
- Both gene expression and protein detection oligos within the same spot share the same Spatial Barcode.
- Each Capture Area on the CytAssist Spatial Gene Expression Slide is surrounded by a spacer. This spacer creates a reaction chamber that facilitates proper reagent addition and creates a seal between the CytAssist Spatial Gene Expression Slide and the tissue slide.
- The active surface of the slide is defined by a readable label that includes the serial number.

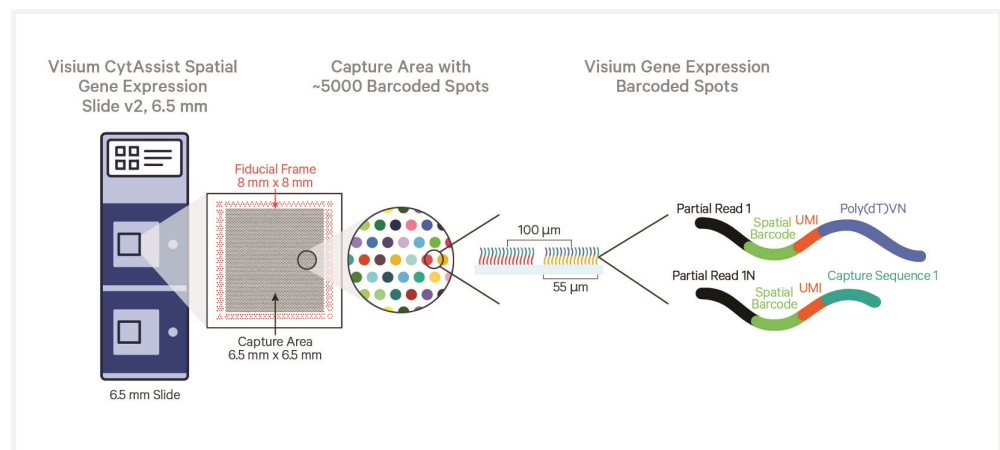

Visium CytAssist Spatial Gene Expression Slide v2, 11 mm

The CytAssist Spatial Gene Expression Slide v2, 11 mm has 2 Capture Areas. Each Capture Area is 11 x 11 mm and defined by a fiducial frame (fiducial frame + Capture Area is 12.5 x 12.5 mm). The Capture Area has ~14,000 barcoded spots. Each spot has the following oligos:

- Gene Expression: Illumina TruSeq partial read 1 sequencing primer, 16 nt Spatial Barcode, 12 nt unique molecular identifier (UMI), 30 nt poly(dT) sequence (captures ligation product).
- Protein Detection: Illumina Nextera Read 1 (partial read 1 sequencing primer), 16 nt Spatial Barcode, 12 nt unique molecular identifier (UMI), 16 nt partial capture sequence (captures antibody tags).
- Both gene expression and protein detection oligos within the same spot share the same Spatial Barcode.
- Each Capture Area on the CytAssist Spatial Gene Expression Slide is surrounded by a spacer. This spacer creates a reaction chamber that facilitates proper reagent addition and creates a seal between the CytAssist Spatial Gene Expression Slide and the tissue slide.
- The active surface of the slide is defined by a readable label that includes the serial number.

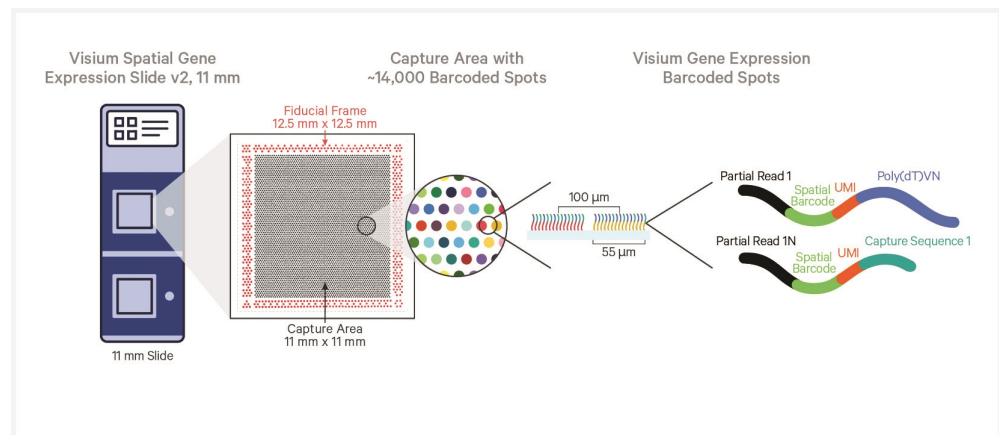

Step 1: DNase Treatment

Deparaffinized, stained, and decrosslinked tissues in a Visium CytAssist Tissue Slide Cassette are treated with DNase to reduce the likelihood of signal from genomic DNA.

Step 2: Probe Hybridization

The human whole transcriptome probe panel, consisting of ~3 specific probes for each targeted gene respectively, is added to the deparaffinized, destained, and decrosslinked tissues. Together, probe pairs hybridize to their complementary target RNA.

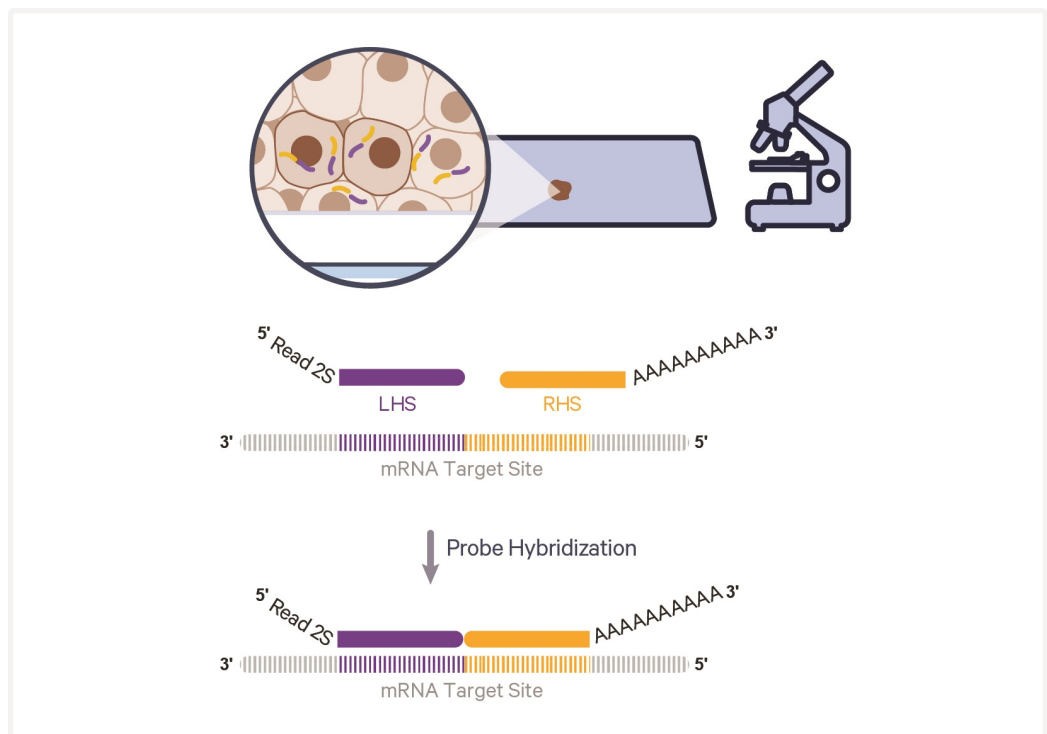

Step 3: Probe Ligation

After hybridization, a ligase is added to bridge the junction between the probe pairs that have hybridized to RNA, forming a ligation product.

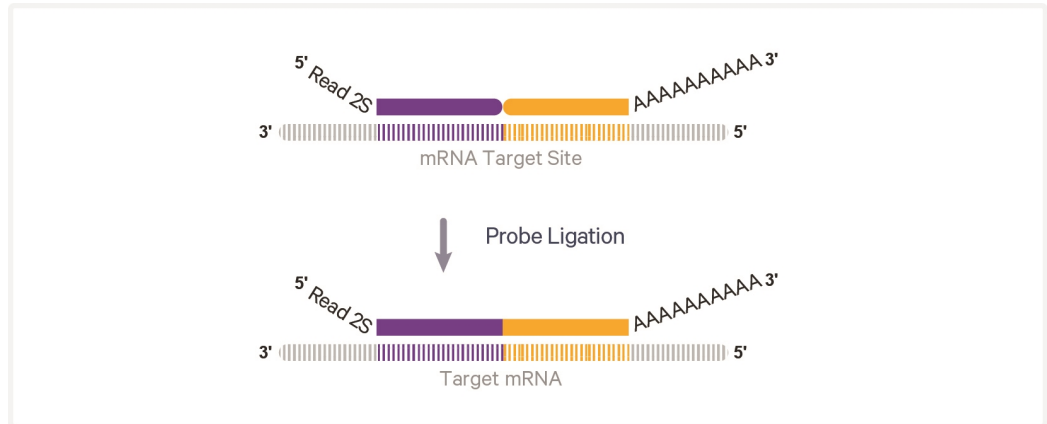

Step 4: Protein Labeling

After ligation, the tissue is blocked with Blocking Reagent to minimize nonspecific binding of the antibodies to regions with no target protein expression. After blocking, the tissue is incubated with a mixture of antibodies.

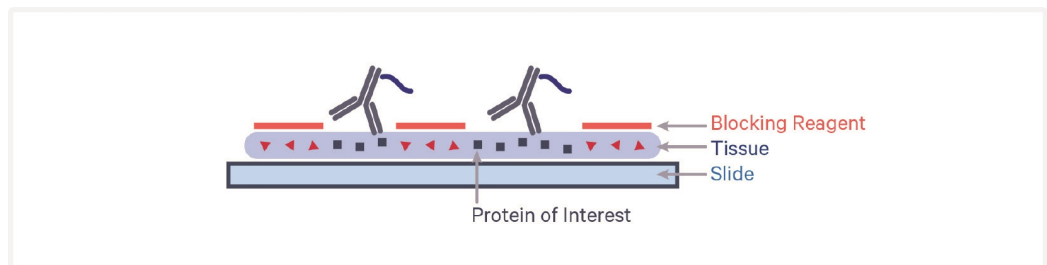

Step 5: Probe and Antibody Tag Release & Extension

Probe release and capture occurs in the Visium CytAssist instrument. The single stranded ligation products and antibody tags are released from the tissue upon RNase treatment and tissue removal, and then captured on the Visium slide. Once ligation products and antibody tags are captured, the slides can be removed from the instrument.

Ligation products and antibody tags are extended by the addition of the UMI, Spatial Barcode, and partial Read 1 primer. This generates spatially-barcoded ligation products and antibody tags, which can then be carried forward for library preparation.

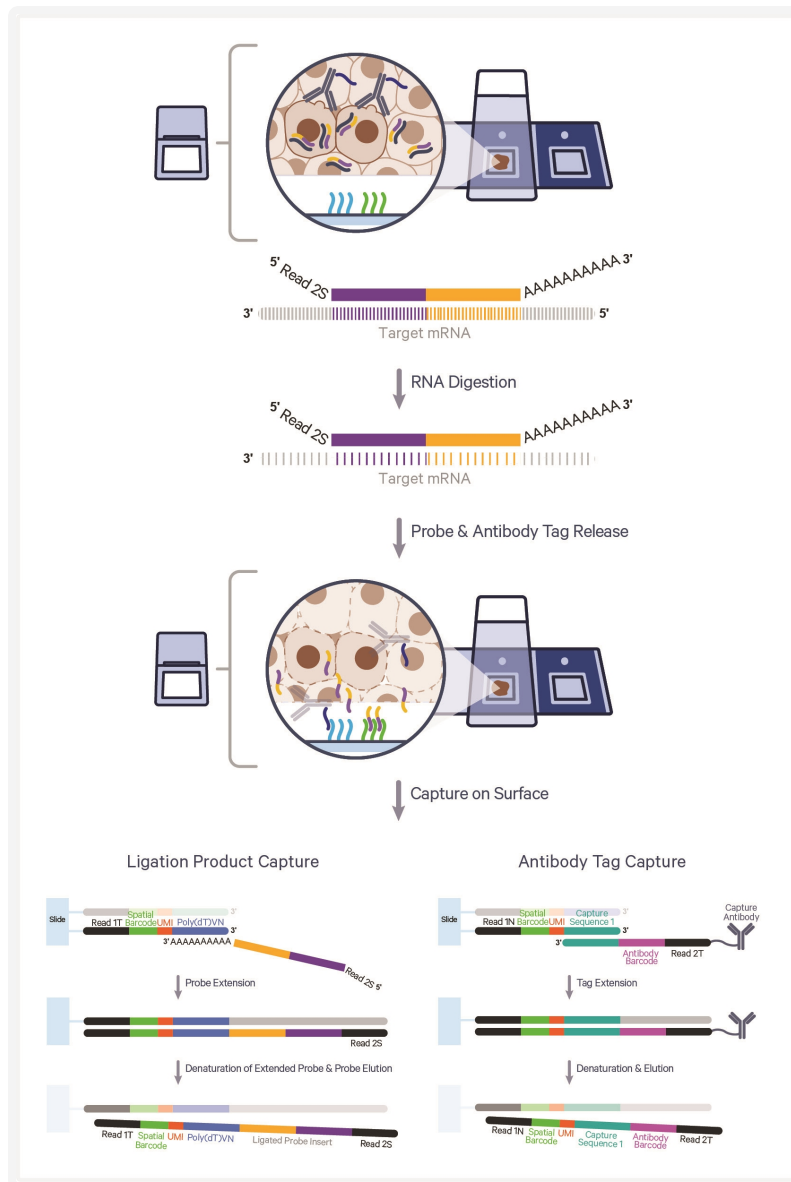

Step 6: Pre-amplification and SPRIselect

To generate ample material for library construction, barcoded ligation and antibody tag products are amplified. This pre-amplification is followed by SPRIselect cleanup.

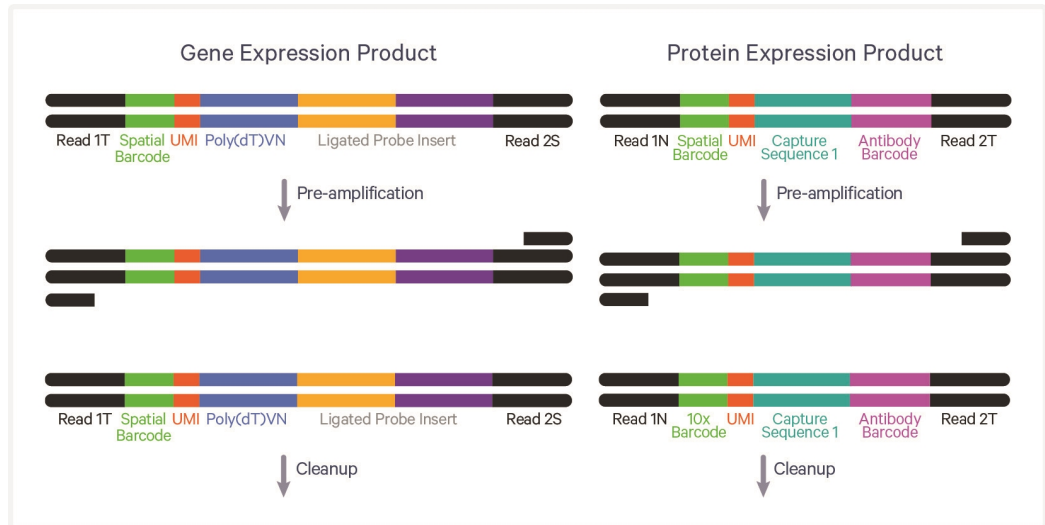

Step 7: Visium CytAssist Spatial Gene Expression - Probe-based Library Construction

Pre-amplification material is collected for qPCR to determine sample index PCR cycle number for gene expression libraries. The amplified material then undergoes indexing via sample index PCR to generate final library molecules. The final libraries are cleaned up by SPRIselect, assessed on a Bioanalyzer or a similar instrument, quantified by qPCR, and then sequenced.

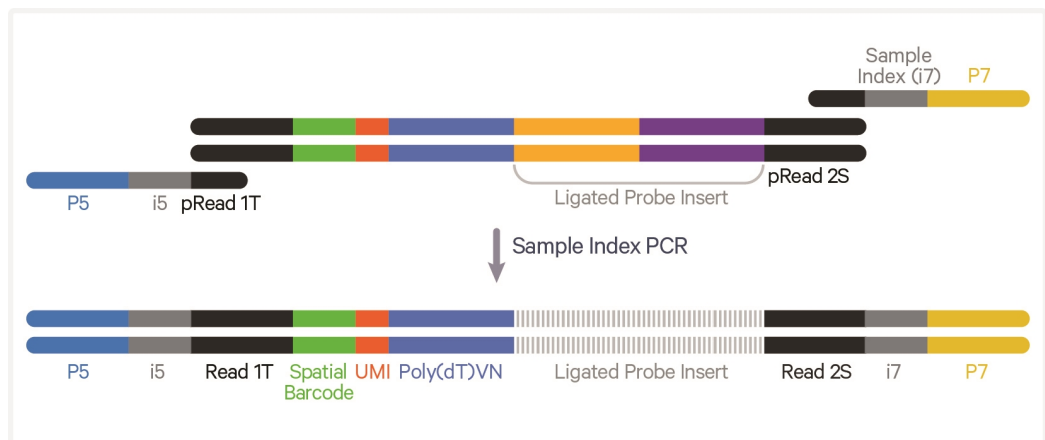

Step 8: Visium CytAssist Spatial Protein Expression Library Construction

Pre-amplification material is collected for qPCR to determine Sample Index PCR number for protein libraries. The amplified material then undergoes indexing via Sample Index PCR, which generates paired library molecules. These molecules are cleaned up by SPRIselect, assessed on a bioanalyzer or a similar instrument, quantified, and then sequenced.

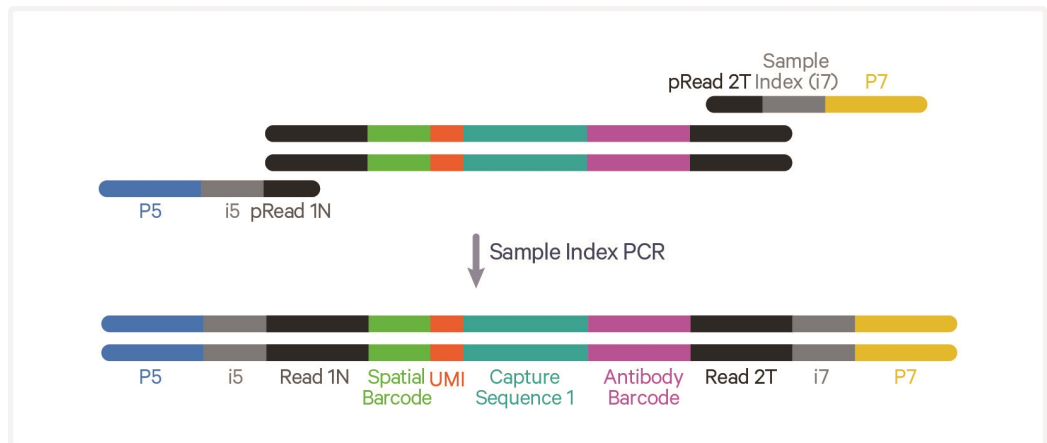

Sequencing

A Visium CytAssist Spatial Gene Expression - Probe-based library comprises standard Illumina paired-end constructs, which begin and end with P5 and P7 adaptors. The 16 bp Spatial Barcode and 12 bp UMI are encoded in TruSeq Read 1, while Small RNA Read 2 (Read 2S) is used to sequence the ligated probe insert.

A Visium CytAssist Spatial Protein Expression library comprises standard Illumina paired-end constructs, which begin and end with P5 and P7. The 16 bp Spatial Barcode and 12 bp UMI are encoded in Nextera Read 1, while TruSeq RNA Read 2 (Read 2) is used to sequence the antibody tag.

Illumina sequencer compatibility, sample indices, and library loading information are summarized in the Sequencing section.

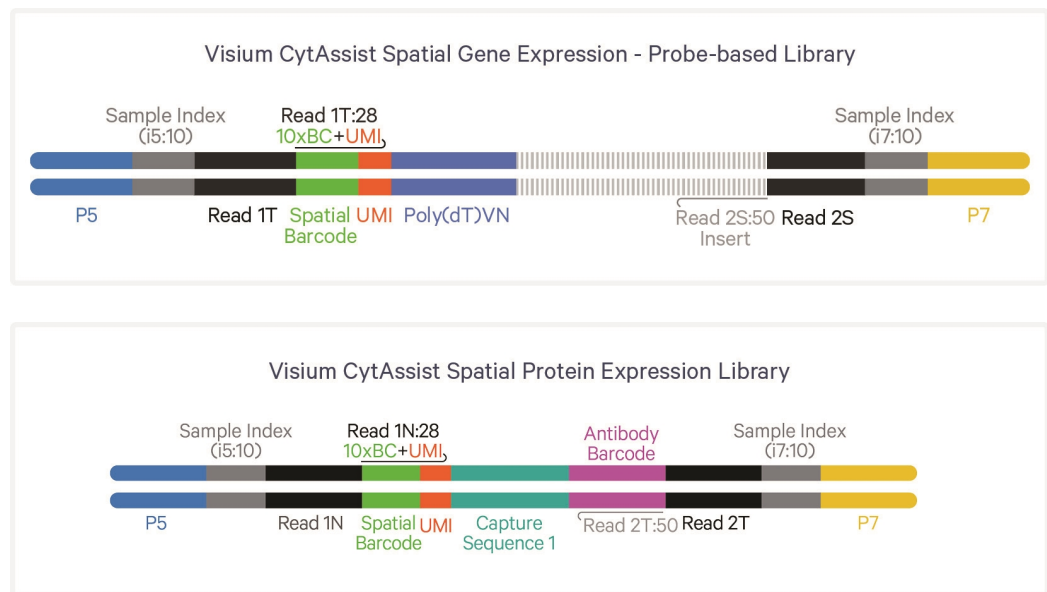

See [Oligonucleotide Sequences on page 148](#)

Tips & Best Practices

Icons



Tips & Best Practices section includes additional guidance



Signifies critical step requiring accurate execution



Troubleshooting section includes additional guidance



Indicates a version specific update in volume, temperature, instruction, etc.

General Reagent Handling

- Fully thaw and thoroughly mix reagents before use.
- When pipette mixing reagents, unless otherwise specified, set pipette to 75% of total volume.
- Change gloves frequently to avoid contamination of samples or reagents with DNase.

Visium Slide Storage

- Do not open the mylar bag containing the Visium Spatial slides until slides are ready to be used.

Pipette Calibration

- Follow manufacturer's calibration and maintenance schedules.
- Pipette accuracy is particularly important when using SPRIselect reagents.

Visium Spatial Slide Handling

- Always wear gloves when handling slides.
- Ensure that the active surface of a slide faces up and is never touched. The active surface is defined by a readable label.
- Minimize exposure of the slides to sources of particles and fibers.
- When pipetting reagent onto a slide, avoid generating bubbles.
-  Time between adding the final reagent to the Probe and Antibody Tag Release Mix and loading the complete Probe and Antibody Tag Release Mix onto spacers on the Visium CytAssist Spatial Gene Expression v2 Slide on the Visium CytAssist instrument and starting a run should not exceed

5 min. Start the run immediately after reagent addition.

Tissue Slide Handling

- To ensure compatibility with the Visium CytAssist, tissue sections must be placed in specific areas on a blank slide. Tested slides, as well as appropriate tissue placement areas, are listed in the [CytAssist Validated Slides](#) section.

Visium CytAssist Tissue Slide Cassette

- The Visium CytAssist Tissue Slide Cassette is used to create wells on tissue slides for reagent addition and removal. It is distinct from the Visium Cassette, which is used to encase Visium CytAssist Spatial Gene Expression Slides.
- The Visium CytAssist Tissue Slide Cassette is a single use item.
- Gaskets are used to create a sealed well around tissue. Gaskets are combined with the complimentary Visium CytAssist Tissue Slide Cassette components to create a complete Visium CytAssist Cassette.
- The appropriately sized Visium CytAssist Tissue Slide Cassette and Gasket will be provided with the Visium CytAssist Spatial Gene Expression Slide kits.
- Reagent volumes for 6.5 mm cassettes and 11 mm cassettes will be differentiated by ■ and ▲ symbols respectively.
- Before assembling the Visium CytAssist Tissue Slide Cassette, determine the correct slide orientation with the Tissue Slide Loading Guide (CG000548)
- To ensure that the gasket surrounds the tissue area of interest, gaskets can be adjusted from top to bottom (see image below). 6.5 mm gaskets may also be adjusted from side to side.
- Tissue or area of interest should be centered within the gasket.
- Before assembly, inspect the moveable gasket to ensure that the gasket perimeter and corners are free of excess silicone. Excess silicone should be safely removed with forceps or a pipette tip.
- Assemble against a white background for easy tissue visualization during alignment.

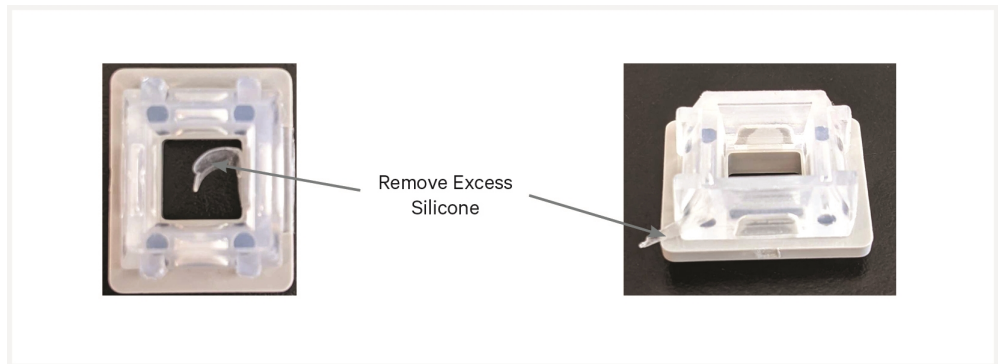
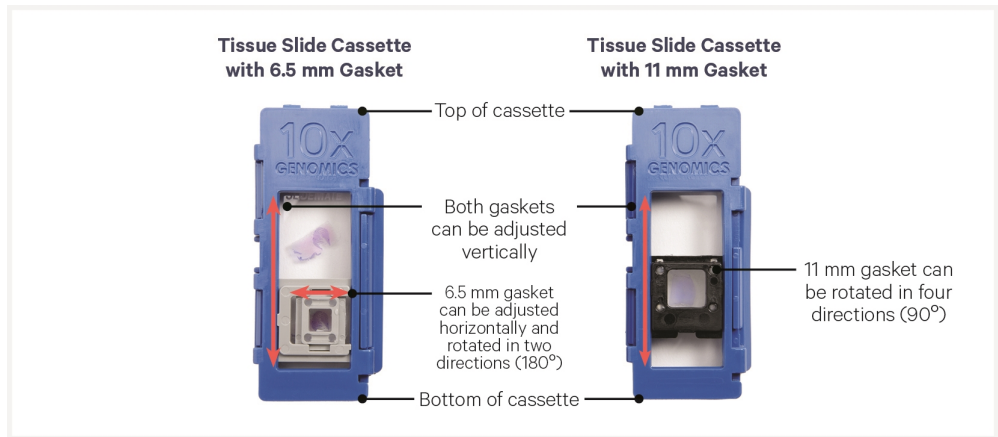

Visium CytAssist Tissue Slide Cassette Assembly

Assembly instructions apply to both Tissue Slide Cassette sizes.



Wear fresh gloves while assembling Tissue Slide Cassette



Exercise caution when handling slide edges to prevent injury.

Break cassette into two halves by bending each half at the hinge until they snap apart



Place tissue slide into lower half of cassette with tissue facing up



The 6.5 mm gasket can be adjusted horizontally and rotated in two directions (180°) while 11 mm gasket can be rotated in four directions (90°). Determine the appropriate configuration that allows the gasket to encompass the tissue region of interest.

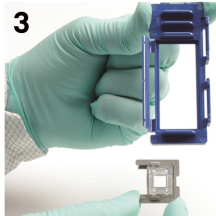

Gently place top half of cassette over bottom half. DO NOT assemble together until Step 6.

Securely combine gasket with top half of cassette until the gasket snaps into place.

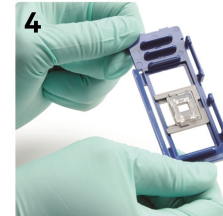

Adjust gasket such that gasket is over the tissue region of interest. The 6.5 mm gasket can be adjusted horizontally as well as vertically.

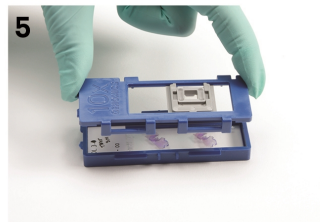

Apply even pressure on top of cassette until it clicks shut. Verify that clip is completely secured over hinges.

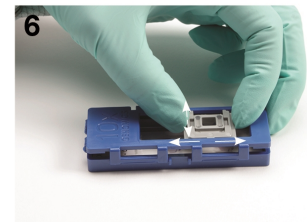

Turn cassette over and verify tissue region of interest is within gasket. DO NOT move gasket once cassette is closed. If necessary, open cassette and recenter gasket.

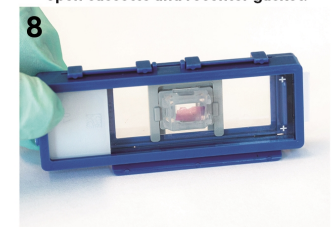
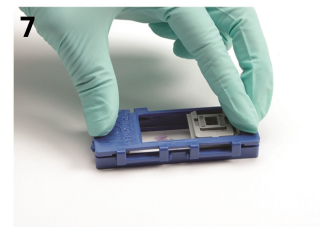

Visium CytAssist Tissue Slide Cassette Removal

Removal instructions apply to both Tissue Slide Cassette sizes.

Pull clip up to detach upper and lower halves of cassette

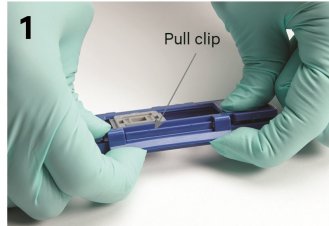

Open cassette by continuing to lift clip upward. If slide sticks to gasket, continue to apply even upward pressure to separate slide from gasket



Hold slide by the label and lift slide out from lower half



Slides in images are representative.

Visium Cassette

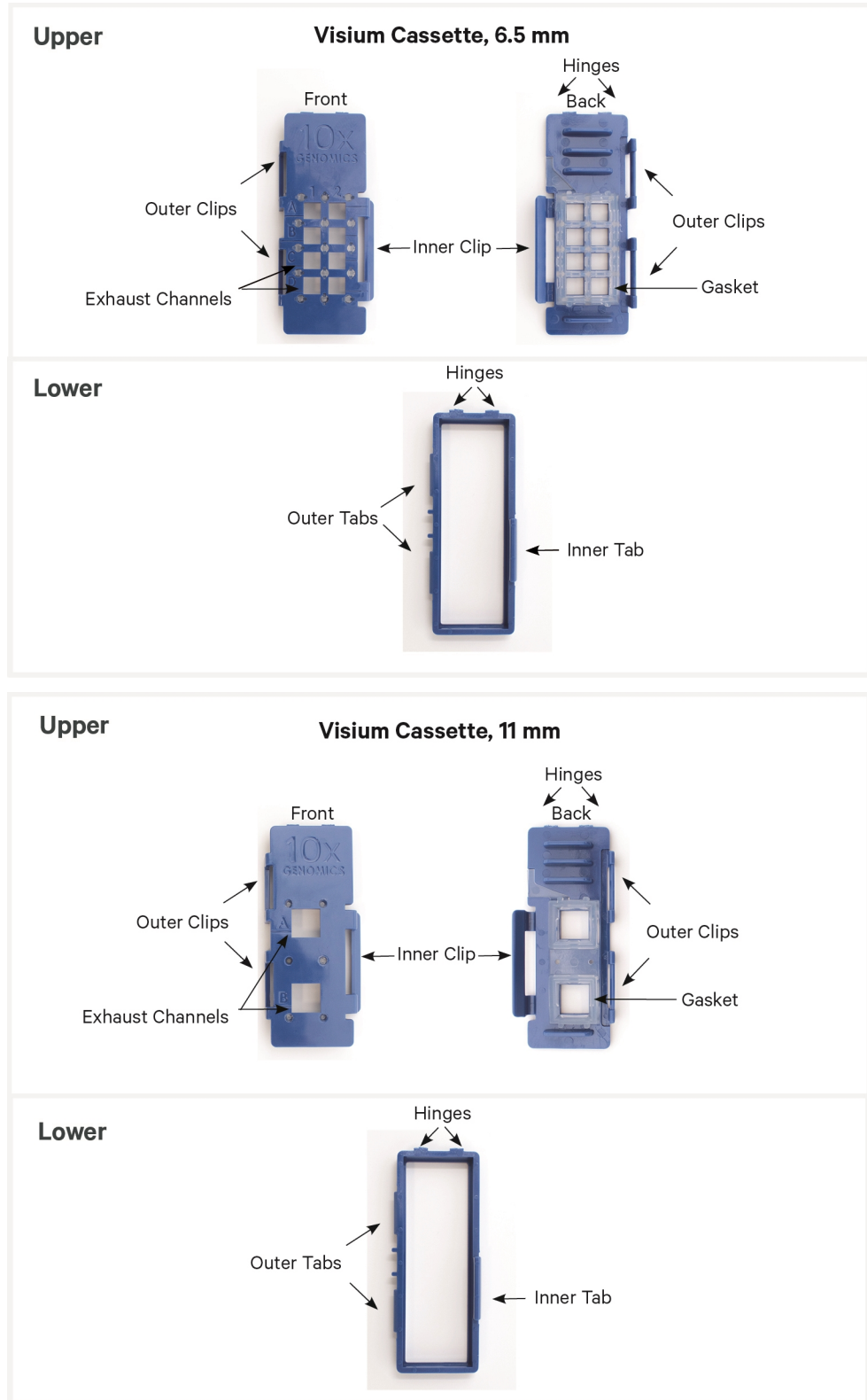

- The Visium Cassette encases the slide and creates leakproof wells for reagent addition.
- The Visium Cassette is a single use item.
- If using a Visium CytAssist 6.5 mm Slide, only wells A1 and D1 of the Visium Cassette are used. If necessary, circle A and D on the cassette with a permanent marker to serve as a reminder.
- Ensure that the Visium Cassette and gasket are free of debris before assembly. If placing the top half of the cassette on a surface, ensure the gasket faces away from the surface so it does not collect debris.



- If the exhaust channels have raised pieces of silicone, these pieces are considered excess and must be removed. Run a 10 μ l pipette tip through the exhaust channels to ensure they are clear. If excess silicone remains, remove with tweezers or a pipette tip.
- Failure to remove excess silicone may prevent adequate venting of the cassette during heated incubation steps.
- Visually inspect the gasket to ensure it is seated properly.
- If the gasket appears warped, the Visium Cassette is still safe to use as long as the cassette can fully close.

Remove Excess Silicone

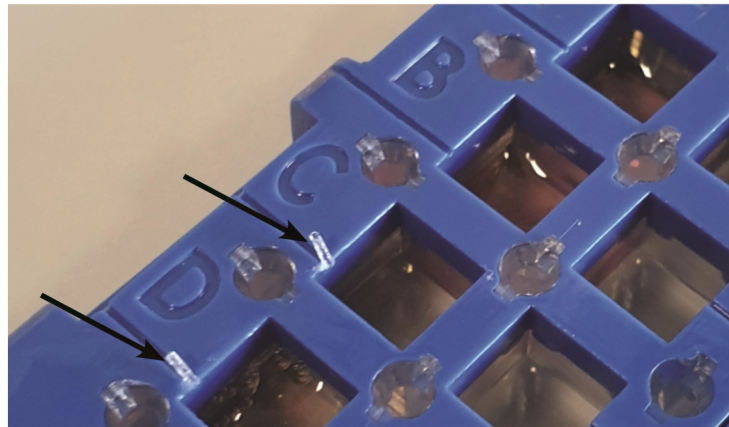

- See Visium Cassette Assembly & Removal instructions for details on assembly and removal.
- Practice assembly with a blank slide (75 x 25 x 1 mm).
- Place the slides in the Visium Cassette only when specified.
- Applying excessive force to the slide may cause the slide to break.

Visium Cassette Assembly

Ensure that the surface of the cassette is dry. Cassette may also be assembled in the hand for comfort.



DO NOT fold over upper and lower halves of cassette before detaching hinges.

Break cassette into two halves by bending each half at the hinge until they snap apart

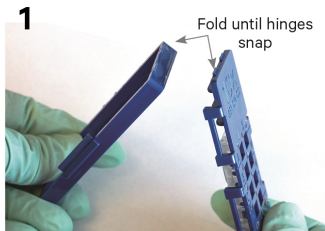

Place upper and lower halves of cassette, and Visium slide, directed upward on bench

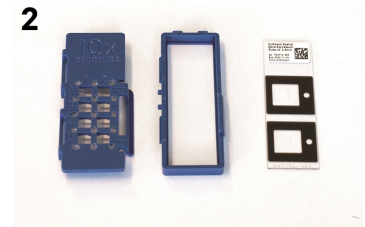

Place Visium slide with active surface facing upwards into lower half of cassette; ensure label is toward hinges



Press slide down into grooves of the bottom half of the cassette until it sits firmly in place

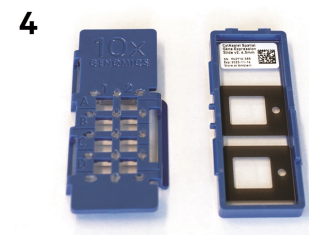

Secure outer clips of top half with outer tab of bottom half

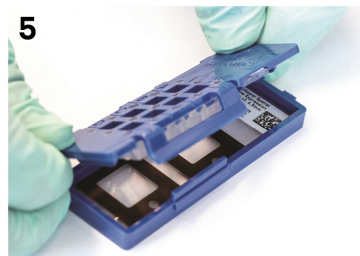

Press firmly on top of cassette until it clicks shut

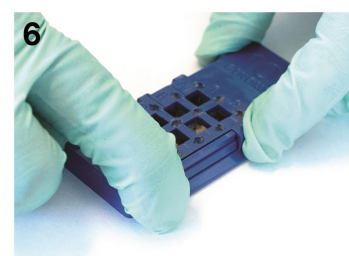

Exercise caution when handling slide edges to prevent injury.

Slides in images are representative.

Visium Cassette Removal



Assembly and removal steps apply to both 6.5 and 11 mm Cassettes.

Pull inner clip up from inner tab to detach upper and lower halves of cassette

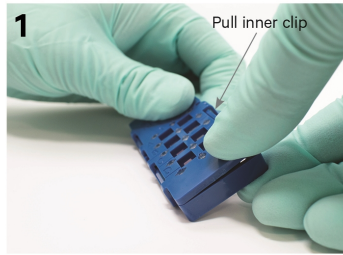

Open cassette by continuing to lift upper half upward

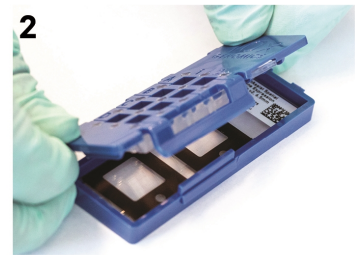

Lift slide out from lower half



Slides in images are representative.

Reagent Addition to & Removal from Wells

Reagent Addition

- Assemble slide into the cassette flat on a clean work surface.
- Dispense and remove reagents along the side of the wells without touching the slide surface, tissue sections (when applicable), and without introducing bubbles.
- If applicable, perform washes next to the thermal cycler to avoid significant changes in temperature during washes.



- Always cover the Capture Area or tissue completely when adding reagents to the well. A gentle tap may help spread the reagent more evenly.

Reagent Addition/Removal

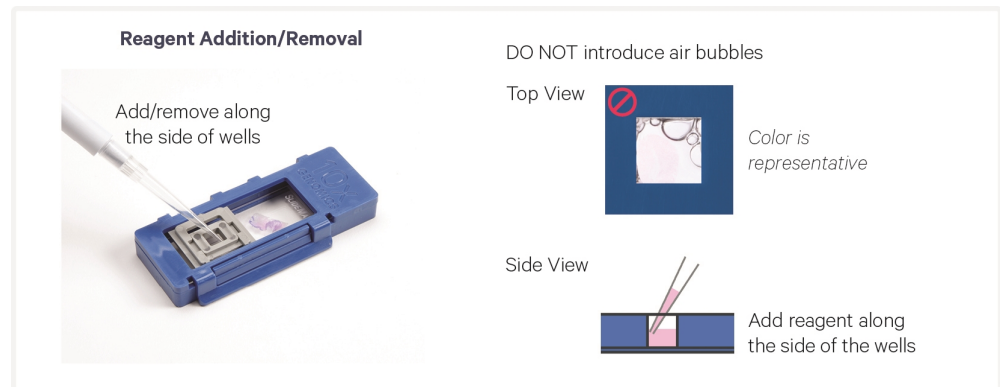

Reagent Removal from Wells

- Slightly tilt the cassette while removing the reagent.
- Place the pipette tip on the bottom edge of the wells.
- Remove reagents along the side of the wells without touching the tissue sections (when applicable) and without introducing bubbles.
- Remove all liquid from the wells in each step. To ensure complete removal, check the bottom of the well by tilting the cassette slightly. A meniscus at the bottom of the well will indicate the presence of liquid in

the well. Repeat removal steps until no reagent remains.

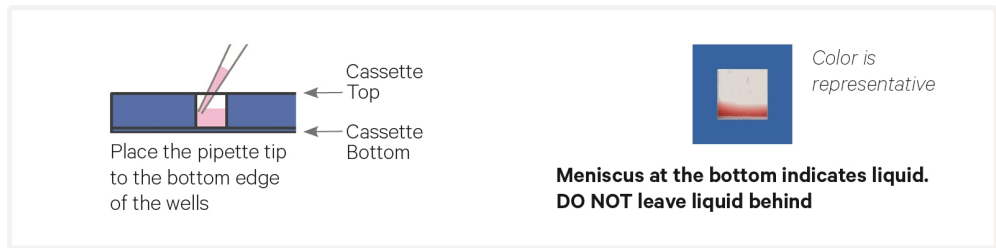

Visium Slide Seal Application & Removal

Application

- If applying a Visium Slide Seal to a Tissue Slide Cassette, the seal must be cut in half lengthwise. Cut the seal as shown in the image below. Three pre-cut seals are necessary for this assay.

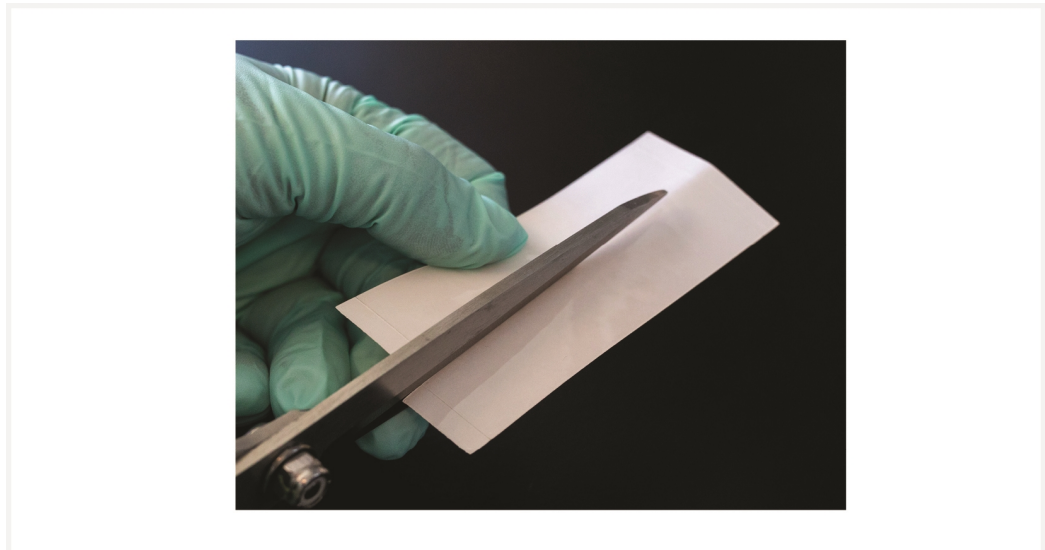

- Place the cassette flat on a clean work surface. Ensure surface of cassette is dry.
- Remove the back of the adhesive Visium Slide Seal.
- Align the Visium Slide Seal with the surface of the cassette and apply while firmly holding the cassette with one hand.
- Press on the Visium Slide Seal to ensure uniform adhesion.
- Use a fresh Visium Slide Seal when prompted during the protocol. Steps that do not require a new slide seal will specify that the slide seal should be pulled back and reapplied instead.

Apply Visium Slide Seal

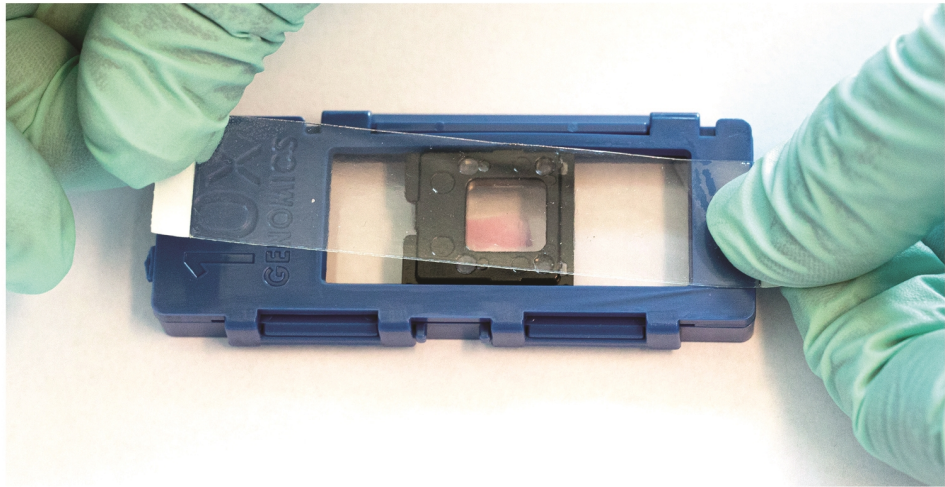

Removal

- Place the cassette flat on a clean work surface.
- Grasp a Visium Slide Seal corner. Carefully pull on the Visium Slide Seal up and across the cassette while firmly holding the cassette. Ensure that no liquid splashes out of the wells. Movement of the gasket during slide seal removal could damage the tissue section.

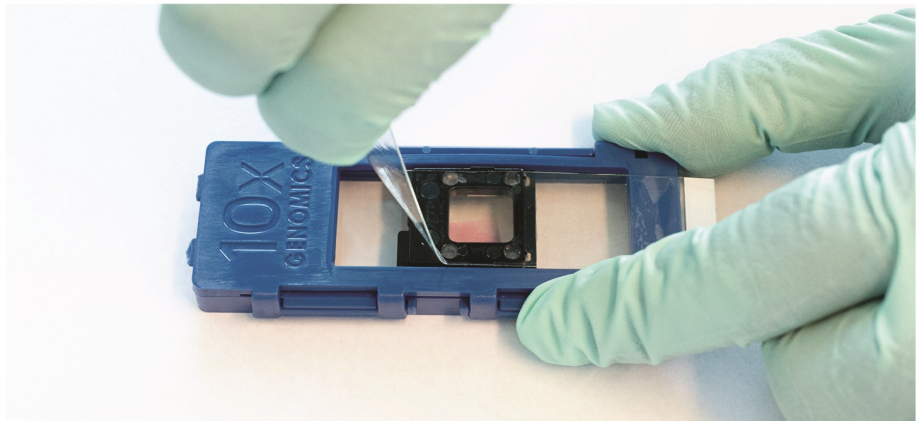

Slide Incubation Guidance

Incubation at a Specified Temperature

- Position a Low Profile Thermocycler Adapter on a thermal cycler that is set at the incubation temperature.
- Ensure that the Low Profile Thermocycler Adapter is in contact with the thermal cycler block surface uniformly. Pre-equilibrate adapters at the HOLD temperature described in the protocol steps for at least five minutes.
- When incubating a slide encased in a cassette, place the assembled unit on the Low Profile Thermocycler Adapter with the wells facing up. Ensure the cassette is in complete contact with the adapter. The cassette should always be sealed when on the Low Profile Thermocycler Adapter. The cassette should snap into place when seated properly on the Low Profile Thermocycler Adapter.

Incubate Assembled Visium Cassette

- Open and close the thermal cycler lid gently. If the lid is adjustable, tighten lid only as much as necessary. Avoid overtightening. Image below is for demonstration purposes - thermal cycler lid should be closed when incubating the cassette.

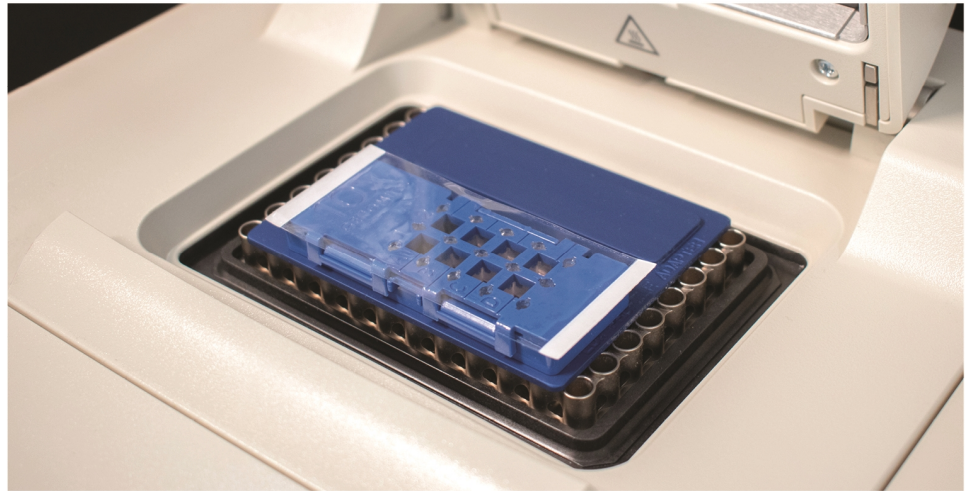

Cassettes with PN-3000811/3000812 are only compatible with the Low Profile Thermocycler Adapter. Use of the wrong Thermocycler Adapter may cause inconsistent heating and slide breakage.

Incubation at Room Temperature

- Place the slide/cassette on a flat, clean, nonabsorbent work surface.

Tissue Detachment on Tissue Slides



- Monitor section adhesion on tissue slides throughout the workflow.
- Ensure that tissue sections are on Superfrost Plus or positively charged slides. A list of tested slides can be found in [Visium CytAssist Tested Slides on page 50](#).
- Tissue detachment before the completion of Probe and Antibody Tag Release during the workflow can negatively impact performance. If observed, contact support@10xgenomics.com.
- For more information, see [Troubleshooting on page 131](#).

10x Magnetic Separator

- Images below are illustrative - actual appearance of magnetic separator may vary. Guidance applies to all 10x Magnetic Separators.
- Offers two positions of the magnets (high and low) relative to a tube, depending on its orientation.
- Flip the magnetic separator over to switch between high (magnet•**High**) or low (magnet•**Low**) positions.
- If using MicroAmp 8-Tube Strips, use the high position (magnet•**High**) only throughout the protocol.

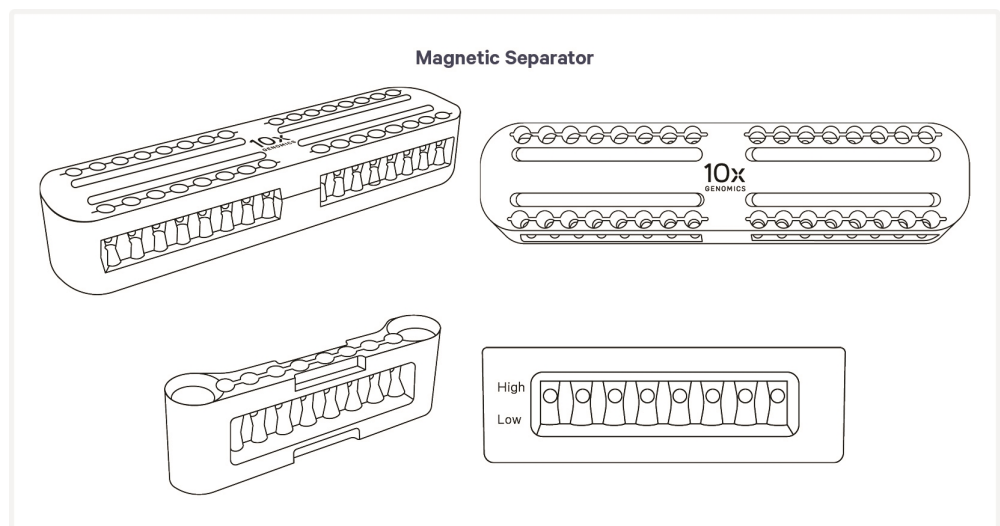

Magnetic Bead Cleanup Steps

- During magnetic bead-based cleanup steps that specify waiting “until the solution clears”, visually confirm clearing of solution before proceeding to the next step. See panel below for an example. If solution is not clear, leave on magnet until separation is complete.
- The time needed for the solution to clear may vary based on specific step, reagents, volume of reagents, etc.
- Images below are illustrative - actual appearance of magnetic separator may vary. Guidance applies to all 10x Magnetic Separators.

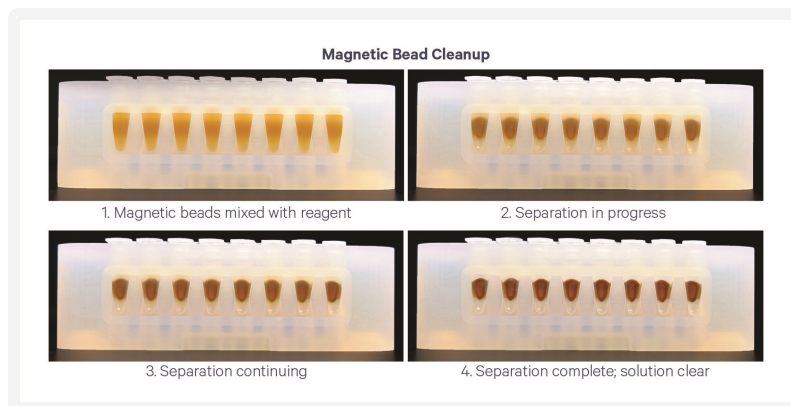

SPRIselect Cleanup & Size Selection

- After aspirating the desired volume of SPRIselect reagent, examine the pipette tips before dispensing to ensure the correct volume is transferred.
- Pipette mix thoroughly as insufficient mixing of sample and SPRIselect reagent will lead to inconsistent results.
- Use fresh preparations of 80% Ethanol.

Sample Indices (i5/i7) in Sample Index PCR

- Choose the appropriate sample index sets to ensure that no sample indices overlap in a multiplexed sequencing run.
- Each well in the Dual Index Plate TS Set A and NT Set A contains a unique i7 and a unique i5 oligonucleotide. These indices can be pooled to enable simultaneous sequencing of Gene Expression and Protein Expression libraries.
- To avoid the risk of cross-contamination, use each plate well only once.
- Record the index plate well location for each sample.

Visium CytAssist

Instrument Orientation	49
Visium CytAssist Tested Slides	50
Instrument Loading Guidelines	51

Instrument Orientation

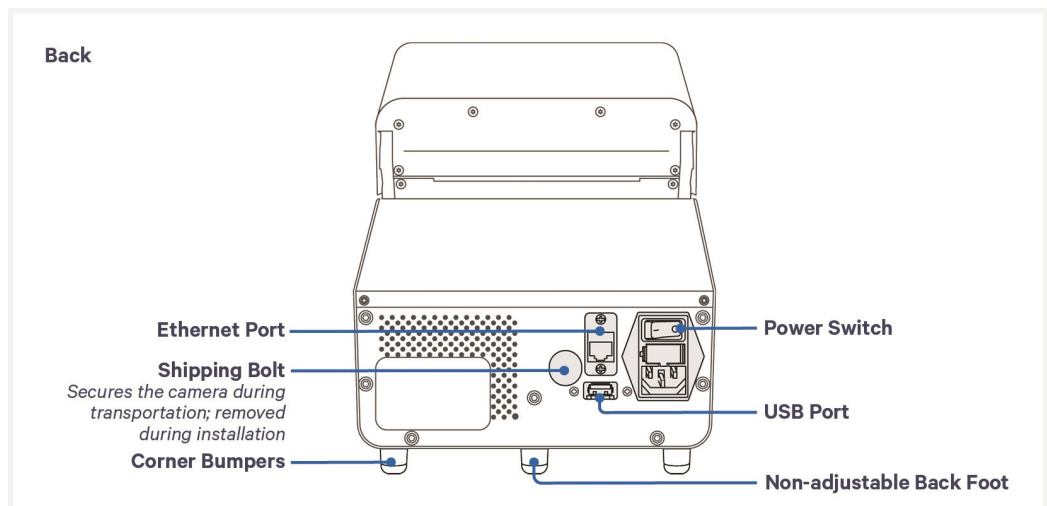
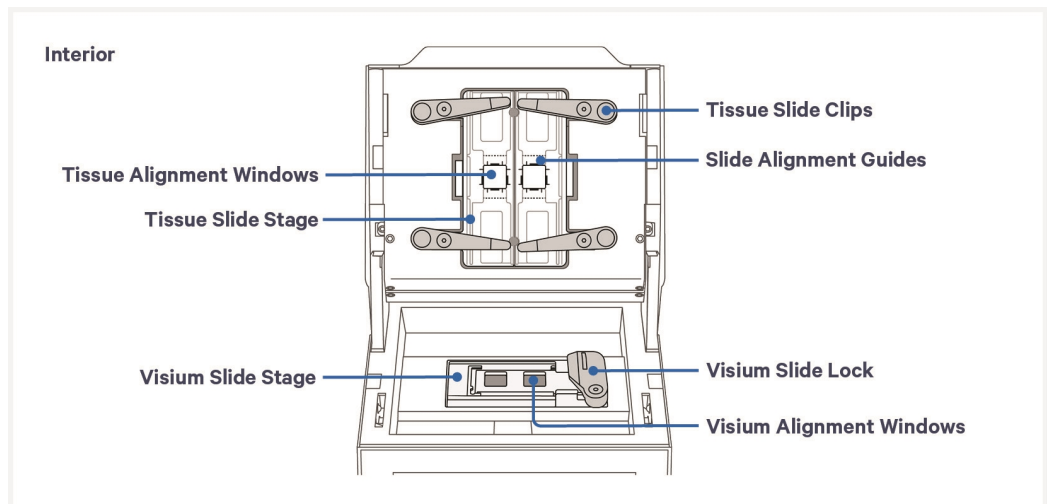
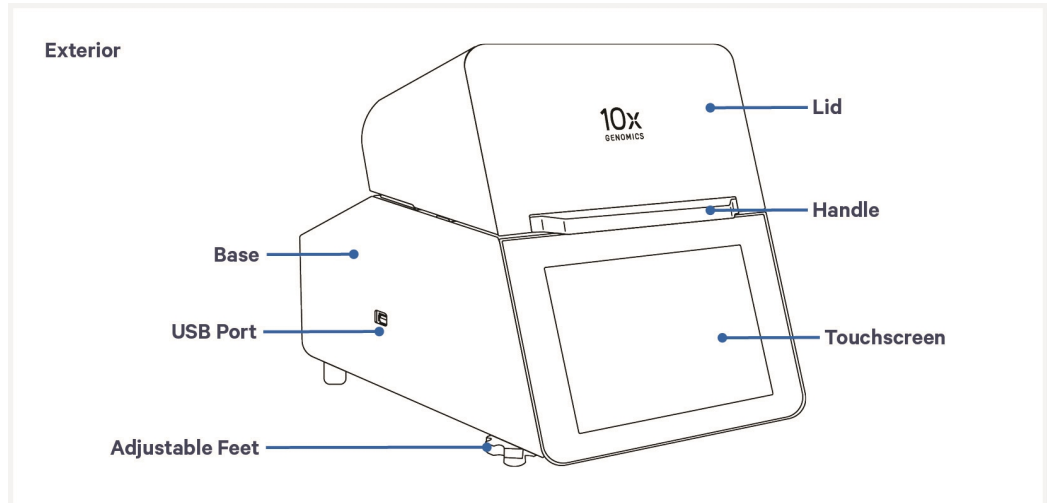

Visium CytAssist Tested Slides

The following slides have been tested for use with the Visium CytAssist instrument.

Item	Length (mm)	Width (mm)	Thickness (mm)	Ground Corners
Epredia Shandon ColorFrost Plus	75.0	25.0	1.0	No
Fisherbrand SuperFrost Plus	75.0	25.0	1.0	Available as either
Sigma-Aldrich Poly Prep Slides	75.0	25.0	1.0	No
VWR SuperFrost Plus Micro Slide, Premium	75.0	25.0	1.0	No

If unsure of slide part number, refer to the diagram below for guidance. Diagrams for verifying that tissue sections are placed in the allowable area can also be found in the Visium CytAssist Quick Reference Cards - Accessory Kit (Document CG000548).

While slides are specified as being 25 x 75 mm, manufacturing tolerances may lead to dimensions that are incompatible with 10x Genomics products. Slide dimensions must be within 24.8 mm - 25.3 mm (width) and 74.4 mm - 76.2 mm (length) to fit the Visium CytAssist Tissue Slide Cassette. Minimum slide dimensions: 24.8 x 74.4 mm. Maximum slide dimensions: 25.3 x 76.2 mm.

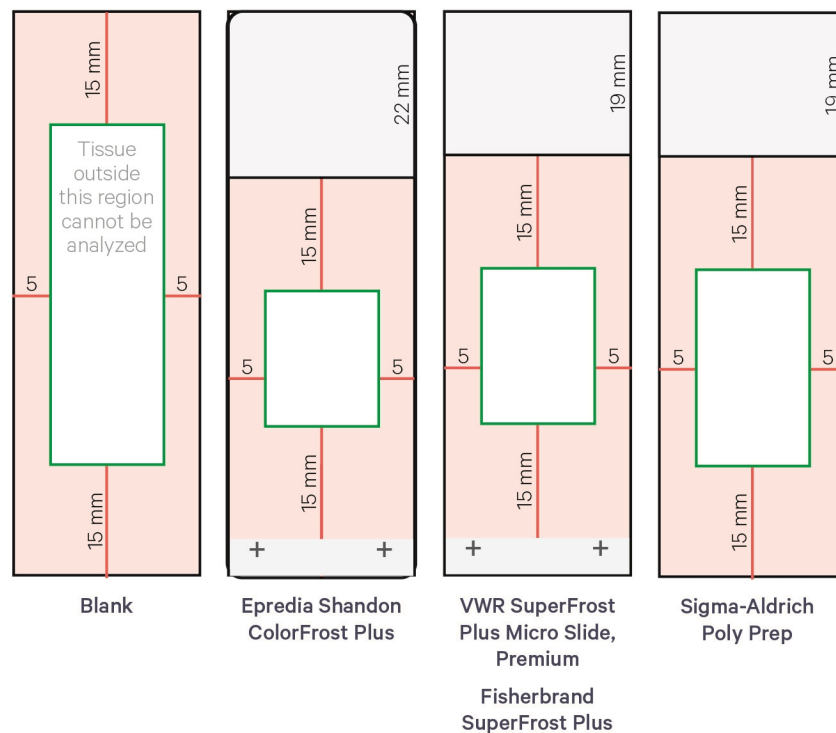

Instrument Loading Guidelines

- Ensure tissue section placement is compatible with Visium CytAssist by using the Visium CytAssist Accessory Kit Quick Reference Card (CG000548). A list of tested slide types and allowable tissue areas can be found in the CytAssist Tested Slides section.
- Consult the Visium CytAssist Training Kit UG (CG000549) for information on practicing tissue slide loading.
- Each tissue slide may be used for one Capture Area on a Visium CytAssist Gene Expression v2 Slide.

Tissue Slide Loading

- a. Ensure the tissue on each slide fits within the alignment guides of the Tissue Slide Stage.
- b. Align tissue within the center of the 6.5 mm slide alignment guides (rectangles) or the 11 mm slide alignment guides (lines) on either the left or right side of the stage.

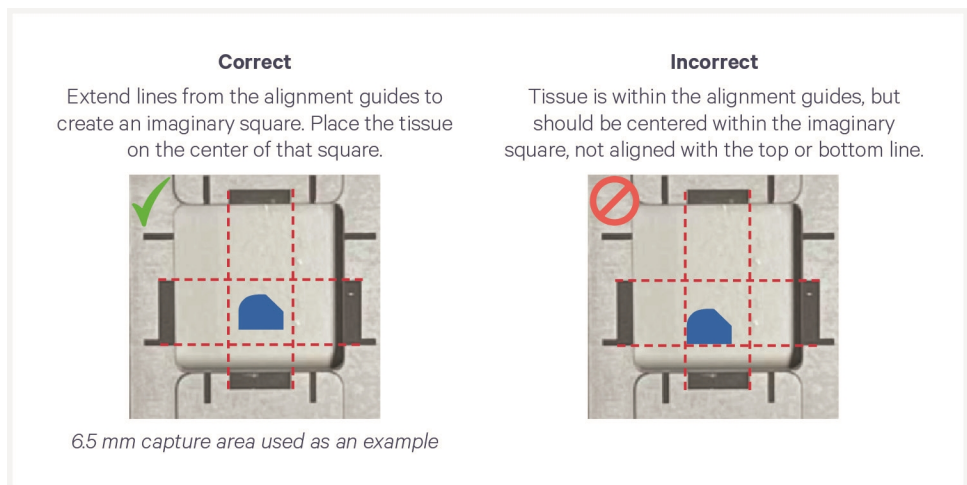
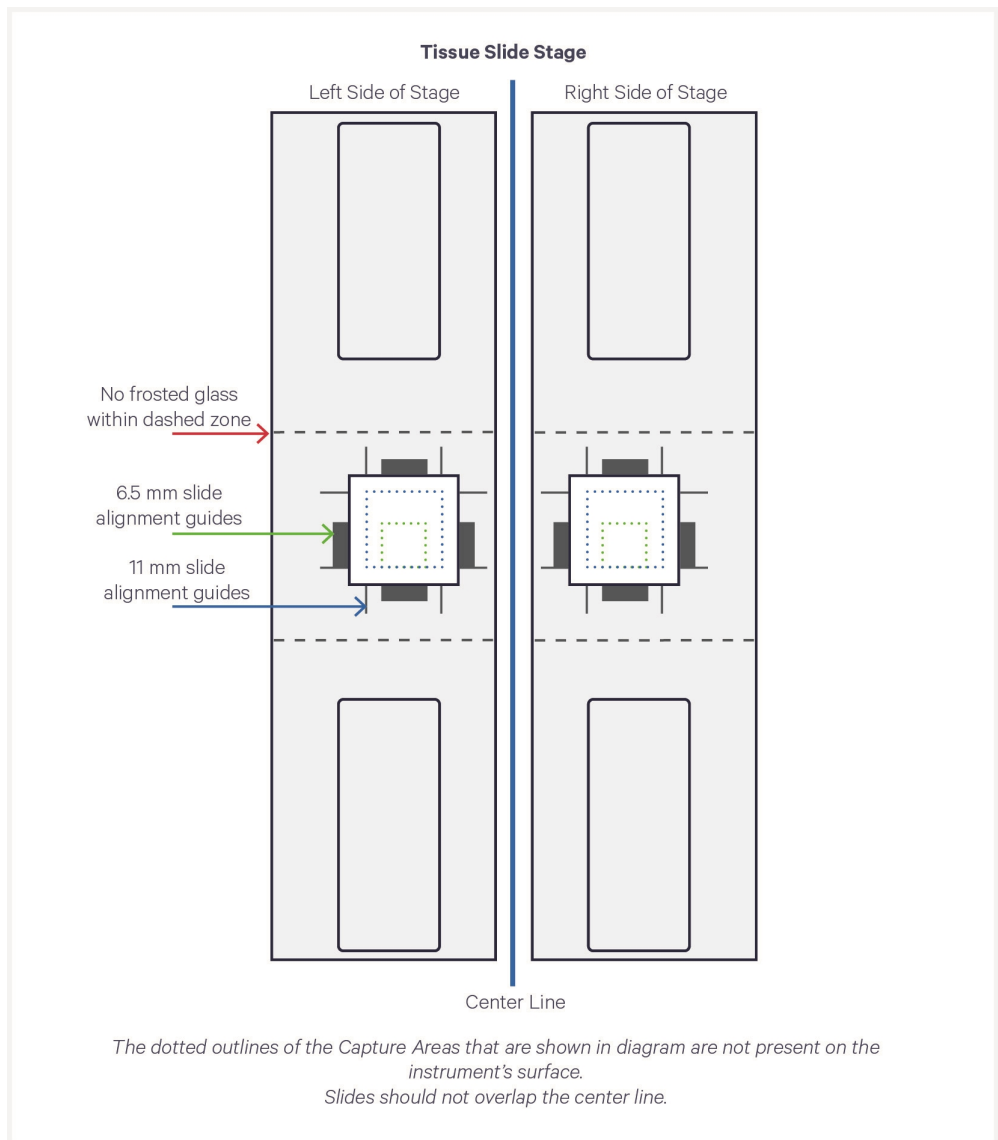

- c. If necessary, rotate the slide 180° as shown. Place off-center tissues closer to the center line (shown as a blue line in the image below). Slides should not overlap the center line.

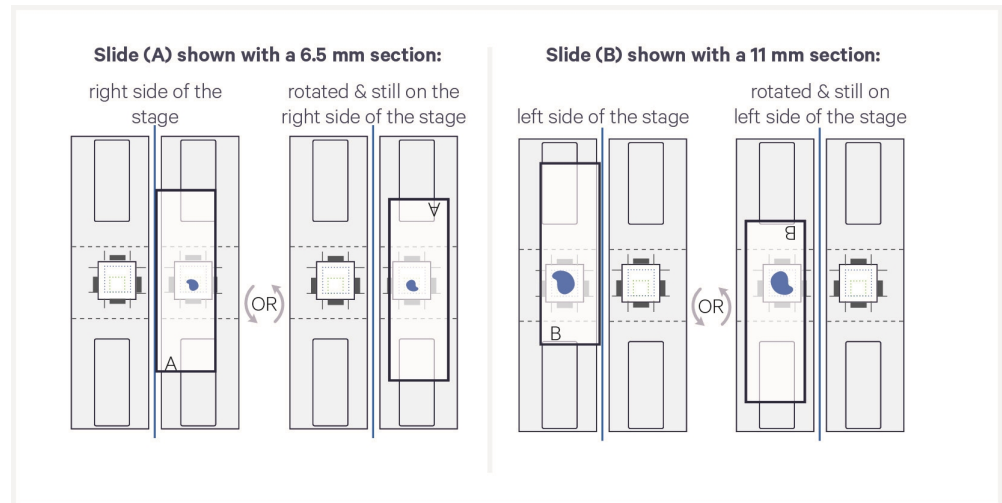

Overlay of a 11 mm fiducial frame and the alignment guides

Note that the **outside** of the alignment guides mark the boundary of the fiducial frame on a Visium CytAssist Slide capture area.

When placing a tissue slide on the Tissue Slide Stage, tissue may come up to the edge of the 11 mm alignment guides.

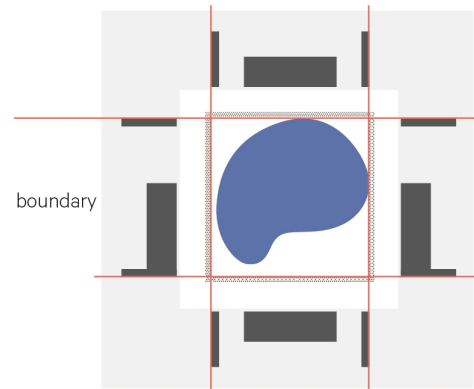

The image below demonstrates how movement of the Tissue Slides affects where target molecules will end up on the Visium slide.

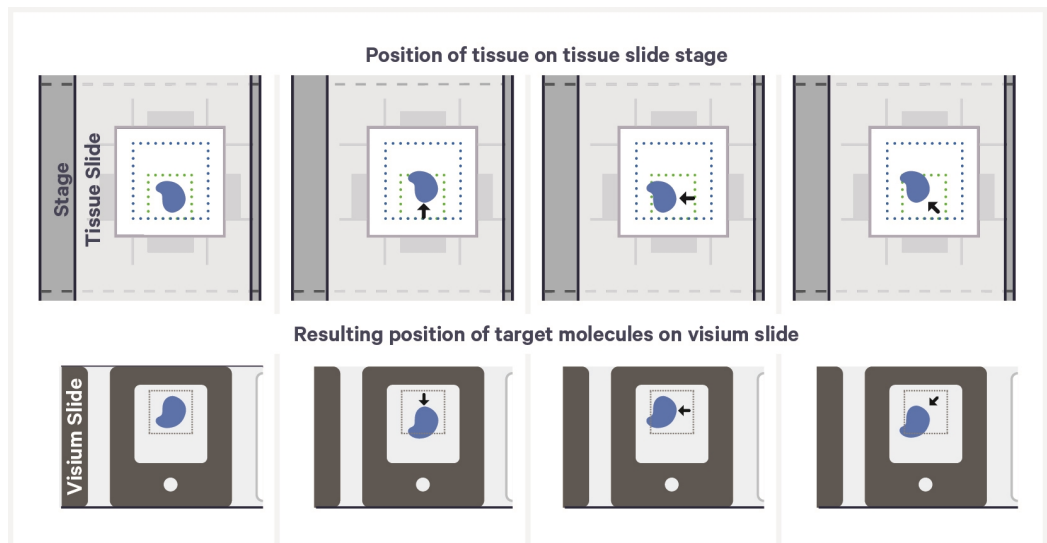

- d.** Press down on the wide end of clip to lift and pivot the narrow end of the clip. Pivot the clips to their outermost position.

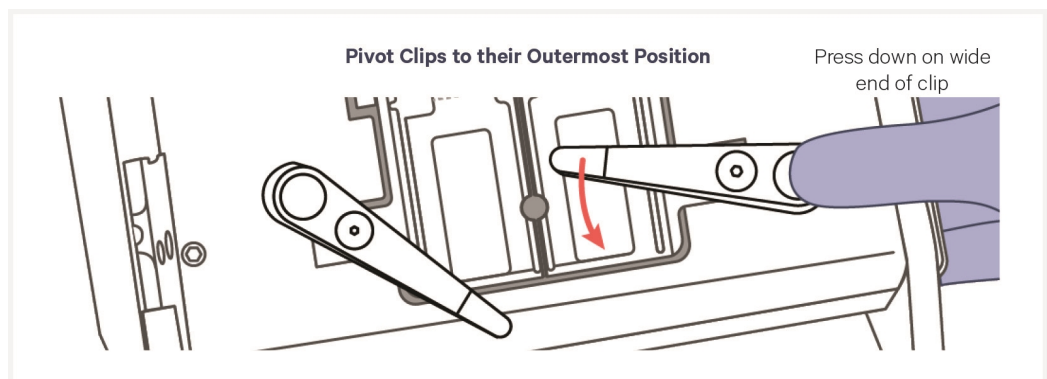

- e.** Lay the tissue slide flat against the stage surface. Both hands needed: use one hand to hold the slide in place and the other to pivot the clips and overlap the slide. Ensure that at least one clip secures the slide before adjusting the position further.
- f.** Use fingers to finely adjust the position of the tissue within the alignment guides.

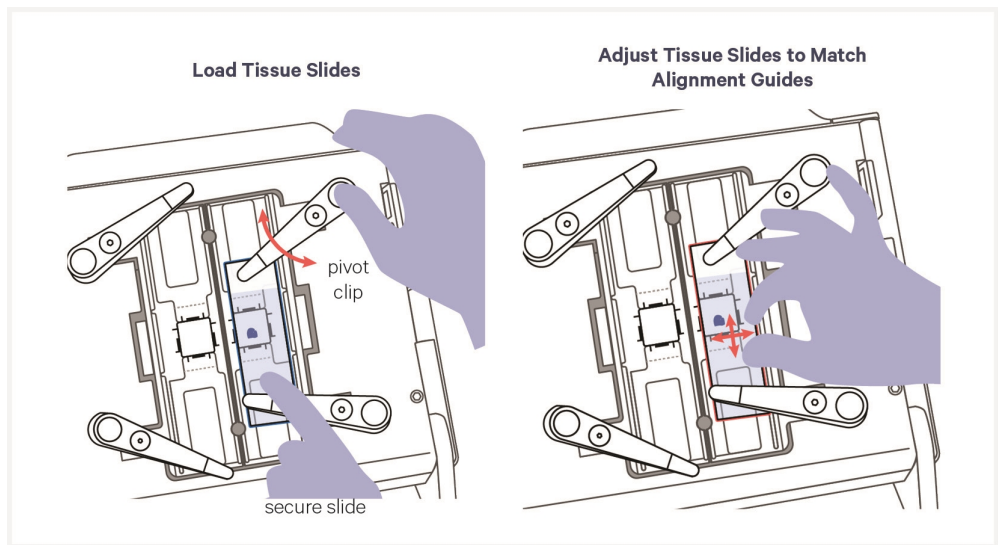

- g. If only one tissue on one slide will be analyzed, use a blank slide for the second position on the Tissue Slide Stage.

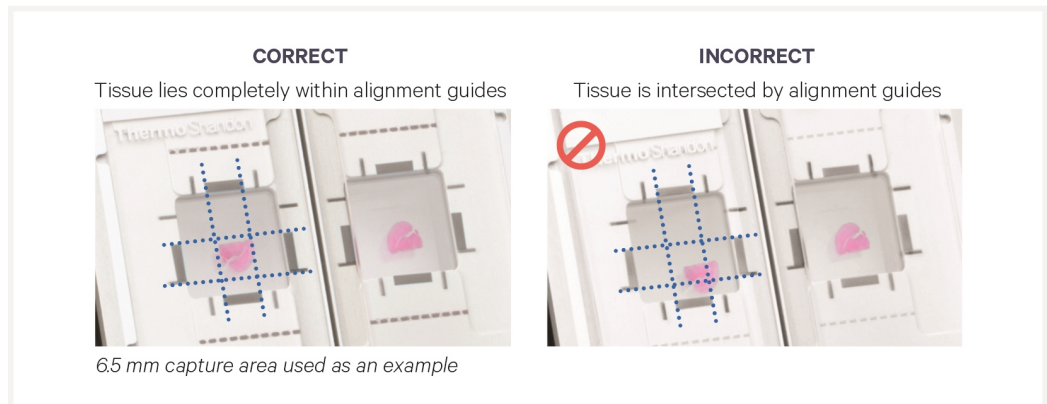
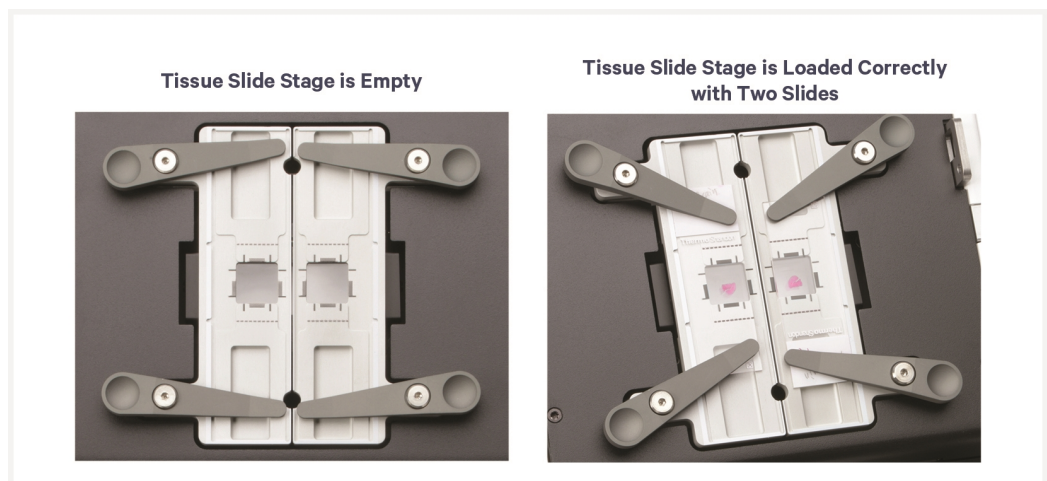

Visium CytAssist Spatial Slide Loading

Before loading, record the slide serial number and note which tissue is placed in which Capture Area. Note which Capture Area will be placed on which side of the Visium Slide Stage (Left = D1, Right = A1).

- a. Open the Visium Slide Lock by using one finger to pivot.
- b. Line up the slide with the label face up and oriented to the right.
- c. Fit the slide within the raised grooves on the left, top, and bottom.

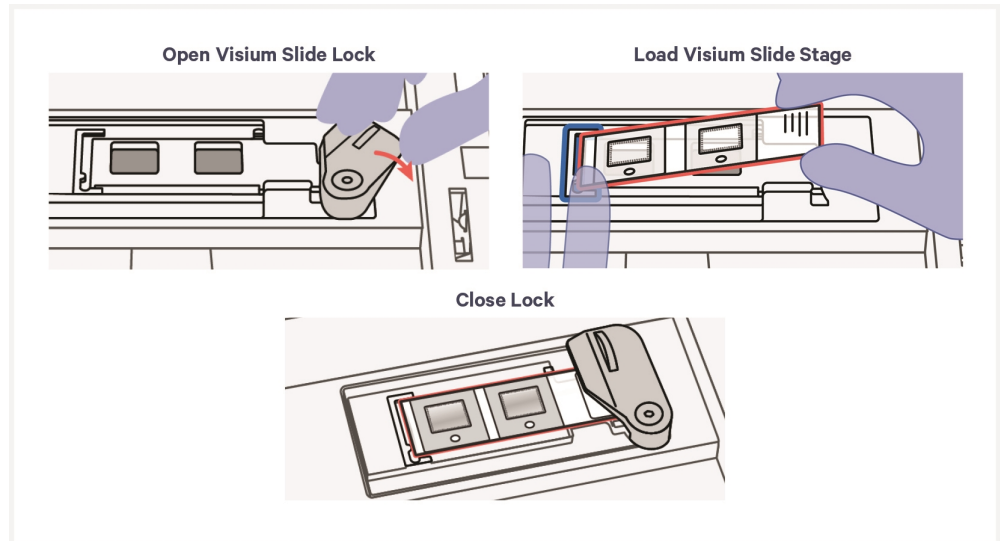

- d. Hold the slide in place with one hand while slowly closing the Visium Slide Lock. The lock will partially obscure the slide label when correctly secured. Close lock gently to avoid damaging the slide. In the images below, the red outlined slide does not line up appropriately with the blue outlined stage.

Visium Slide Stage is Loaded Correctly with One Slide

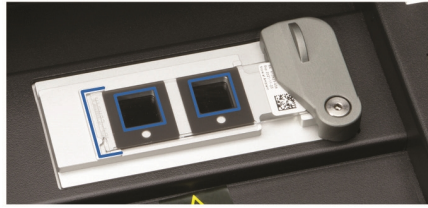

Slide fits inside the grooves.
Label on the right is partially obscured by the lock.
Capture areas line up with alignment windows.

INCORRECT

Slide does not fit inside the grooves.
Capture areas do not line up with alignment windows.

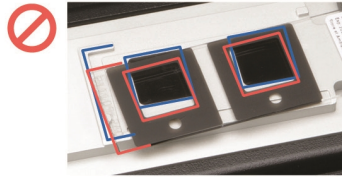

INCORRECT

Label is on the left.
Capture areas do not line up with alignment windows.

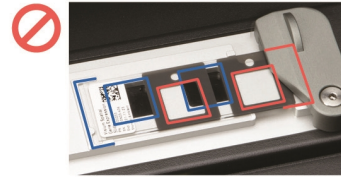

Sample Preparation & Staining Guidelines

Sample Preparation

Proper tissue handling and preparation techniques preserve the morphological quality of the tissue sections and the integrity of proteins and mRNA transcripts. Maintaining high-quality RNA is critical to assay performance.

Before performing the protocol steps in this User Guide, ensure that all samples have followed the appropriate Tissue Preparation protocols as described in the [Workflow Overview on page 20](#). Additionally, if using an add-on antibody, optimize the antibody concentration before this User Guide according to the Visium CytAssist Spatial Gene and Protein Expression Add-on Antibody Optimization Protocol (CG000664). Listed below are key considerations described in these tissue preparation protocols.

Key Considerations

Slide Handling (before tissue placement)

- Store unused slides in original packaging and keep sealed until use.

FFPE Tissue Sectioning & Section Placement

- Assess RNA quality of the FFPE tissue block or from H&E stained archived sections.
- Practice sectioning and section placement with a nonexperimental block before placing sections on slides.
- Section the tissue block and place sections on compatible blank slides using a water bath.
- Place tissue sections on the allowable area on the slide. Allowable area may vary depending on slide choice. See [CytAssist Tested Slides](#) for more information.

Tissue Slide Handling

- Ensure slides are completely dried after tissue placement.
- Store the slides containing FFPE sections for up to two weeks in a desiccator at room temperature.

Step 1:

DNase Treatment

1.0 Get Started	61
1.1 DNase Treatment	62

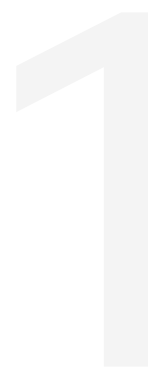

1.0 Get Started

Each 10x Genomics reagent tube is enough for two 6.5 mm Visium slides or one 11 mm Visium slide.

Items	10x PN	Preparation & Handling	Storage
Equilibrate to room temperature			
<input type="checkbox"/> ●	DNase Buffer	Tube: 2000882 Kit: 1000603	Maintain at room temperature. -20°C
Place on ice			
<input type="checkbox"/> ●	DNase	Tube: 2000881 Kit: 1000603	Thaw on ice. -20°C
Obtain			
<input type="checkbox"/>	Nuclease-free Water	-	- Ambient

1.1 DNase Treatment



Before starting this protocol, ensure that tissue sections have been stained according to the appropriate protocol. These staining protocols include Decrosslinking, an important step that must be performed before starting the assay. Refer to [Workflow Overview on page 20](#) for more information.



During reagent removal steps, ensure that **ALL the liquid is removed** from the wells. See Tips & Best Practices for guidance on Reagent Removal.

■ denotes volumes for 6.5 mm gaskets and ▲ denotes volumes for 11 mm gaskets.

- a. Prepare a thermal cycler with the following two incubation protocols. Start the DNase Treatment program.

DNase Treatment		
Lid Temperature	Reaction Volume	Run Time
37°C (lid may be turned off if the instrument does not enable 37°C)	100 µl	30 Min

Step	Temperature	Time hh:mm:ss
Pre-equilibrate	37°C	Hold
DNase Treatment	37°C	00:30:00

DNase Inactivation		
Lid Temperature	Reaction Volume	Run Time
75°C	100 µl	5 Min

Step	Temperature	Time hh:mm:ss
Heat Inactivation	75°C	00:05:00
Hold	22°C	Hold

Prepare DNase Mix according to the appropriate table shortly before use. Add reagents in the order listed. Maintain on ice until use. Pipette mix 10x and centrifuge briefly.



6.5 mm Gaskets					
DNase Mix	10x PN	1X (μl)	2X +10% (μl)	4X +10% (μl)	
● DNase Buffer	2000882	35.0	77.0	154.0	
Nuclease-free Water	-	28.0	61.6	123.2	
● DNase	2000881	7.0	15.4	30.8	
Total	-	70.0	154.0	308.0	



11 mm Gaskets					
DNase Mix	10x PN	1X (μl)	2X +10% (μl)	4X +10% (μl)	
● DNase Buffer	2000882	70.0	154.0	308.0	
Nuclease-free Water	-	56.0	123.2	246.4	
● DNase	2000881	14.0	30.8	61.6	
Total	-	140.0	308.0	616.0	

- b. Retrieve Tissue Slide Cassettes containing H&E stained or IF stained sections and peel back Visium Slide Seal.
- c. Using a pipette, remove all buffer from each well at the well corners. For H&E stained slides, remove all Decrosslinking buffer. For IF stained slides, remove all PBS.
- d. Add **■70 μl** or **▲ 140 μl** DNase Mix along the side of each well to uniformly cover the tissue sections, without introducing bubbles.
- e. Re-apply Visium Slide Seal on each Tissue Slide Cassette and place on the Low Profile Thermocycler Adapter on the thermal cycler. Close the thermal cycler lid.
- f. Skip Pre-equilibrate step to initiate DNase Treatment.
- g. After DNase Treatment, **immediately** start the DNase Inactivation program on the thermal cycler.
- h. Discard gloves and clean workstation before Probe Hybridization.

Step 2:

Probe Hybridization

2.0 Get Started	65
2.1 Probe Hybridization	66

2

2.0 Get Started

Each 10x Genomics reagent tube is enough for two 6.5 mm Visium Slides (four Tissue Slides) or one 11 mm Visium slide. Number of reactions in reagent preparation tables refers to the number of Tissue Slides.

Items	10x PN	Preparation & Handling	Storage	
Equilibrate to room temperature				
<input type="checkbox"/>	FFPE Hyb Buffer	Tube: 2000423 Kit: 1000466	Thaw at room temperature. If precipitate persists, heat at 37°C until dissolved. Avoid vortexing to prevent bubble formation. Pipette mix 10x. Keep the buffer at room temperature after thawing and while performing the workflow.	-20°C
<input type="checkbox"/>	Human WT Probes v2 - RHS	Tube: 2000657 Kit: 1000466	Thaw at room temperature. Vortex and centrifuge briefly. Maintain at room temperature.	-20°C
<input type="checkbox"/>	Human WT Probes v2 - LHS	Tube: 2000658 Kit: 1000466	Thaw at room temperature. Vortex and centrifuge briefly. Maintain at room temperature.	-20°C
Place on ice				
Obtain				
<input type="checkbox"/>	Nuclease-free Water	-	-	Ambient
<input type="checkbox"/>	10X PBS, pH 7.4	-	-	Ambient
<input type="checkbox"/>	Visium Slide Seals	Component: 2000284 Kit: 1000519/1000518	See Tips & Best Practices. 3 pre-cut slide seals are necessary for the complete workflow.	Ambient
<input type="checkbox"/>	10% Tween-20	-	-	Ambient

2.1 Probe Hybridization

■ denotes volumes for 6.5 mm gaskets and ▲ denotes volumes for 11 mm gaskets.

- a. Prepare Pre-Hybridization Mix according to the appropriate table shortly before use. Add reagents in the order listed. Vortex and centrifuge briefly. Maintain at **room temperature**.



6.5 mm Gaskets				
Pre-Hybridization Mix	10x PN	1X (μl)	2X +10% (μl)	4X +10% (μl)
Nuclease-free Water	-	402.8	886.0	1,772.1
10X PBS, pH 7.4	-	45.0	99.0	198.0
10% Tween-20	-	2.3	5.0	9.9
Total	-	450.1	990.0	1,980.0



11 mm Gaskets				
Pre-Hybridization Mix	10x PN	1X (μl)	2X +10% (μl)	4X +10% (μl)
Nuclease-free Water	-	805.5	1,772.1	3,544.2
10X PBS, pH 7.4	-	90.0	198.0	396.0
10% Tween-20	-	4.5	9.9	19.8
Total	-	900.0	1,980.0	3,960.0

- b. Retrieve Tissue Slide Cassettes containing DNase-treated sample from thermal cycler.
- c. Remove Visium Slide Seals.
- d. Using a pipette, remove all buffer from each well at well corners.
- e. Add ■**150 μl** or ▲**300 μl** Pre-Hybridization Mix along the side of each well to uniformly cover tissue sections, without introducing bubbles.
- f. Incubate for **5 min** at **room temperature**.

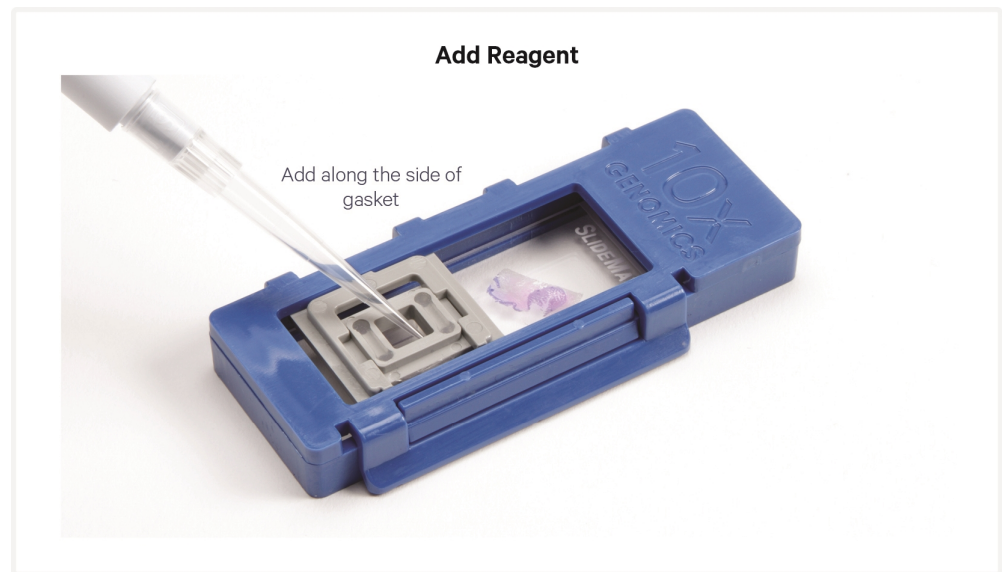

- g.** Using a pipette, remove all buffer from each well at well corners.
- h.** Repeat steps e-g twice more for a total of three washes.
- i.** Place a Low Profile Thermocycler Adapter in the thermal cycler. Prepare thermal cycler with the following incubation protocol and start the program.

Lid Temperature	Reaction Volume	Run Time
50°C	100 µl	Overnight (16 - 24 h)
Step	Temperature	Time hh:mm:ss
Pre-equilibrate	50°C	Hold
Hybridization	50°C	Overnight (16 - 24 h)
Post Hybridization Wash	50°C	Hold

- j. Prepare Probe Hybridization Mix according to the appropriate table shortly before use. Add reagents in the order listed. Keep at **room temperature**. Pipette mix 10x and centrifuge briefly.



6.5 mm Gaskets				
Probe Hybridization Mix	10x PN	1X (μl)	2X +10% (μl)	4X +10% (μl)
Nuclease-free Water	-	10.0	22.0	44.0
FFPE Hyb Buffer	2000423	70.0	154.0	308.0
● Human WT Probes v2 - RHS	2000657	10.0	22.0	44.0
● Human WT Probes v2 - LHS	2000658	10.0	22.0	44.0
Total	-	100.0	220.0	440.0



11 mm Gaskets				
Probe Hybridization Mix	10x PN	1X (μl)	2X +10% (μl)	4X +10% (μl)
Nuclease-free Water	-	19.9	43.8	87.6
FFPE Hyb Buffer	2000423	140.1	308.2	616.4
● Human WT Probes v2 - RHS	2000657	20.0	44.0	88.0
● Human WT Probes v2 - LHS	2000658	20.0	44.0	88.0
Total	-	200.0	440.0	880.0

- k. Add **■100 μl** or **▲200 μl** room temperature Probe Hybridization Mix to each well.
- l. Apply a new pre-cut Visium Slide Seal to each Tissue Slide Cassette and place on the Low Profile Thermocycler Adapter on the thermal cycler. Close the thermal cycler lid.



- m.** Skip Pre-equilibrate step to initiate Hybridization.

Step 3:

Probe Ligation

3.0 Get Started	71
3.1 Post-Hybridization Wash	72
3.2 Probe Ligation	74
3.3 Post-Ligation Wash	76

3

3.0 Get Started

Each 10x Genomics reagent tube is enough for two 6.5 mm Visium Slides (four Tissue Slides) or one 11 mm Visium slide. Number of reactions in reagent preparation tables refers to the number of Tissue Slides.

Items	10x PN	Preparation & Handling	Storage	
Equilibrate to room temperature				
<input type="checkbox"/>	FFPE Post-Hyb Wash Buffer	Tube: 2000424 Kit: 1000466	Thaw at room temperature. If precipitate persists, heat at 37°C until dissolved. Vortex briefly. Flick tube until liquid settles at the bottom of the tube.	-20°C
<input type="checkbox"/> ○	2X Probe Ligation Buffer	Tube: 2000445 Kit: 1000466	Thaw at room temperature until no precipitate remains. Vortex and centrifuge briefly.	-20°C
<input type="checkbox"/>	Post-Ligation Wash Buffer	Tube: 2000419 Kit: 1000466	Thaw at room temperature. If precipitate persists, heat at 37°C until dissolved. Vortex.	-20°C
Place on ice				
<input type="checkbox"/> ○	Probe Ligation Enzyme	Tube: 2000425 Kit: 1000466	Centrifuge briefly. Maintain on ice.	-20°C
Obtain				
<input type="checkbox"/>	Nuclease-free Water	-	-	Ambient
<input type="checkbox"/>	20X SSC Buffer	-	-	Ambient

3.1 Post-Hybridization Wash

■ denotes volumes for 6.5 mm gaskets and ▲ denotes volumes for 11 mm gaskets.

- a. Aliquot FFPE Post-Hyb Wash Buffer (**495 µl/per 6.5 mm sample, 990 µl/per 11 mm sample**) and pre-heat to **50°C** in a water bath or thermomixer. Maintain pre-heated wash buffer at **50°C** throughout washes.
- b. Prepare 2X SSC Buffer according to the appropriate table. Add reagents in the order listed. Maintain at **room temperature**. DO NOT discard excess buffer, as it will be used for subsequent washes in the protocol.



6.5 mm Gaskets						
SSC Buffer	Stock	Final	1X (µl)	2X +10% (µl)	4X +10% (µl)	
SSC	20X	2X	356	781	1,562	
Nuclease-free Water	-	-	3,195	7,029	14,058	
Total	-		3,550*	7,810*	15,620*	



11 mm Gaskets						
SSC Buffer	Stock	Final	1X (µl)	2X +10% (µl)	4X +10% (µl)	
SSC	20X	2X	410	902	1,804	
Nuclease-free Water	-	-	3,690	8,118	16,236	
Total	-		4,100*	9,020*	18,040*	

- c. Remove Visium Tissue Slide Cassettes from Low Profile Thermocycler Adapter and place on a flat, clean work surface.
- TIPS**
- d. Peel back Visium Slide Seals and using a pipette, remove all Probe Hybridization Mix from each well. See Tips and Best Practices for slide seal removal guidance.
 - e. **Immediately** add ■ **150 µl** or ▲ **300 µl** pre-heated FFPE Post-Hyb Wash Buffer to each well. Avoid well drying or cooling to room temperature. Removal and addition of buffers should be done quickly.
 - f. Re-apply Visium Slide Seal on each Tissue Slide Cassette and place on Low Profile Thermocycler Adapter on pre-heated thermal cycler. Close thermal cycler lid.
 - g. Skip the Hybridization step on thermal cycler and initiate Post-Hybridization Wash.

h. Incubate Visium Tissue Slide Cassettes in thermal cycler at **50°C** for **5 min**.



i. Remove Tissue Slide Cassettes from Low Profile Thermocycler Adapter and place on a flat, clean work surface. Exercise caution, as slide is hot.



j. Peel back Visium Slide Seals and using a pipette, remove all FFPE Post-Hyb Wash Buffer from each well.



k. Immediately add **■150 µl** or **▲300 µl** pre-heated FFPE Post-Hyb Wash Buffer to each well. Avoid well drying or cooling to room temperature. Removal and addition of buffers should be done quickly.

l. Re-apply Visium Slide Seal on each Tissue Slide Cassette and place on Low Profile Thermocycler Adapter on pre-heated thermal cycler. Close thermal cycler lid.

m. Incubate in thermal cycler at **50°C** for **5 min**.

n. Repeat steps i-m one more time for a total of three washes.

o. Peel back Visium Slide Seals and remove FFPE Post-Hyb Wash Buffer from each well.

p. Add **■ 150 µl** or **▲ 300 µl** 2X SSC Buffer to each well and re-apply Visium Slide Seal on each Tissue Slide Cassette.

q. Let the Tissue Slide Cassettes cool to **room temperature (~3 min)** before proceeding to the next step.

3.2 Probe Ligation

■ denotes volumes for 6.5 mm gaskets and ▲ denotes volumes for 11 mm gaskets.

- a. Place a Low Profile Thermocycler Adapter onto a thermal cycler (if not already placed), prepare with the following incubation protocol, and start the program.

Lid Temperature	Reaction Volume	Run Time
37°C (lid may be turned off if the instrument does not enable 37°C)	100 µl	1 h

Step	Temperature	Time hh:mm:ss
Pre-equilibrate	37°C	Hold
Ligation	37°C	01:00:00
Hold	4°C	Hold

- b. Prepare Probe Ligation Mix according to the appropriate table shortly before use. Add reagents in the order listed. Pipette mix 10x and centrifuge briefly. DO NOT vortex. Maintain on ice.



6.5 mm Gaskets				
Probe Ligation Mix	10x PN	1X (µl)	2X +10% (µl)	4X +10% (µl)
Nuclease-free Water	-	24.0	52.8	105.6
○ 2X Probe Ligation Buffer	2000445	30.0	66.0	132.0
○ Probe Ligation Enzyme	2000425	6.0	13.2	26.4
Total	-	60.0	132.0	264.0



11 mm Gaskets				
Probe Ligation Mix	10x PN	1X (µl)	2X +10% (µl)	4X +10% (µl)
Nuclease-free Water	-	52.0	114.4	228.8
○ 2X Probe Ligation Buffer	2000445	65.0	143.0	286.0
○ Probe Ligation Enzyme	2000425	13.0	28.6	57.2
Total	-	130.0	286.0	572.0

- c. Remove Visium Slide Seals from each Tissue Slide Cassette and remove all 2X SSC Buffer from each well.
-  d. Add ■ **60 µl** or ▲ **130 µl** Probe Ligation Mix directly to tissue sections in each well, without introducing bubbles. Tap Tissue Slide Cassettes gently to ensure uniform coverage.
- e. Apply a new pre-cut Visium Slide Seal on each Tissue Slide Cassette and place on the Low Profile Thermocycler Adapter on the pre-heated thermal cycler. Close the thermal cycler lid.
- f. Skip Pre-equilibrate step to initiate Ligation.

3.3 Post-Ligation Wash

■ denotes volumes for 6.5 mm gaskets and ▲ denotes volumes for 11 mm gaskets.



Use room temperature Post-Ligation Wash Buffer at first wash step (step 3.3e). Use pre-heated Post-Ligation Wash Buffer at second wash step (step 3.3j).

- a. Pre-heat Post-Ligation Wash Buffer (■ **110 µl/sample** or ▲ **220 µl/sample**) to **57°C**. Only **100 µl** per 6.5 mm sample or **200 µl** per 11 mm sample is needed.
- b. Remove the Tissue Slide Cassettes from the Low Profile Thermocycler Adapter and place on a flat, clean work surface.
- c. Immediately prepare thermal cycler with the following incubation protocol and start the program.

Lid Temperature	Reaction Volume	Run Time
57°C	100 µl	-
Step	Temperature	Time
Incubate	57°C	Hold

- d. Remove Visium Slide Seals from each Tissue Slide Cassette and using a pipette, remove all Probe Ligation Mix from each well.
- e. Immediately add ■ **100 µl** or ▲ **200 µl room temperature** Post-Ligation Wash Buffer to each well. Removal and addition of buffers should be done quickly.
- f. Apply a new pre-cut Visium Slide Seal on each Tissue Slide Cassette and place on Low Profile Thermocycler Adapter on pre-heated thermal cycler. Close thermal cycler lid.
- g. Incubate at **57°C** for **5 min**.
- h. Remove Tissue Slide Cassettes from the Low Profile Thermocycler Adapter and place on a flat, clean work surface.
- i. Peel back Visium Slide Seals and using a pipette, remove all Post-Ligation Wash Buffer from each well.
- j. Add ■ **100 µl** or ▲ **200 µl pre-heated** Post-Ligation Wash Buffer to each well.
- k. Re-apply Visium Slide Seal on Tissue Slide Cassette and place on Low Profile Thermocycler Adapter on pre-heated thermal cycler. Close thermal cycler lid.
- l. Incubate at **57°C** for **5 min**.



- m.** Remove Tissue Slide Cassettes from Low Profile Thermocycler Adapter and place on a flat, clean work surface.
- n.** Peel back Visium Slide Seals and using a pipette, remove all Post Ligation Wash Buffer from each well.
- o.** Add ■ **150 µl** or ▲ **300 µl** 2X SSC Buffer prepared in [3.1 Post-Hybridization Wash on page 72](#) to each well.
- p.** Remove all 2X SSC Buffer from each well.
- q.** Add ■ **150 µl** or ▲ **300 µl** 2X SSC Buffer to each well.
- r.** Re-apply Visium Slide Seals on each Tissue Slide Cassette.
-  **s.** Store at **4°C** for up to **24 h** or allow to come to room temperature for **5 min** and proceed to next step.

Step 4:



Protein Labeling

4.0 Get Started	79
4.1 Tissue Blocking	80
4.2 Antibody Incubation	81
4.3 Post-Antibody Incubation Wash	83



4.0 Get Started

Each 10x Genomics reagent tube is enough for two 6.5 mm Visium slides or one 11 mm Visium slide.

Items	10x PN	Preparation & Handling	Storage
Place on ice			
<input type="checkbox"/> 	RNase Inhibitor Tube: 2000556 Kit: 1000603	Pipette mix, centrifuge briefly. Maintain on ice until ready to use.	-20°C
Equilibrate at room temperature			
<input type="checkbox"/> 	Human Immune Cell Panel Tube: 2000699 Kit: 1000607	Centrifuge briefly. Maintain at room temperature until ready to use.	-20°C
<input type="checkbox"/> 	Block and Stain Buffer Tube: 2000554 Kit: 1000436	Thaw at room temperature. Precipitate may be present after thawing. Pipette mix 10-15x with pipette set to 750 µl until solution is homogenous. Maintain at room temperature until ready to use.	-20°C
Obtain			
<input type="checkbox"/>	Centrifuge -	Equilibrate centrifuge to 4°C.	Ambient
<input type="checkbox"/>	Nuclease-free Water -	-	Ambient
<input type="checkbox"/>	2X SSC -	Prepared in 3.1 Post-Hybridization Wash on page 72 .	Ambient
<input type="checkbox"/>	10% Tween-20 -	-	Ambient
<input type="checkbox"/>	10X PBS Buffer -	-	Ambient
<input type="checkbox"/>	Visium Slide Seals Component: 2000284 Kit: 1000519/1000518	See Tips & Best Practices.	Ambient

4.1 Tissue Blocking

■ denotes volumes for 6.5 mm gaskets and ▲ denotes volumes for 11 mm gaskets.

- a. Prepare Blocking Mix according to the appropriate table, add reagents in the order listed. Pipette mix 10x and centrifuge briefly. Maintain at **room temperature**.



6.5 mm Gaskets				
Blocking Mix	10x PN	1X (μl)	2X +10% (μl)	4X +10% (μl)
Nuclease-free Water	-	72.5	159.5	319.0
● Block and Stain Buffer	2000554	25.0	55.0	110.0
● RNase Inhibitor	2000556	2.5	5.5	11.0
Total	-	100.0	220.0	440.0



11 mm Gaskets				
Blocking Mix	10x PN	1X (μl)	2X +10% (μl)	4X +10% (μl)
Nuclease-free Water	-	145.0	319.0	638.0
● Block and Stain Buffer	2000554	50.0	110.0	220.0
● RNase Inhibitor	2000556	5.0	11.0	22.0
Total	-	200.0	440.0	880.0

- b. Remove Visium Slide Seals from each Tissue Slide Cassette and remove all 2X SSC Buffer from each well.
- c. Add ■ **100 μl** or ▲ **200 μl** Blocking Mix to each well.
- d. Apply a new pre-cut Visium Slide Seal to each Tissue Slide Cassette and incubate at **room temperature** for **1 h**.
- e. **Immediately** proceed to next step during incubation and begin preparing staining mixes.



4.2 Antibody Incubation

■ denotes volumes for 6.5 mm gaskets and ▲ denotes volumes for 11 mm gaskets.

- a. Prepare Staining Mix according to the table below. Add reagents in the order listed. The Staining Mix described below is sufficient for one 10x Genomics antibody panel tube. Pipette mix 15x with pipette set to 200 μ l. Briefly centrifuge.



One tube is enough for two 6.5 mm samples. If working with two 11 mm samples, two Human Immune Cell Profiling Panel tubes will be required.

Staining Mix	10x PN	Volume (μ l)
Nuclease-free Water	-	147*
 Block and Stain Buffer	2000554	52.5
 RNase Inhibitor	2000556	10.5
Total	-	210.0*

*If add-on antibodies will be used, add them to this staining mix and reduce the amount of nuclease-free water such that the total volume remains at 210 μ l after add-on antibody addition. If adding multiple add-on antibodies, they should be pooled together according to the Visium CytAssist Spatial Gene and Protein Expression Add-on Antibody Optimization Demonstrated Protocol (CG000664).

- b. Prepare a thermal cycler with the following incubation protocol and start the program.

Lid Temperature	Reaction Volume	Run Time
30°C (lid may be turned off if the instrument does not enable 30°C)	100 μ l	Overnight (16 - 24 h)
Step	Temperature	Time hh:mm:ss
Pre-equilibrate	22°C	Hold
Antibody Incubation	22°C	Overnight (16 - 24 h)
Hold	22°C	Hold

- c. Briefly centrifuge Human Immune Cell Profiling Panel.
- d. Add **210 μ l** Staining Mix to each tube of Human Immune Cell Profiling Panel (PN-2000699). One antibody panel tube is enough for two 6.5 mm

samples. Two 11 mm samples will require two tubes.



- e.** Pipette mix 15x with pipette set to 200 μ l. Briefly centrifuge.
- f.** If using multiple Human Immune Cell Profiling Panel tubes, briefly centrifuge each panel tube after adding Staining Mix. Combine panels into a single 1.5 ml tube and proceed.
- g.** Incubate resuspended antibody panel for **30 min** at **4°C**.
- h.** During the last **10 min** of Tissue Blocking, centrifuge resuspended antibody panel at **14,000 rcf** for **10 min** at **4°C**.
- i.** Peel back Visium Slide Seals on Tissue Slide Cassettes.
- j.** Remove all Blocking Mix from each well.
- k.** Add **■100 μ l** or **▲200 μ l** centrifuged, resuspended antibody panel supernatant to each well. Avoid touching the bottom of the tube.
- l.** Re-apply Visium Slide Seals on each Tissue Slide Cassette and place on the Low Profile Thermocycler Adapter on the thermal cycler. Close the thermal cycler lid.
- m.** Skip Pre-equilibrate step to initiate overnight Antibody Incubation.

4.3 Post-Antibody Incubation Wash

- a. Prepare Washing Buffer according to the appropriate table. Add reagents in the order listed. Slowly invert tube 10x and centrifuge briefly.



6.5 mm Gaskets				
Washing Buffer	10x PN	1X (μl)	2X +10% (μl)	4X +10% (μl)
Nuclease-free Water	-	516.0	1,135.2	2,270.4
10X PBS Buffer, pH 7.4	-	60.0	132.0	264.0
Tween-20, 10%	-	24.0	52.8	105.6
Total	-	600.0	1,320.0	2,640.0



11 mm Gaskets				
Washing Buffer	10x PN	1X (μl)	2X +10% (μl)	4X +10% (μl)
Nuclease-free Water	-	1,032.0	2,270.4	4,540.8
10X PBS Buffer, pH 7.4	-	120.0	264.0	528.0
Tween-20, 10%	-	48.0	105.6	211.2
Total	-	1,200.0	2,640.0	5,280.0

- b.** Prepare 1X PBS according to the appropriate table. Add reagents in the order listed. 1X PBS will also be used during step 5.



6.5 mm Gaskets				
1X PBS	10x PN	1X (μl)	2X +10% (μl)	4X +10% (μl)
Nuclease-free Water	-	2,956.5	6,504.3	13,008.6
10X PBS Buffer, pH 7.4	-	328.5	722.7	1,445.4
Total	-	3,285.0	7,227.0	14,454.0



11 mm Gaskets				
1X PBS	10x PN	1X (μl)	2X +10% (μl)	4X +10% (μl)
Nuclease-free Water	-	3,213.0	7,068.6	14,137.2
10X PBS Buffer, pH 7.4	-	357.0	785.4	1,570.8
Total	-	3,570.0	7,854.0	15,708.0

- c.** Remove Tissue Slide Cassettes from the Low Profile Thermocycler Adapter and place on a flat, clean work surface.
- d.** Remove Visium Slide Seals and remove all Staining Mix from each well.
- e.** Add **■150 μl** or **▲ 300 μl** Washing Buffer to each well, adding directly onto the tissue without touching the pipette tip to the tissue.
- f.** Incubate at **room temperature** for **5 min**.
- g.** Remove all Washing Buffer from each well.
- h.** **Repeat** steps e-g three times for a total four washes.
- i.** Add **■150 μl** or **▲ 300 μl** 1X PBS to each well.

Step 5:

Probe and Antibody Tag Release & Extension

5.0 Get Started	86
5.1 CytAssist-Enabled RNA Digestion & Tissue Removal	88
5.2 Probe & Antibody Tag Extension	98
5.3 Probe & Antibody Tag Elution	99



5.0 Get Started



Each 10x Genomics reagent tube is enough for two 6.5 mm Visium Slides (four tissue slides) or one 11 mm Visium slide. Number of reactions in reagent preparation tables refers to the number of Tissue Slides. After instrument run, number of reactions refers to the number of wells in a Visium Cassette.



Ensure that the Visium CytAssist is powered on, is clean, and ready to perform an experimental run.

Items	10x PN	Preparation & Handling	Storage
Equilibrate to room temperature			
<input type="checkbox"/> ● RNase Buffer C	Tube: 2000883 Kit: 1000603	Thaw at room temperature. Pipette mix slowly and thoroughly with a wide-bore pipette. DO NOT vortex.	-20°C
<input type="checkbox"/> ● Extension Buffer	Tube: 2000409 Kit: 1000436	Thaw at room temperature, vortex, centrifuge briefly.	-20°C
<input type="checkbox"/> ● Tissue Removal Enzyme	Tube: 3000387 Kit: 1000436	Pipette mix, centrifuge briefly.	-20°C
Place on ice			
<input type="checkbox"/> ● RNase Enzyme	Tube: 3000593 Kit: 1000436	Pipette mix, centrifuge briefly. Maintain on ice until ready to use. RNase Enzyme is added to the Probe and Antibody Tag Release Mix immediately before running the CytAssist instrument.	-20°C
<input type="checkbox"/> ● Extension Enzyme	Tube: 2000389 Kit: 1000436	Pipette mix, centrifuge briefly. Maintain on ice until ready to use.	-20°C
Obtain			
<input type="checkbox"/> Nuclease-free Water	-	-	Ambient
<input type="checkbox"/> Wide-bore Pipette Tips	-	-	Ambient
<input type="checkbox"/> Tris 1 M, pH 8.0 (Tris-HCl)	-	Manufacturer's recommendations.	Ambient
<input type="checkbox"/> Alcoholic Eosin	-	Manufacturer's recommendations.	Ambient
<input type="checkbox"/> PBS	-	Prepared in 4.3 Post-Antibody Incubation Wash on page 83	Ambient

Items		10x PN	Preparation & Handling	Storage
<input type="checkbox"/>	20X SSC Buffer	-	-	Ambient
<input type="checkbox"/>	2X SSC Buffer	-	Prepared in 3.1 Post-Hybridization Wash on page 72.	Ambient
<input type="checkbox"/>	8 M KOH Solution	-	Manufacturer's recommendations.	Ambient
<input type="checkbox"/>	Visium Cassette	Component: 3000811/ 3000812 Kit: 1000519/1000518	See Tips & Best Practices.	Ambient
<input type="checkbox"/>	Visium Slide Seals	Component: 2000284 Kit: 1000519/1000518	See Tips & Best Practices.	Ambient

5.1 CytAssist-Enabled RNA Digestion & Tissue Removal

■ denotes volumes for 6.5 mm gaskets and ▲ denotes volumes for 11 mm gaskets.

Keep tissue slides at 4°C with 1X PBS until ready for CytAssist run.



- a. Ensure that Visium CytAssist is powered on, clean, and ready for an experimental run.

The home screen is the most common state of the instrument. There are several key functions accessible directly from the home screen.

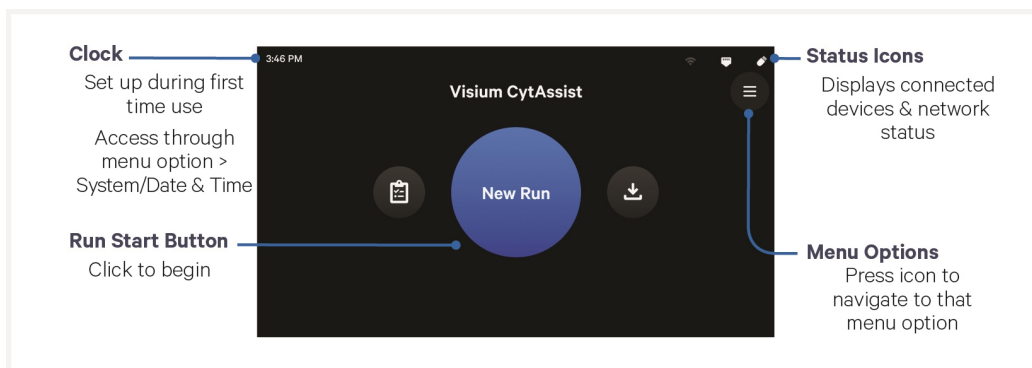

- b. Prepare Probe and Antibody Tag Release Mix shortly before use. Probe and Antibody Tag Release Mix is viscous. Pipette mix thoroughly until solution is homogenous. Avoid generating bubbles. DO NOT vortex. Maintain at room temperature.

	Probe and Antibody Tag Release Mix	10x PN	2 Tissue Slides (μl) (includes overage)
	Nuclease-Free Water	-	11.3
●	RNase Buffer C	2000883	50.0
●	Tissue Removal Enzyme	3000387	4.7
	Total	-	66.0

c. Prepare 1X PBS. Maintain at room temperature.

1X PBS	10x PN	2 Tissue Slides (μ l) (includes overage)	4 Tissue Slides (μ l) (includes overage)
Nuclease-free Water	-	5,940	11,880
10X PBS	-	660	1,320
Total	-	6,600	13,200

d. Prepare 10% Eosin shortly before use. Vortex and centrifuge briefly.

6.5 mm Slides				
10% Eosin	10x PN	1X (μ l)	2X +10% (μ l)	4X +10% (μ l)
Alcoholic Eosin	-	15	33	66
1X PBS	-	135	297	594
Total	-	150	330	660

11 mm Slides				
10% Eosin	10x PN	1X (μ l)	2X +10% (μ l)	4X +10% (μ l)
Alcoholic Eosin	-	30	66	132
1X PBS	-	270	594	1,188
Total	-	300	660	1,320

e. Press blue New Run Button on touchscreen to initiate run.

f. Enter new run information, including:

- Visium Slide serial number. Ensure serial number is accurate.
- Custom run name, temperature, and time (**37°C for 30 min** is recommended for most applications)
- Sample names

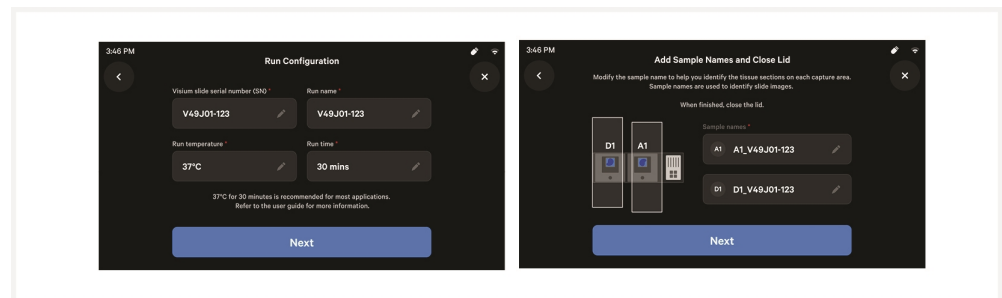

g. Using a pipette, remove all 1X PBS Buffer from each well of the Tissue Slide Cassettes.

- h.** Remove tissue slides from Tissue Slide Cassettes. See Visium CytAssist Tissue Slide Cassette Removal for instructions.
- i.** Add **■ 150 μ l** or **▲ 300 μ l** 10% Eosin to uniformly cover each tissue section per slide.
- j.** Incubate **1 min** at **room temperature**.
- k.** Remove 10% Eosin by holding slide at an angle over a liquid waste container.
- l.** While holding the slide over liquid waste container, rinse with **1 ml 1X PBS**. **DO NOT** pipette directly onto tissue.

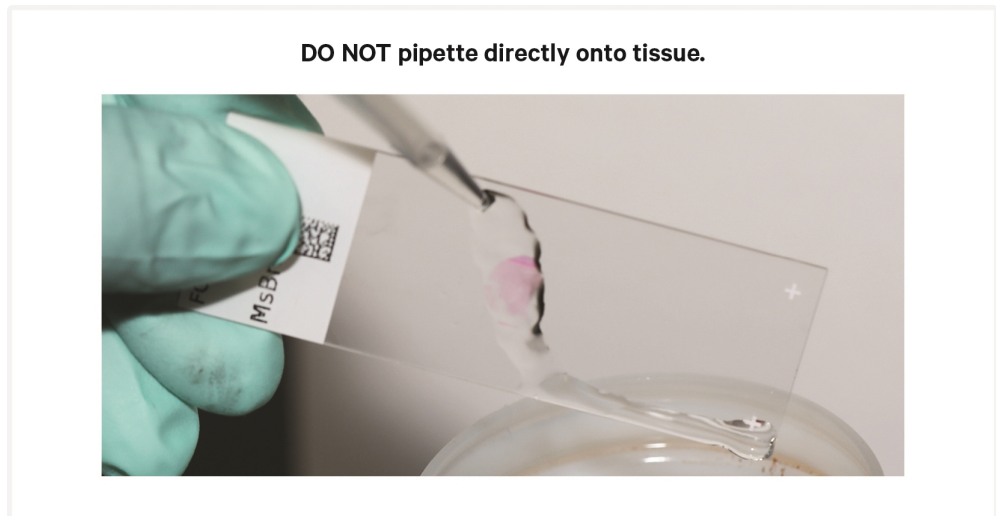

- m.** Repeat step l two more times for a total of three washes.
- n.** Gently flick slide back and forth to remove excess PBS. Remove any excess PBS with a laboratory wipe without damaging the tissue sections.
- o.** Wipe back of tissue slides with a laboratory wipe and load into Visium CytAssist. See [Instrument Loading Guidelines on page 51](#) for more information.

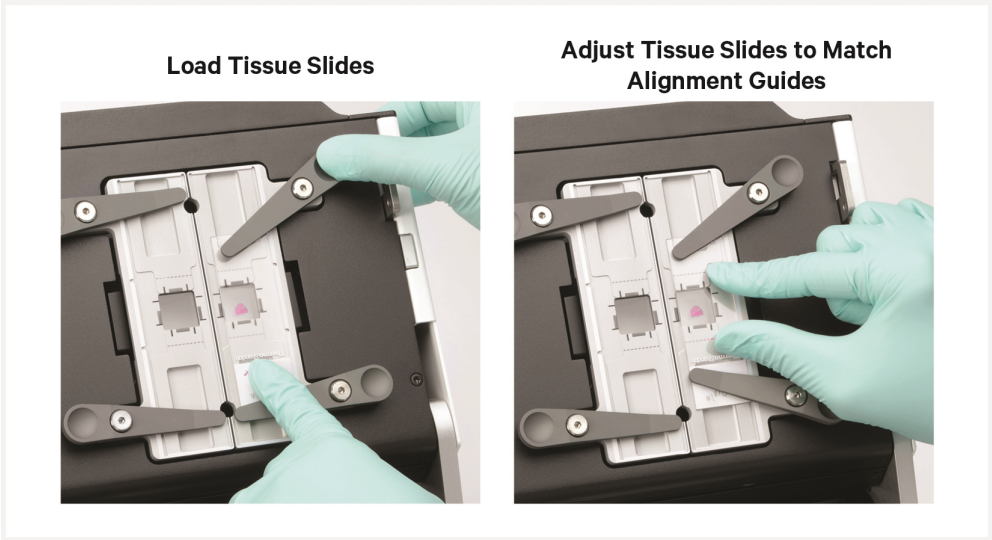

- p.** Load Visium CytAssist Spatial Gene Expression Slide against the grooves of Visium Slide Stage and close Visium Slide Lock.



Visium Slide Stage is Loaded Correctly with One Slide

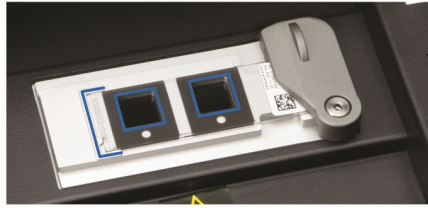

Slide fits inside the grooves.
Label on the right is partially obscured by the lock.
Capture areas line up with alignment windows.

INCORRECT

Slide does not fit inside the grooves.
Capture areas do not line up with alignment windows.

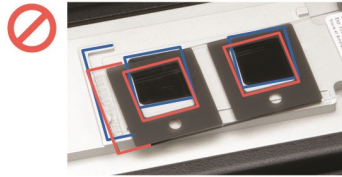

INCORRECT

Label is on the left.
Capture areas do not line up with alignment windows.

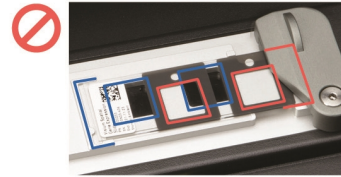

- q.** Add **9 μl** of RNase Enzyme to **66 μl** of Probe and Antibody Tag Release Mix (prepared at step 5.1b). Pipette mix 15x with pipette set to 50 μl . Centrifuge for **10 sec**.

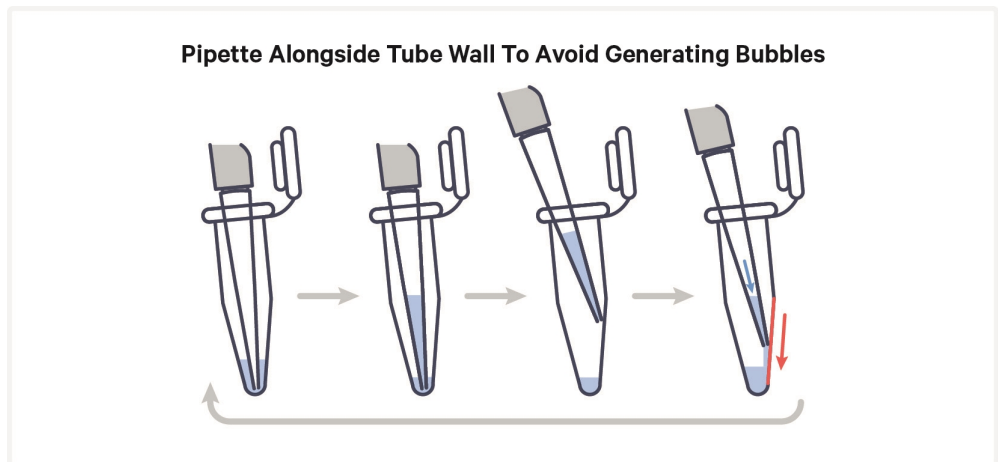

The time between the addition of RNase Enzyme to the Probe and Antibody Tag Release Mix and starting the Visium CytAssist experiment run should be less than **5 min**.

- r.** Slowly dispense **25 μl** of Probe and Antibody Tag Release Mix into the center of each spacer well on the Visium CytAssist Spatial Gene Expression Slide, using a fresh pipette tip for each dispense. Do not push plunger beyond first stop to avoid generating bubbles. If bubbles are generated, pop them with a clean pipette tip.



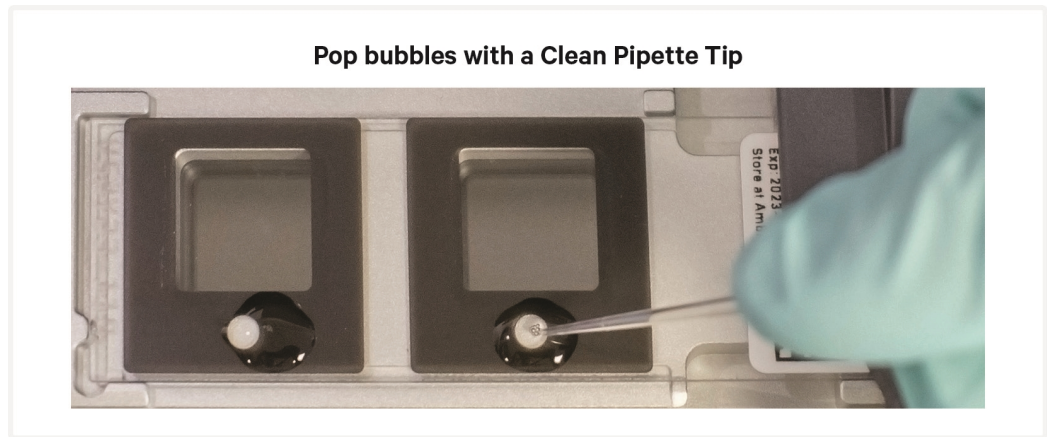

- s. Close lid and press Next.

The home screen will now display a play symbol and run information along the bottom of the screen.

- t. Press play button to start the run. **37°C for 30 min** is recommended for most applications.
 - Midrun progress bar will show the time remaining in the run.

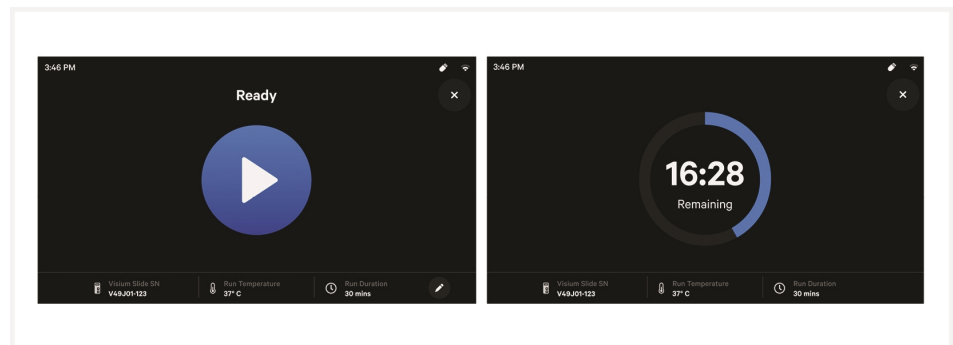

- Yellow before a run begins indicates a user-recoverable error. If an error occurs, follow on-screen prompts.
- u. Place Low Profile Thermocycler Adapter in the thermal cycler. Prepare thermal cycler with the following incubation protocol and start the program.

Lid Temperature	Reaction Volume	Run Time
45°C (lid may be turned off if the instrument does not enable 45°C)	100 µl	15 min
Step	Temperature	Time
Pre-equilibrate	45°C	Hold

Lid Temperature	Reaction Volume	Run Time
Probe Extension	45°C	00:15:00
Hold	4°C	Hold

- v. Prepare Probe and Antibody Tag Extension Mix. Pipette mix. Centrifuge briefly. Maintain on ice.

6.5 mm Slides					
	Probe and Antibody Tag Extension Mix	10x PN	1X (μl)	2X +10% (μl)	4X +10% (μl)
●	Extension Buffer	2000409	73.5	161.7	323.4
●	Extension Enzyme	2000389	1.5	3.3	6.6
	Total	-	75.0	165.0	330.0

11 mm Slides					
	Probe and Antibody Tag Extension Mix	10x PN	1X (μl)	2X +10% (μl)	4X +10% (μl)
●	Extension Buffer	2000409	196.0	431.2	862.4
●	Extension Enzyme	2000389	4.0	8.8	17.6
	Total	-	200.0	440.0	880.0



- w. At the end of a run, the button will display "Done" and a "Run Info" tab at the bottom of the screen. DO NOT allow sample to sit in the Visium CytAssist after run completion. **Immediately** move to next step.
- Green indicates a successfully completed run.
 - Red indicates a failed run/error
 - Yellow at the end of a run indicates an incomplete run.
 - For more information on errors, consult the Visium CytAssist

Instrument User Guide (CG000542).

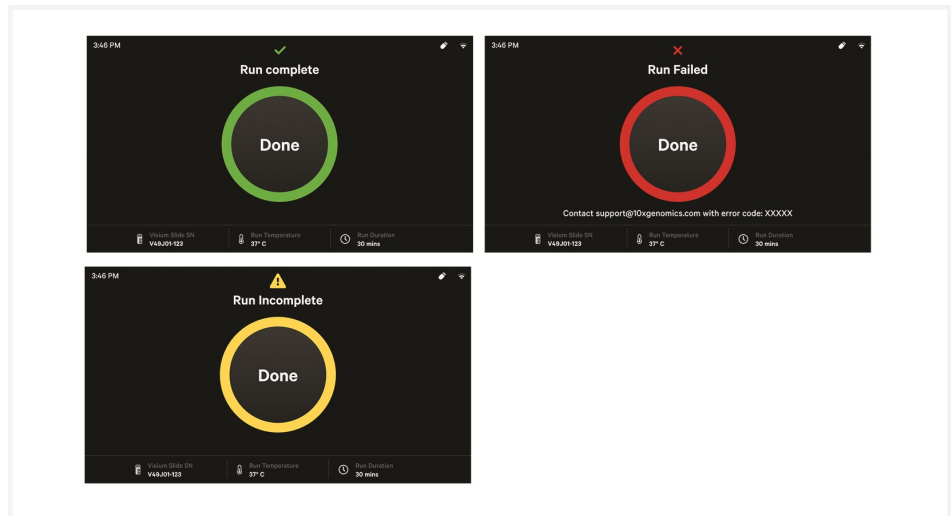

- x. Click "Done" button and open lid. DO NOT power off the instrument at this time, as it needs to process support data. It is normal for the Visium slide to move after opening instrument.
- y. Remove Visium CytAssist Spatial Gene Expression Slide. It is normal if tissue remains of tissue slides after run completion.
- z. While holding Visium CytAssist Spatial Gene Expression Slide over liquid waste container, rinse each Capture Area with **1 ml** 2X SSC. DO NOT pipette directly onto Capture Areas, which are surrounded by the fiducial frames.

Rinse slide near Visium CytAssist instrument to ensure prompt washing of the Capture Areas.

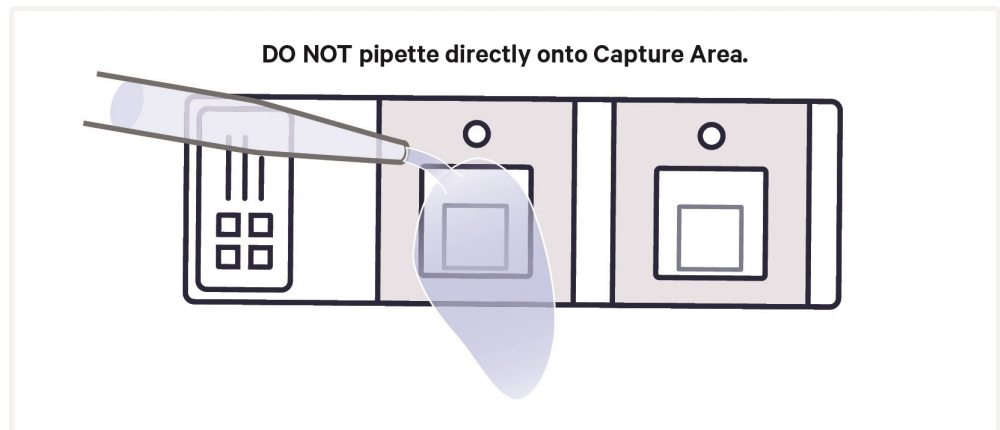

- aa. Repeat step z two more times for a total of three washes per Capture Area.

- ab.** Place Visium CytAssist Spatial Gene Expression slide in a new 6.5 or 11 mm Visium Cassette.

See Visium Cassette section for more information. Some moisture remaining on the Visium CytAssist Spatial Gene Expression slide is normal.

- ac.** Proceed immediately to Probe & Antibody Tag Extension. CytAssist instrument should only be cleaned and data transferred at a safe stopping point.

5.2 Probe & Antibody Tag Extension

■ denotes volumes for 6.5 mm slides and ▲ denotes volumes for 11 mm slides.



- a. Add ■ **75 μ l** or ▲ **200 μ l** Probe and Antibody Tag Extension Mix to each well (only to A1 and D1 if using a 6.5 mm cassette). Gently tap Visium Cassette to ensure uniform coverage of Capture Area.

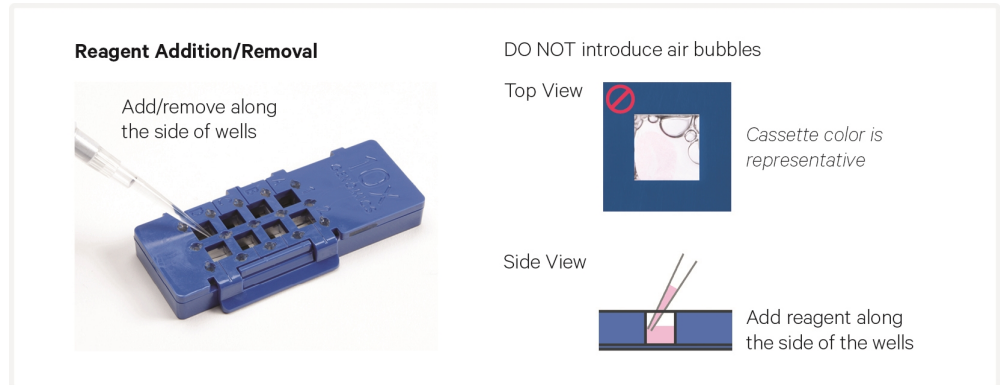

- b. Apply new uncut Visium Slide Seal on Visium Cassette and place on the Low Profile Thermocycler Adapter on pre-heated thermal cycler. Close thermal cycler lid.
- c. Skip Pre-equilibrate step to initiate Probe & Antibody Tag Extension .
-  d. Sample may remain at **4°C** in the thermal cycler for up to **2 h**. This is a safe stopping point to unload and clean the CytAssist instrument. Consult Visium CytAssist Instrument User Guide (CG000542) for more information.

5.3 Probe & Antibody Tag Elution

■ denotes volumes for 6.5 mm slides and ▲ denotes volumes for 11 mm slides.

- a. Prepare 0.08 M KOH Mix according to the appropriate table shortly before use, adding reagents in the order listed. Vortex and centrifuge briefly. Maintain at **room temperature**.



6.5 mm Slides					
KOH Mix	Stock	Final	1X (μl)	2X +10% (μl)	4X +10% (μl)
Nuclease-free Water	-	-	49.5	108.9	217.8
KOH	8 M	0.08 M	0.5	1.1	2.2
Total	-	-	50.0	110.0	220.0



11 mm Slides					
KOH Mix	Stock	Final	1X (μl)	2X +10% (μl)	4X +10% (μl)
Nuclease-free Water	-	-	198.0	435.6	871.2
KOH	8 M	0.08 M	2.0	4.4	8.8
Total	-	-	200.0	440.0	880.0

- b. Remove Visium Cassette from Low Profile Thermocycler Adapter and place on a flat, clean work surface after Probe Extension is complete.
- c. Remove Visium Slide Seal and using a pipette, remove all Probe and Antibody Tag Extension Mix from wells.
- d. Add ■ **100 μl** or ▲ **200 μl** 2X SSC Buffer prepared in [3.1 Post-Hybridization Wash on page 72](#) to each well (A1 and D1 if using a 6.5 mm cassette).
- e. Remove all 2X SSC Buffer from wells.
- f. Add ■ **50 μl** or ▲ **200 μl** 0.08 M KOH Mix to each well (A1 and D1 if using a 6.5 mm cassette). Gently tap the Visium Cassette to ensure uniform coverage of the Capture Area.
- g. Incubate at **room temperature** for **10 min**.
- h.  Transfer all solution for each sample containing the probes and antibody tags to a tube in an 8-tube strip if using a 6.5 mm cassette, or 1.5 ml microcentrifuge tube if using an 11 mm cassette. **DO NOT** leave behind any solution in the wells. See *Tips & Best Practices for reagent removal instructions*.

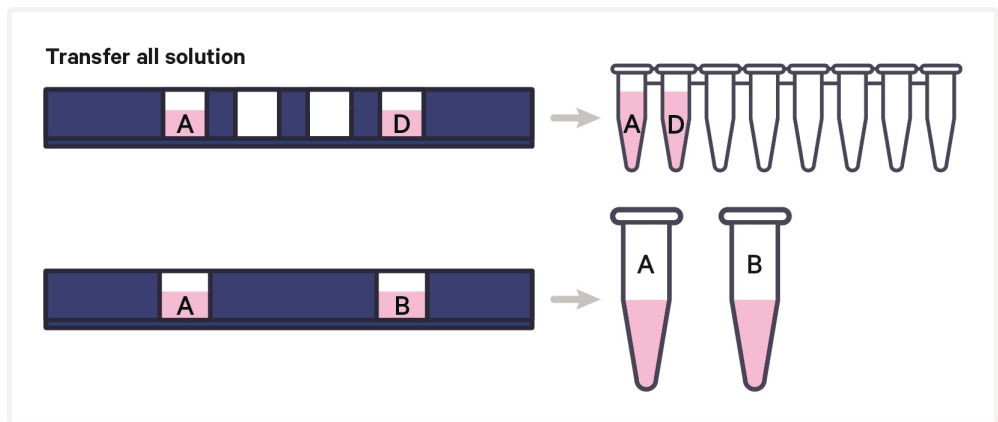

- i. Add ■ **3 μl** or ▲ **12 μl** 1 M Tris-HCl pH 8.0 to each sample. Vortex, centrifuge briefly, and place on ice. Failure to neutralize may result in a loss of signal and lower library complexity.
- j. If using 11 mm Slides, divide each **212 μl** neutralized sample among four tubes in an 8-tube strip so that each tube contains **53 μl** of the neutralized sample. If necessary, add enough nuclease-free water to arrive at the correct volume.

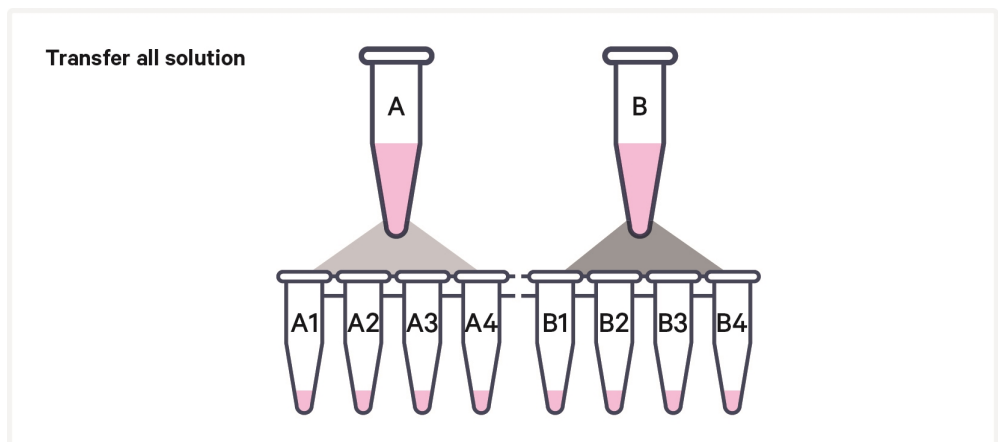

Step 6:



Pre-Amplification and SPRIselect

6.0 Get Started	102
6.1 Pre-Amplification	103
6.2 Pre-Amplification Cleanup - SPRIselect	105
6.3 Cycle Number Determination – qPCR	106



6.0 Get Started

Number of reactions in reagent preparation tables refers to the number of samples from Probe Elution.

Item	10x PN	Preparation & Handling	Storage
Equilibrate to room temperature			
<input type="checkbox"/> 	TS Primer Mix B Tube: 2000537 Kit: 1000436	Thaw at room temperature, vortex, and centrifuge briefly.	-20°C
<input type="checkbox"/> 	NT Primer Mix A Tube: 2000540 Kit: 1000603	Thaw at room temperature, vortex, and centrifuge briefly.	-20°C
<input type="checkbox"/>	Beckman Coulter SPRiselect Reagent -	Manufacturer's recommendations.	-
Place on ice			
<input type="checkbox"/> 	Amp Mix B Tube: 2000567 Kit: 1000436	Vortex, centrifuge briefly.	-20°C
Obtain			
<input type="checkbox"/>	Qiagen Buffer EB -		Ambient
<input type="checkbox"/>	10x Magnetic Separator Component: 230003 or 2000431 Kit: 1000499	See Tips & Best Practices.	Ambient
<input type="checkbox"/>	80% Ethanol -	Prepare fresh. Prepare 1 ml per reaction.	Ambient

6.1 Pre-Amplification



If working with samples from 11 mm slides, during Probe & Antibody Tag Elution, each 11 mm sample was split into four replicate tubes in an 8-tube strip. Thus, all reactions during pre-amplification will have four times the number tubes as Capture Areas.

- a. Prepare Pre-Amplification Mix on ice according to the appropriate table. Add reagents in the order listed. Pipette mix and centrifuge briefly. Maintain on ice.



6.5 mm Slides					
	Pre-Amplification Mix	PN	1X (μ l)	2X + 10% (μ l)	4X + 10% (μ l)
	Nuclease-free Water		17.0	37.4	74.8
○	Amp Mix B	2000567	25.0	55.0	110.0
●	TS Primer Mix B	2000537	2.5	5.5	11.0
●	NT Primer Mix A	2000540	2.5	5.5	11.0
	Total	-	47.0	103.4	206.8



11 mm Slides					
	Pre-Amplification Mix	PN	1X (μ l)	2X + 10% (μ l)	4X + 10% (μ l)
	Nuclease-free Water		68.0	149.6	299.2
○	Amp Mix B	2000567	100.0	220.0	440.0
●	TS Primer Mix B	2000537	10.0	22.0	44.0
●	NT Primer Mix A	2000540	10.0	22.0	44.0
	Total	-	188.0	413.6	827.2

- b. Add **47 μ l** Pre-Amplification Mix to each tube from [5.3 Probe & Antibody Tag Elution on page 99](#) (regardless of slide type). Pipette mix and centrifuge briefly.

c. Incubate in a thermal cycler with the following protocol.

Lid Temperature	Reaction Volume	Run Time
105°C	100 µl	~25 min
Step	Temperature	Time <i>hh:mm:ss</i>
1	98°C	00:03:00
2	98°C	00:00:15
3	63°C	00:00:20
4	72°C	00:00:30
5	Go to Step 2, repeat 9X for a total of 10 cycles	
6	72°C	00:01:00
7	4°C	Hold

6.2 Pre-Amplification Cleanup - SPRIselect

■ denotes volumes for samples from 6.5 mm slides and ▲ denotes volumes for samples from 11 mm slides.

If using MicroAmp 8-Tube Strips, use the high position (magnet•**High**) only throughout the protocol.

- a. Vortex to resuspend SPRIselect reagent. Add **120 µl** SPRIselect reagent (1.2X) to each pre-amplification reaction in an 8-tube strip (100 µl) and pipette mix 15x (pipette set to 175 µl).
- b. Incubate **5 min** at **room temperature**.
- c. Place on the magnet•**High** until solution clears.
- d. Remove supernatant.
- e. Add **300 µl** 80% ethanol to pellet. Wait **30 sec**. Pipette carefully as **300 µl** is at tube limit.
- f. Remove ethanol.
- g. Add **200 µl** 80% ethanol to pellet. Wait **30 sec**.
- h. Remove ethanol.
- i. Centrifuge briefly and place on magnet•**Low**.
- j. Remove any remaining ethanol without disturbing the beads. Air dry for **2 min**. DO NOT exceed **2 min** as this will decrease elution efficiency.
- k. Remove from magnet. Add ■ **105 µl** or ▲ **27.5 µl** Buffer EB. Pipette mix 15x (pipette set to 100 µl for samples from 6.5 mm slides or 25 µl for samples from 11 mm slides).
- l. Incubate **2 min** at **room temperature**.
- m. Place tube strip on magnet •**High** for samples from 6.5 mm slides or •**Low** for samples from 11 mm slides until solution clears.
- n. For samples from 6.5 mm slides, transfer **100 µl** sample to a new tube strip.

For samples from 11 mm slides, pool replicate samples together (Four **25 µl** samples for a total of **100 µl** per Capture Area), vortex and centrifuge briefly.
- o. Store at **4°C** for up to **72 h**, **-20°C** for up to **4 weeks**, or proceed to next step.



After this point in the protocol, all instructions are the same regardless of slide type used.

6.3 Cycle Number Determination – qPCR

- a. Dilute TS Primer Mix B and NT Primer Mix A 1:10 in nuclease-free water. The amount of diluted primer mix required to generate the qPCR mixes is described in the table below.
- b. Prepare **separate** qPCR Mixes on ice according to the tables below. Add reagents in the order listed. Vortex and centrifuge briefly. Maintain on ice.
A passive reference dye, such as ROX, may be required. Consult the Roche KAPA SYBR FAST qPCR Kit website or the appropriate qPCR system manufacturer for guidance.

Gene Expression qPCR Mix	Stock	Final	1X (μl)	3X* + 10% (μl)	5X* + 10% (μl)
KAPA SYBR FAST qPCR Master Mix Minimize light exposure	2X	1X	5.0	16.5	27.5
Diluted TS Primer Mix B	-	-	1.0	3.3	5.5
Nuclease-free Water	-	-	3.0	9.9	16.5
Total			9.0	29.7	49.5

*Includes one negative control

Protein Expression qPCR Mix	Stock	Final	1X (μl)	3X* + 10% (μl)	5X* + 10% (μl)
KAPA SYBR FAST qPCR Master Mix Minimize light exposure	2X	1X	5.0	16.5	27.5
Diluted NT Primer Mix A	-	-	1.0	3.3	5.5
Nuclease-free Water	-	-	3.0	9.9	16.5
Total			9.0	29.7	49.5

*Includes 1 negative control

- c. Add **9 μl** qPCR Mix to one well per sample in a qPCR plate (a well for negative control may be included).
- d. Add **9 μl** Protein Expression qPCR Mix to one well per sample in a qPCR plate (a well for negative control may be included).
- e. Dilute **2 μl** sample from Pre-Amplification Cleanup - SPRIselect in **8 μl** nuclease-free water. Pipette mix, centrifuge briefly.
- f. Transfer **1 μl** diluted sample from Pre-Amplification Cleanup - SPRIselect to each qPCR plate well containing qPCR Mix. For the negative control, add **1 μl** nuclease-free water to the corresponding well. Pipette mix.

- g. Apply seal and centrifuge briefly. Record which sample is in which well (as well as whether the well contained Gene Expression or Protein Expression qPCR mix) of the qPCR plate.

Only **25 µl** of pre-amplification material is used to generate gene expression libraries, while **25 µl** of pre-amplification material is used to generate protein expression libraries. The remaining **50 µl** (50%) can be stored at **4°C** for up to **72 h** or at **-20°C** for up to **4 weeks** for generating additional libraries.

- h. Prepare a qPCR system with the following protocol, place the plate in the thermal cycler, and start the program.

Lid Temperature	Reaction Volume	Run Time
105°C	10 µl	35 min

Step	Temperature	Time hh:mm:ss
1	98°C	00:03:00
2	98°C	00:00:05
3	63°C	00:00:30

 Read signal

4	Go to step 2, 29x (total of 30 cycles)	-
---	--	---

- i. Record the Cq value for each sample.

Set the y-axis to a linear scale. Plot RFU on the y-axis if not using a reference dye, or ΔRn if using a reference dye. The threshold for determining the Cq value should be set along the exponential phase of the amplification plot, at ~25% of the peak fluorescence value.

If the Cq value is > 20 cycles, refer to [Troubleshooting on page 131](#) or contact support@10xgenomics.com before proceeding.

Representative qPCR Amplification Plots

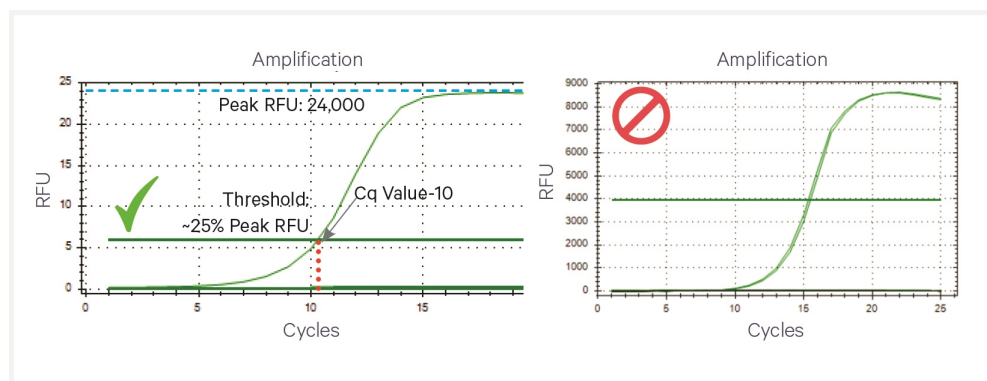

In this User Guide, Visium CytAssist Spatial Gene Expression - Probe-based libraries are constructed before Visium CytAssist Spatial Protein

Expression libraries. If constructing both library types simultaneously, consider that each library preparation may require a separate thermal cycler for sample index PCR due to differences in the required number of cycles between the libraries, as determined by the current step. Separate dual index plates are also required.

If constructing Visium CytAssist Spatial Protein Expression libraries later, store unused pre-amplification material until ready to perform protein expression library construction.

Step 7:

Visium CytAssist Spatial Gene Expression – Probe-based Library Construction

7.0 Get Started	110
7.1 GEX Sample Index PCR	111
7.2 GEX Post-Sample Index PCR Cleanup – SPRIselect	113
7.3 GEX Post-Library Construction QC	114



7.0 Get Started

Item	10x PN	Preparation & Handling	Storage	
Equilibrate to room temperature				
<input type="checkbox"/>	Dual Index Plate TS Set A	Tube: 3000511 Kit: 1000251	Thaw at room temperature, vortex, and centrifuge briefly.	-20°C
<input type="checkbox"/>	Beckman Coulter SPRiselect Reagent	-	Manufacturer's recommendations.	-
<input type="checkbox"/>	Agilent TapeStation Screen Tape and Reagents If used for QC	-	Manufacturer's recommendations.	-
<input type="checkbox"/>	Agilent Bioanalyzer High Sensitivity DNA kit If used for QC	-	Manufacturer's recommendations.	-
Place on ice				
<input type="checkbox"/>	<input type="radio"/> Amp Mix B	Component: 2000567 Kit: 1000436	Vortex, centrifuge briefly. Maintain on ice.	-20°C
<input type="checkbox"/>	KAPA SYBR Fast qPCR Master Mix	-	Manufacturer's recommendations.	-
Obtain				
<input type="checkbox"/>	Nuclease-free Water	-	-	Ambient
<input type="checkbox"/>	Qiagen Buffer EB	-	-	Ambient
<input type="checkbox"/>	10x Magnetic Separator	Component: 230003 or 2000431 Kit: 1000499	See Tips & Best Practices.	Ambient
<input type="checkbox"/>	80% Ethanol	-	Prepare fresh. Prepare 400 µl per reaction.	Ambient

7.1 GEX Sample Index PCR



- a. Choose the appropriate sample index sets to ensure that no sample indices overlap in a multiplexed sequencing run. Record the 10x Sample Index name (PN-3000511 Plate TS Set A well ID) used.
- b. Prepare Amplification Master Mix and pipette mix 10x shortly before use.

	Amplification Master Mix	10x PN	1X (μl)	2X +10% (μl)	4X +10% (μl)
	Nuclease-free Water	-	45	99	198
○	Amp Mix B	2000567	25	55	110
	Total	-	70	154	308

- c. Add **70 μl** Amplification Master Mix to a tube in an 8-tube strip for each sample.
- d. Add **25 μl** of each sample from pre-amplification to a separate tube previously aliquoted with Amplification Master Mix.
- e. Add **5 μl** of an individual Dual Index TS Set A to each tube and record the well ID used. Pipette mix and centrifuge briefly.
- f. Incubate in a thermal cycler with the following protocol.

Lid Temperature	Reaction Volume	Run Time
105°C	100 μl	Variable
Step	Temperature	Time hh:mm:ss
1	98°C	00:03:00
2	98°C	00:00:15
3	63°C	00:00:20
4	72°C	00:00:30
5	Go to step 2, use the Cq Value +2 as the total # of cycles. See table below for total # of cycle examples.	
6	72°C	00:01:00
7	4°C	Hold

Round Cq values up to the nearest whole number and add two cycles (examples below). Samples within ± 1 cycle numbers can be combined in a single SI-PCR run at the higher cycle number.



Do not combine samples if the cycle number difference is greater than 1 to avoid library overamplification.

Example Cycle Numbers

Cq Value from qPCR	+2	Total Cycles
7.2	+2	10
8.5	+2	11
13.7	+2	16



Any remaining pre-amplification material can be stored at **4°C** for up to **72 h** or at **-20°C** for up to **4 weeks** for generating additional libraries.

7.2 GEX Post-Sample Index PCR Cleanup – SPRIselect

If using MicroAmp 8-Tube Strips, use the high position (magnet•**High**) only throughout the protocol

- a. Vortex to resuspend SPRIselect Reagent. Add **85 µl** SPRIselect Reagent (**0.85X**) to each sample. Pipette mix 15x (pipette set to 175 µl).
- b. Incubate **5 min** at **room temperature**.
- c. Place on magnet•**High** until solution clears.
- d. Remove supernatant.
- e. Add **200 µl** 80% ethanol to pellet. Wait **30 sec**.
- f. Remove ethanol.
- g. **Repeat** steps e and f for a total of two washes.
- h. Centrifuge briefly. Place on the magnet•**Low**.
- i. Remove any remaining ethanol. Air dry for **2 min**. DO NOT exceed **2 min** as this will decrease elution efficiency.
- j. Remove from magnet. Add **27 µl** Buffer EB. Pipette mix 15x.
- k. Incubate **2 min** at **room temperature**.
 - l. Place on the magnet•**Low** until solution clears.
- m. Transfer **25 µl** sample to a new tube strip.
- n. Store at **-20°C** for **long-term** storage.



7.3 GEX Post-Library Construction QC

- a. Dilute sample (1:50 dilution, i.e **1 μ l** sample in **49 μ l** of EB buffer) until it is at an appropriate concentration for the Bioanalyzer.
- b. Run **1 μ l** of sample on an Agilent Bioanalyzer High Sensitivity chip. If peak is too small or flat, retry with a lower dilution. See [Troubleshooting on page 131](#) for more information.

Representative Trace

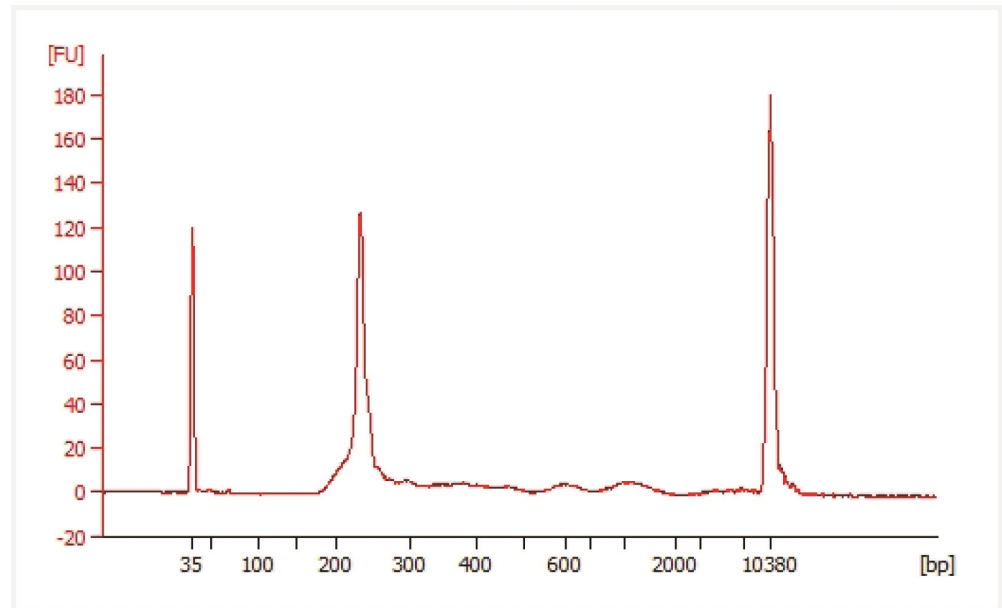

Determine the average fragment size from the Bioanalyzer trace. The expected average fragment size is 240 bp. This will be used as the insert size for library quantification.

Alternate QC Methods:

- Agilent TapeStation
- LabChip

See [Appendix on page 144](#) for representative traces

See [Post Library Construction Quantification on page 145](#)

Step 8:

Visium CytAssist Spatial Protein Expression Library Construction

8.0 Get Started	116
8.1 Protein Sample Index PCR	117
8.2 Protein Post-Sample Index PCR Cleanup – SPRiselect	119
8.3 Protein Post-Library Construction QC	120



8.0 Get Started

Item	10x PN	Preparation & Handling	Storage	
Equilibrate to room temperature				
<input type="checkbox"/>	Dual Index Plate NT Set A	Component: 3000483 Kit: 1000242	Thaw at room temperature, vortex, and centrifuge briefly.	-20°C
<input type="checkbox"/>	Beckman Coulter SPRiselect Reagent	-	Manufacturer's recommendations.	-
<input type="checkbox"/>	Agilent TapeStation Screen Tape and Reagents If used for QC	-	Manufacturer's recommendations.	-
<input type="checkbox"/>	Agilent Bioanalyzer High Sensitivity DNA kit If used for QC	-	Manufacturer's recommendations.	-
Place on ice				
<input type="checkbox"/>	<input type="radio"/> Amp Mix B	Tube: 2000567 Kit: 1000436	Vortex, centrifuge briefly.	-20°C
Obtain				
<input type="checkbox"/>	Nuclease-free Water	-	-	Ambient
<input type="checkbox"/>	Qiagen Buffer EB	-	-	Ambient
<input type="checkbox"/>	10x Magnetic Separator	Component: 230003 or 2000431 Kit: 1000499	See Tips & Best Practices.	Ambient
<input type="checkbox"/>	80% Ethanol	-	Prepare fresh.	Ambient

8.1 Protein Sample Index PCR



- a. Choose the appropriate sample index sets to ensure that no sample indices overlap in a multiplexed sequencing run. Record the 10x Sample Index name (PN-1000242 Dual Index Plate NT Set A) used.
- b. Prepare Amplification Master Mix and pipette mix 10x shortly before use.

	Amplification Master Mix	10x PN	1X (μl)	2X +10% (μl)	4X +10% (μl)
	Nuclease-free Water	-	45	99	198
○	Amp Mix B	2000567	25	55	110
	Total	-	70	154	308

- c. Add **70 μl** Amplification Master Mix to a tube in an 8-tube strip for each sample.
- d. Add **25 μl** of each sample from pre-amplification to a separate tube previously aliquotted with Amplification Master Mix.
- e. Add **5 μl** of an individual Dual Index Plate NT Set A (PN-3000483) to each tube and record the well ID used. Pipette mix and centrifuge briefly.
- f. Incubate in a thermal cycler with the following protocol.

Lid Temperature	Reaction Volume	Run Time
105°C	100 μl	~25-40 min
Step	Temperature	Time hh:mm:ss
1	98°C	00:03:00
2	98°C	00:00:15
3	63°C	00:00:20
4	72°C	00:00:30
5	Go to step 2, use the Cq Value +2 as the total # of cycles. See table below for total # of cycle examples.	
6	72°C	00:01:00
7	4°C	Hold

Round Cq values to the nearest whole number and add two cycles, as shown in the examples below.

Example Cycle Numbers

Cq Value from qPCR	+2	Total Cycles
12.2	+2	15
13.5	+2	16
19.7	+2	22

8.2 Protein Post-Sample Index PCR Cleanup – SPRIselect

If using MicroAmp 8-Tube Strips, use the high position (magnet•**High**) only throughout the protocol

- a. Vortex to resuspend SPRIselect Reagent. Add **85 µl** SPRIselect Reagent (**0.85X**) to each sample. Pipette mix 15x (pipette set to 175 µl).
- b. Incubate **5 min** at **room temperature**.
- c. Place on the magnet•**High** until the solution clears.
- d. Remove the supernatant.
- e. With the tube still in the magnet, add **200 µl** 80% ethanol to the pellet. Wait **30 sec**.
- f. Remove the ethanol.
- g. **Repeat** steps e and f for a total of two washes.
- h. Centrifuge briefly. Place on the magnet•**Low**.
- i. Remove any remaining ethanol. Air dry for **2 min**. DO NOT exceed **2 min** as this will decrease elution efficiency.
- j. Remove from the magnet. Add **27 µl** Buffer EB. Pipette mix 15x.
- k. Incubate **2 min** at **room temperature**.
- l. Place on the magnet•**Low** until the solution clears.
- m. Transfer **25 µl** sample to a new tube strip.
- n. Store at **-20°C** for **long-term** storage.

8.3 Protein Post-Library Construction QC

- a. Quantify library using a Nanodrop or Qubit Fluorometer.
- b. Dilute sample (1:50 dilution, i.e **1 μ l** sample in **49 μ l** of solution) until it is at an appropriate concentration for the Bioanalyzer
- c. Run **1 μ l** of sample on an Agilent Bioanalyzer High Sensitivity chip.

Representative Trace

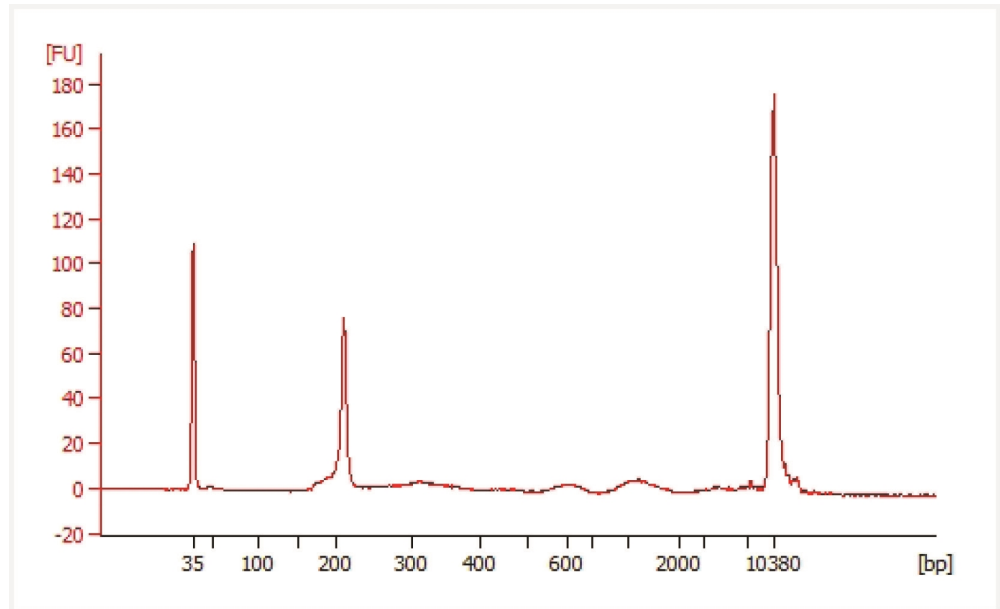

Determine the average fragment size from the Bioanalyzer trace. The expected average fragment size is 210 bp. This will be used as the insert size for library quantification.

Alternate QC Method:

- Agilent TapeStation
- LabChip

See [Appendix on page 144](#) for representative traces

See [Post Library Construction Quantification on page 145](#)

Sequencing

Sequencing Libraries	122
Sequencing Depth	123
Sequencing Type & Run Parameters	125
Illumina Sequencer Compatibility	125
Sample Indices	125
Library Loading	126
Library Pooling	126
Sequencing Metrics	127

Sequencing Libraries

Libraries contain standard Illumina paired-end constructs, which begin with P5 and end with P7. 16 bp Spatial Barcodes are encoded at the start of TruSeq Read 1 (Read 1T) and Nextera Read 1 (Read 1N) respectively, while i7 and i5 sample index sequences are incorporated as the index read. Read 1T, TruSeq Read 2 (Read 2T), Read 1N, and Small RNA Read 2 (Read 2S) are standard Illumina sequencing primer sites used in paired-end sequencing. Read 1T and Read 1N are used to sequence the 16 bp Spatial Barcode and 12 bp UMI. Read 2S is used to sequence the Ligated Probe Insert. Read 2T is used to sequence the antibody barcode. Sequencing these libraries produces a standard Illumina BCL data output folder.

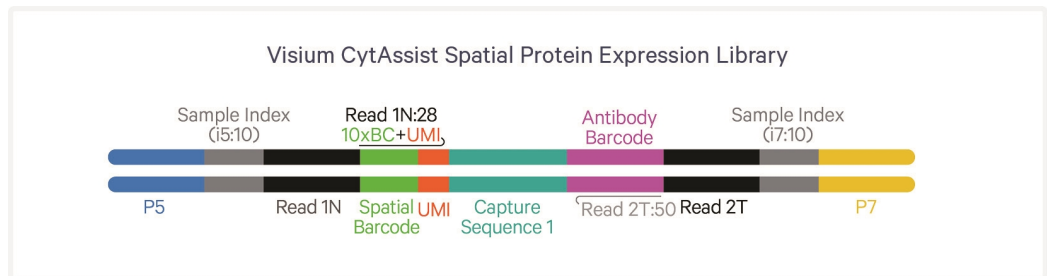
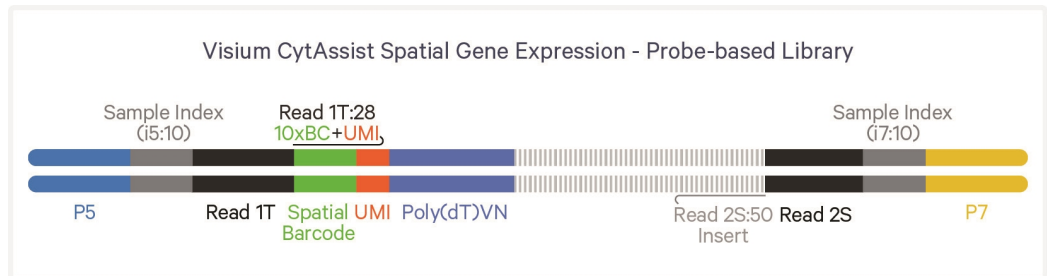

Sequencing Depth

Calculating sequencing depth requires estimating the approximate Capture Area (%) covered by tissue. This may be performed visually or by using the Visium Manual Alignment Wizard in Loupe Browser for a more accurate measurement. See examples below for estimating coverage area visually. If using Loupe Browser, the number of spots covered by tissue will be displayed during the “Identify Tissue” step. For more information, consult the 10x Genomics Support website.

The examples below are for 6.5 mm slides. The total number of spots/Capture Area should be adjusted based on the Capture Area size (the number of spots for 6.5 mm slides is 4,992 and the number of 11 mm slides is 14,336).

Sequencing Depth for Visium CytAssist Spatial Gene Expression – Probe-based libraries:

Sequencing Depth/spot

Minimum 25,000 read pairs per tissue covered spot on Capture Area

Sequencing Depth/sample

See example calculation below

Example: Sequencing Depth for a Sample

- **Estimate the approximate Capture Area (%)** covered by the tissue section.
- **Calculate total sequencing depth=**
(Coverage Area x total spots on the Capture Area)
x 25,000 read pairs/spot
- **Example calculation for 60% coverage:**
(0.60 x 5,000 total spots) x 25,000 read pairs/spot=
75 million total read pairs for that sample

Estimated Coverage Area (%) Examples

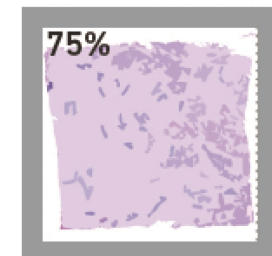
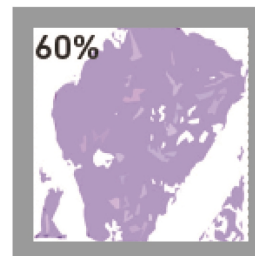
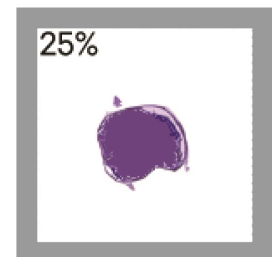
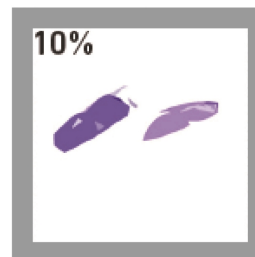

Sequencing Depth for Visium CytAssist Spatial Protein Expression libraries:

Sequencing Depth/spot

Minimum 5,000 read pairs per tissue covered spot on Capture Area

Sequencing Depth/sample

See example calculation below

Example: Sequencing Depth for a Sample

- Estimate the approximate Capture Area (%)**
 covered by the tissue section.
- Calculate total sequencing depth=**
 (Coverage Area x total spots on the Capture Area)
 x 5,000 read pairs/spot
- Example calculation for 60% coverage:**
 (0.60 x 5,000 total spots) x 5,000 read pairs/spot=
 15 million total read pairs for that sample

Estimated Coverage Area (%) Examples

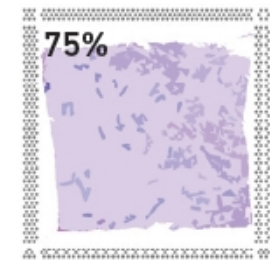
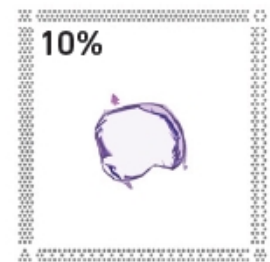

Sequencing Type & Run Parameters

Use the sequencing run type and parameters indicated.

Visium CytAssist Spatial Gene Expression - Probe-based Library

Paired-end, dual indexed sequencing

Read 1: 28 cycles
i7 Index: 10 cycles
i5 Index: 10 cycles
Read 2S: 50 cycles*

Visium CytAssist Spatial Protein Expression Library

Paired-end, dual indexed sequencing

Read 1: 28 cycles
i7 Index: 10 cycles
i5 Index: 10 cycles
Read 2S: 50 cycles

Visium CytAssist Spatial Gene Expression - Probe-based libraries may be pooled for sequencing, taking into account the differences in tissue covered spot on a Capture Area and per-spot read depth requirements between each library. Samples utilizing the same sample index should not be pooled together, or run on the same flow cell lane, as this would not enable correct sample demultiplexing.

Illumina Sequencer Compatibility

Libraries generated from this User Guide are compatible with the following sequencers. Some variation in assay performance is expected based on sequencer choice. Data from tested sequencers are shown in [Sequencing Metrics on page 127](#).

- MiSeq
- NextSeq 500/550
- NextSeq 1000/2000
- NovaSeq 6000
- iSeq

Sample Indices

Each well of the Dual Index Kit TS and NT Set A (PN-1000251 and PN-1000242) contains a mix of one unique i7 and one unique i5 sample index. If multiple samples are pooled in a sequence lane, the sample index name (i.e. the Dual Index TS Set A plate well ID, SI-TS-) is needed in the sample sheet

used for generating FASTQs with “spaceranger mkfastq”. Samples utilizing the same sample index should not be pooled together or run on the same flow cell lane, as this would not enable correct sample demultiplexing.

Library Loading

Library quantification should be done with the KAPA DNA Quantification Kit using the average insert size determined by Agilent Bioanalyzer, Perkin Elmer LabChip, or Agilent Tapestation QC. Alternate methods to KAPA qPCR for final library concentration may result in underquantification and consequently overloading.

Once quantified and normalized, libraries should be denatured and diluted as recommended for Illumina sequencing platforms. Consult Illumina documentation for denaturing and diluting libraries.

Instrument	Loading Concentration (pM)	PhiX (%)
MiSeq	11	1
NextSeq 500/550	1.8	1
NextSeq 1000/2000	650	1
NovaSeq 6000 Standard	100-150	1
NovaSeq 6000 XP Workflow	150-200	1
iSeq	150	1

Library Pooling

Visium CytAssist Spatial Gene Expression – Probe-based libraries and Protein Expression libraries should be pooled for sequencing, taking into account differences in tissue covered spot on a Capture Area and per-spot read depth requirements between each library. Samples using the same sample index should not be pooled together, or run on the same flow cell lane, as this would not enable correct sample demultiplexing.

Library Pooling Example

Libraries	Sequencing Depth (read pairs per tissue-covered spot)	Library Pooling Ratio
Visium CytAssist Spatial Gene Expression – Probe-based	25,000	5
Visium CytAssist Spatial Protein Expression	5,000	1

Sequencing Metrics

To compare sequencing metrics across Illumina platforms, Visium CytAssist Spatial Gene Expression - Probe-based and Visium CytAssist Spatial Protein Expression libraries were generated from two Hematoxylin & Eosin (H&E) stained human tonsil tissue samples. Samples were processed according to documentation listed in the [Workflow Overview](#). Libraries were pooled and sequenced at the indicated run parameters to generate the % Base and % \geq Q30 plots shown in the following figures. These same libraries were used to illustrate sequence compatibility. All libraries were quantified with the KAPA DNA Quantification Kit and sequenced with 1% PhiX. All libraries followed the following sequencing configuration and run parameters:

- Targeted sequencing depth: 25,000 read pairs per tissue-covered spot (Probe-based libraries) or 5,000 read pairs per tissue-covered spot (Protein Expression libraries).
- Paired-end, dual indexing: Read 1: 28 cycles; i7 Index: 10 cycles; i5 Index: 10 cycles; Read 2: 50 cycles

% Base by cycle and % \geq Q30 Quality Score distribution showed highly consistent profiles for all sequencing platforms tested. The data serve as guidelines for assessing the quality of library sequencing. Additional factors that may contribute to overall success of a sequencing run and impact downstream application performance metrics include:

- Starting with a high-quality tissue block.
- Generating sequencing data from sections that remain adhered to the slide.
- Final libraries with fragment lengths within the expected size range for each library type.
- Reliable and accurate library quantification using the KAPA qPCR DNA Quantification Kit for Illumina Platforms (Roche, KK4824) and the average insert size determined by Agilent Bioanalyzer, Perkin Elmer LabChip, or Agilent TapeStation QC. Alternative methods to KAPA qPCR, such as Qubit, for final library quantification may result in underquantification and result in overloading flow cells.
- Sequencing platform loading concentrations follow recommendations described in [Library Loading on the previous page](#), which are based on KAPA qPCR quantification. Overloading/over-clustering may result in poor run performance, decrease sequencing quality, and lower total data output as compared to optimally loaded runs. The loading recommendations for an individual sequencer are listed as general guidance and additional optimization may be required.

Probe-based Libraries Pooled with Protein Expression Libraries

Representative % Base and % ≥Q30 plots are from a pool of two Probe-based and two Protein Expression libraries sequenced on a NovaSeq SP flow cell.

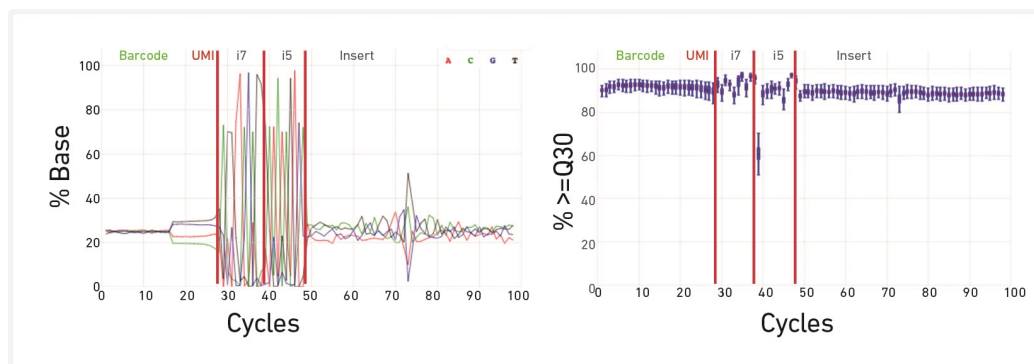

Libraries were sequenced on the indicated Illumina sequencers. "Data by Cycle" plots from the Illumina SAV software displaying the percentage of base calls and Q30 quality scores are shown. Mapped Reads (%) refers to Reads Mapped Confidently to Probe Set for Probe-based (GEX) libraries. Mapped Reads (%) refers to Fraction Antibody Reads for Protein Expression (PEX) libraries.

Instr.	Load Conc. (pM)	Cluster Density (K/mm ²)	%PF	R1	R2	R1	i7	i5	R2	GEX	PEX
				Yield per Lane (Gb)		% ≥Q30				Mapped Reads (%)	
NextSeq 500	1.6	119	96.62	2.01	3.66	98.50	97.34	98.31	96.98	97.0	96.4
NextSeq 2000	650	4,974	78.10	14.06	25.51	96.47	95.16	94.95	96.29	97.2	96.4
NovaSeq 6000	300	2,961	82.72	13.29	24.10	91.60	92.98	87.45	88.81	96.2	96.3

Probe-based Libraries Alone

Representative % Base and % ≥Q30 plots are from a pool of two Probe-based libraries sequenced on a NovaSeq SP flow cell.

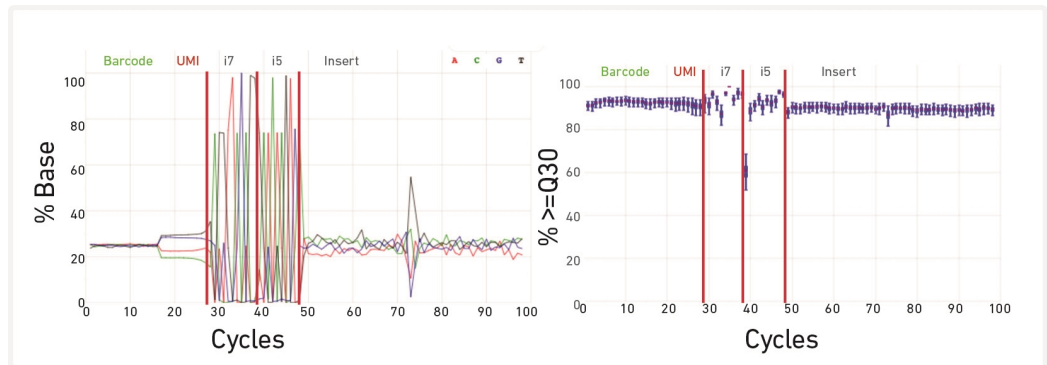

Libraries were sequenced on the indicated Illumina sequencers. "Data by Cycle" plots from the Illumina SAV software displaying the percentage of base calls and Q30 quality scores are shown. Mapped Reads (%) refers to Reads Mapped Confidently to Probe Set for Probe-based (GEX).

Instr.	Load Conc. (pM)	Cluster Density (K/mm ²)	%PF	R1	R2	R1	i7	i5	R2	GEX
				Yield per Lane (Gb)		% ≥Q30				Mapped Reads (%)
NextSeq 500	1.6	120.75	97.00	2.05	3.72	98.49	97.53	94.66	96.98	96.9
NovaSeq 6000	300	2,961	83.42	13.37	24.25	92.27	94.19	88.84	89.48	96.4

Protein Expression Libraries Alone

Representative % Base and % ≥Q30 plots are from a pool of two Protein Expression libraries sequenced on a NovaSeq SP flow cell.

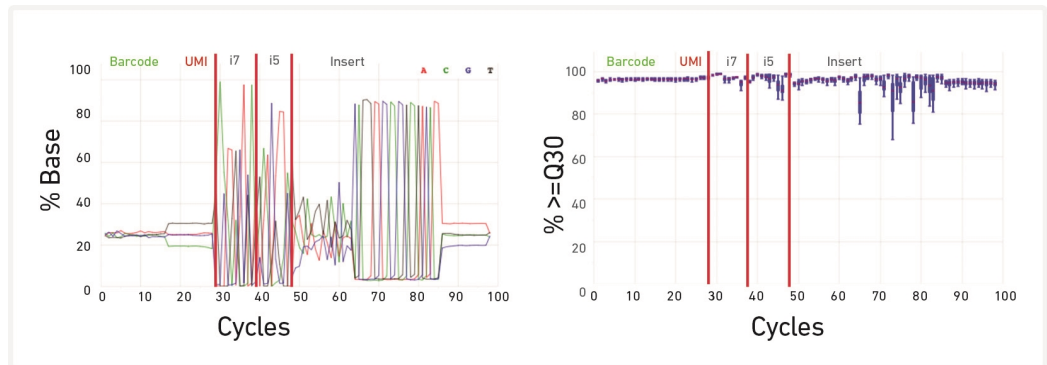

Libraries were sequenced on the indicated Illumina sequencers. "Data by Cycle" plots from the Illumina SAV software displaying the percentage of base calls and Q30 quality scores are shown. Mapped Reads (%) refers to Fraction Antibody Reads for Protein Expression (PEX) libraries.

Instr.	Load Conc. (pM)	Cluster Density (K/mm ²)	%PF	R1	R2	R1	i7	i5	R2	PEX
				Yield per Lane (Gb)		% ≥Q30				Mapped Reads (%)
NextSeq 2000	650	4,974	80	3.46	6.29	96.36	97.22	96.52	94.69	96.4

Troubleshooting



Before CytAssist Instrument Run

1. Bubbles during Coverslipping

A bubble could be generated during coverslipping.

Bubbles may cause blackening of tissue

H&E Stain

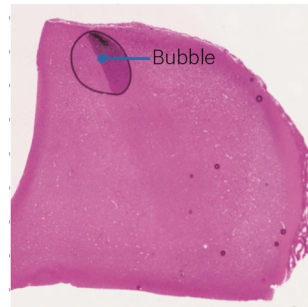

A bubble could be generated during coverslipping. Avoid generating bubbles during mounting medium dispensing by pipetting slowly and avoiding expelling air from the pipette tip. If the bubble is on the tissue, blackening of the tissue could occur. However, this does not diminish sensitivity and spatial resolution, and the data derived from the blackened area can still be analyzed.

2. Tissue Thickness Outside of Specifications

FFPE tissue sections should be between 3 and 10 μm . Sections outside these specifications may result in reduced performance. Mouse sections shown below are for demonstration purposes only. Mouse tissues are not supported for this application.

Thin Sections May Lead to Decreased Sensitivity

H&E Stained Tissue at Recommended Thickness

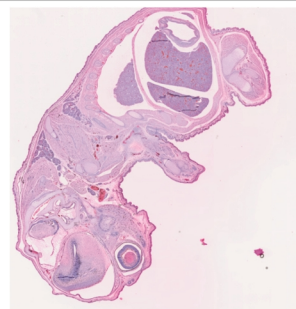

H&E Stained Tissue Below Recommended

Mean Panel UMI Count at 20,000 Raw Reads per Spot: 14,645

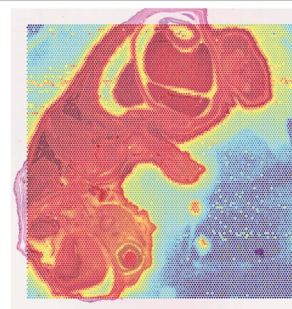

Mean Panel UMI Count at 20,000 Raw Reads per

Thin Sections May Lead to Decreased Sensitivity

Thickness

Spot: 8,511

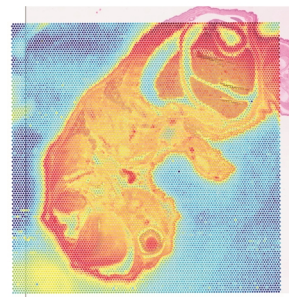
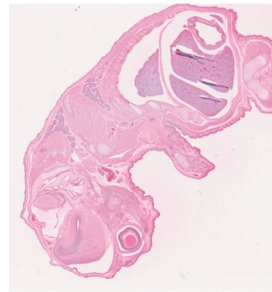

3. Incorrect Thermal Cycler Ramp Rate

Incorrect thermal cycler ramp rates negatively impact assay sensitivity (mean UMI counts and mean genes per tissue-covered spot), but has no impact on assay quality (reads mapped confidently to the probe set). These data show that using a Biometra TAdvanced thermal cycler at the incorrect ramp rate (8°C/sec heating and cooling) vs. the correct ramp rate (2°C/sec heating and cooling) negatively impacts assay sensitivity. Use the recommended ramp rates as described in [Recommended Thermal Cyclers on page 14](#).

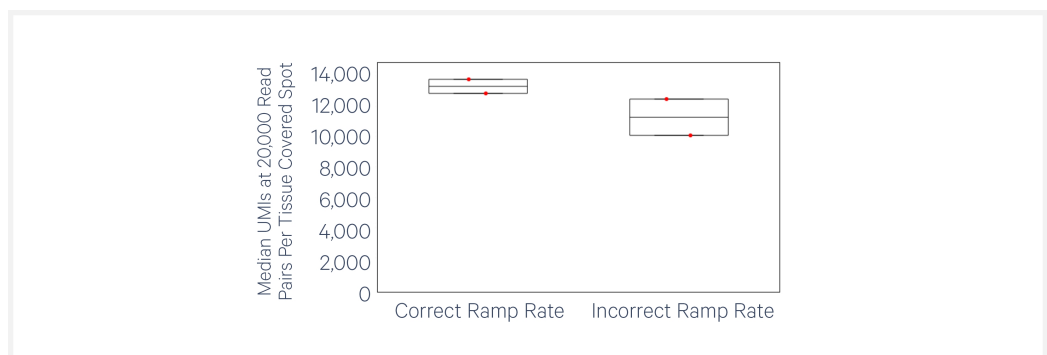
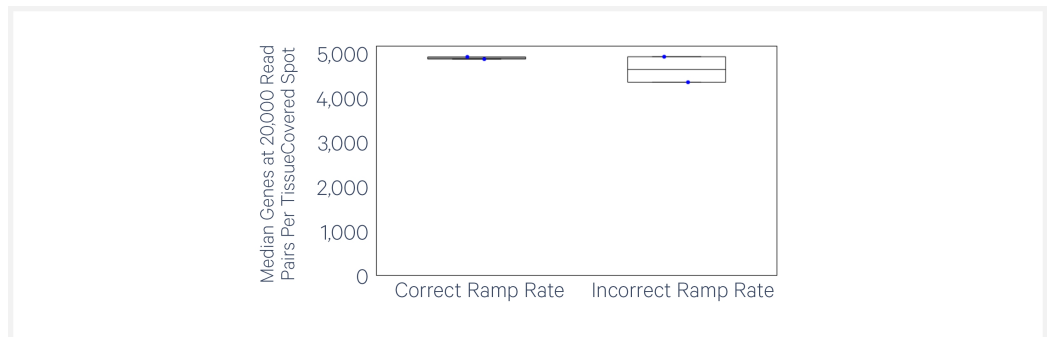



4. Number of Washes

Post hybridization and post ligation washes are critical for assay performance. Failure to perform the correct number of washes can reduce the fraction of targeted reads usable (see table below). A similar effect is observed when washing for less than the recommended 5 min, or when reagent is carried over during the washes. Remove all liquid from the well when washing, and refer to User Guide for correct number of washes and incubation times.

Wash	Number of Washes	Fraction Reads Usable (Mean)
Post Hybridization Wash	1	0.29
	2	0.41
	3	0.79
Post Ligation Washes	1	0.69
	2	0.75

5. High Signal Spots in Tissue Section

Areas of High Signal Intensity in Tissue Section

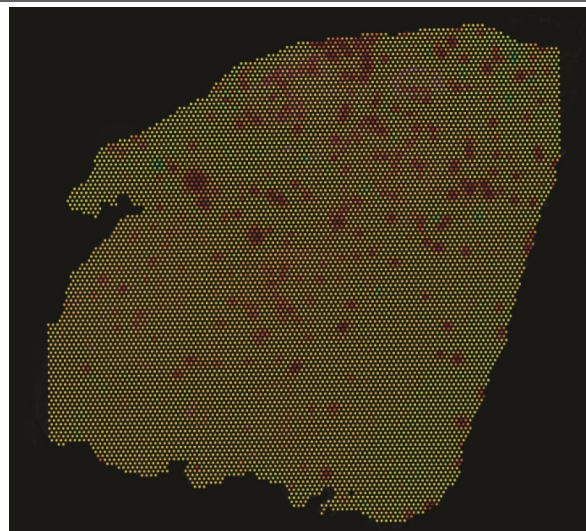

Areas of high signal intensity that do not align with tissue morphology, show in the same areas across several antibodies, and are not consistent between replicates are indicative of antibody aggregates. Ensure that the antibody mix is properly centrifuged. Do not touch the bottom of the tube when removing the antibody mix.

6. Incorrect Visium Slide Loading

Loading the Visium Slide incorrectly onto the Visium Slide Stage may result in slide breakage. Ensure that the slide sits within the grooves of the Visium Slide Stage, with the label facing toward the right. The images below show the Visium Slide loaded correctly and incorrectly.

Visium Slide Stage is Loaded Correctly with One Slide



Slide fits inside the grooves.
Label on the right is partially obscured by the lock.
Capture areas line up with alignment windows.

INCORRECT

Slide does not fit inside the grooves.
Capture areas do not line up with alignment windows.

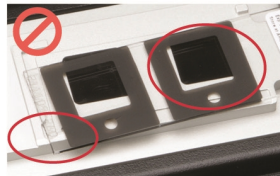

INCORRECT

Label is on the left.
Capture areas do not line up with alignment windows.



Slide is Broken due to Improper Loading

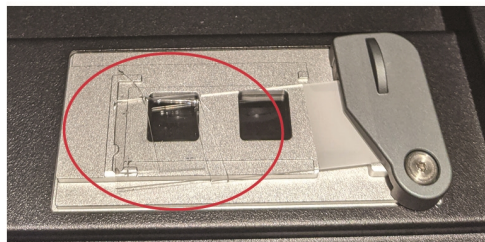

In the event of slide breakage, remove all traces of broken glass to avoid damaging the instrument. Exercise caution when removing glass to prevent injury.

During CytAssist Instrument Run

1. Bubbles Trapped During Visium CytAssist Run

Bubbles may Result in no Usable Sequencing Reads during the CytAssist Assay

Eosin Stained Tissue

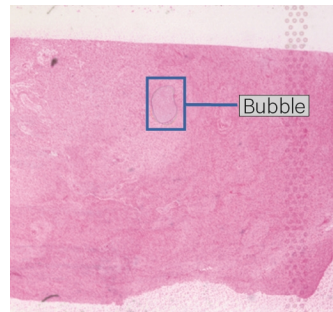

UMI Counts

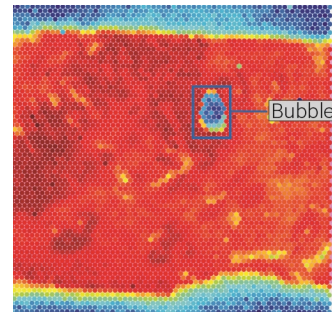

Some eosin may be washed off during an instrument run, as shown on the right side of this image. This does not affect performance.

Bubbles during a sample run are rare, but may result in a lack of useable reads in the tissue area where the bubbled occurred. Avoid generating bubbles during reagent dispensing by pipetting slowly and avoiding expelling air from the pipette tip. Additionally, ensure that the frosted area of the tissue slides are outside of the alignment guide lines on the Tissue Slide Stage and that tissue slides are compatible with the CytAssist instrument.

2. Reagent Flow Failure

Inappropriate flow of reagents during a Visium CytAssist experiment run may result in transcript mislocation. If UMI map appears abnormal (>50% of UMIs outside of tissue), contact support@10xgenomics.com.

Ensure that frosted areas of the tissue slide are not within the dashed zone on the Visium Tissue Slide Stage. Keep Visium slides and tissue slides free from physical damage, dust, and debris. After Eosin wash, remove as much PBS as possible by flicking the tissue slide and wiping any remaining droplets around tissue with a laboratory wipe.

3. Visium CytAssist Overheating

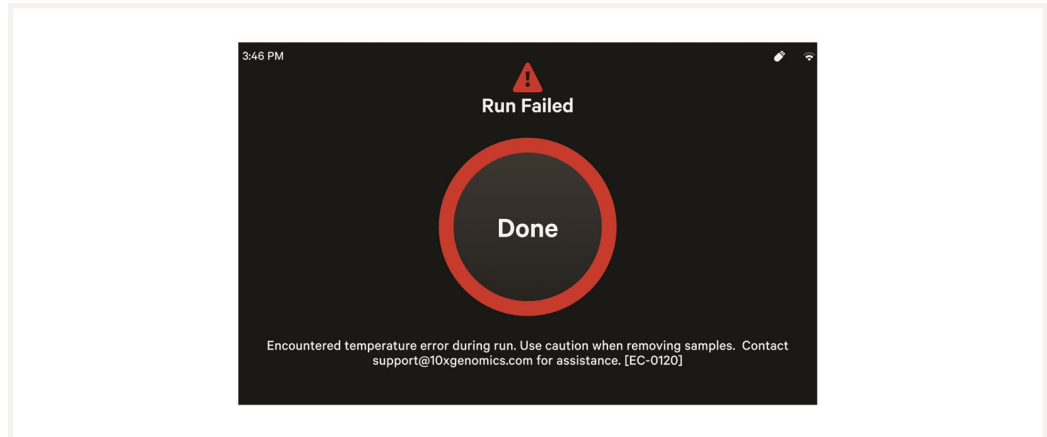

If the Visium CytAssist instrument overheats during an experiment run, the run will fail. A warning message will appear instructing users to carefully remove slides and contact support@10xgenomics.com.

After CytAssist Instrument Run

1. Slide Popped Off of Visium Slide Stage

Upon opening the lid after a successful run, the Visium slide may pop out of the grooves on the Visium Slide Stage. This does not impact assay performance or slide quality.

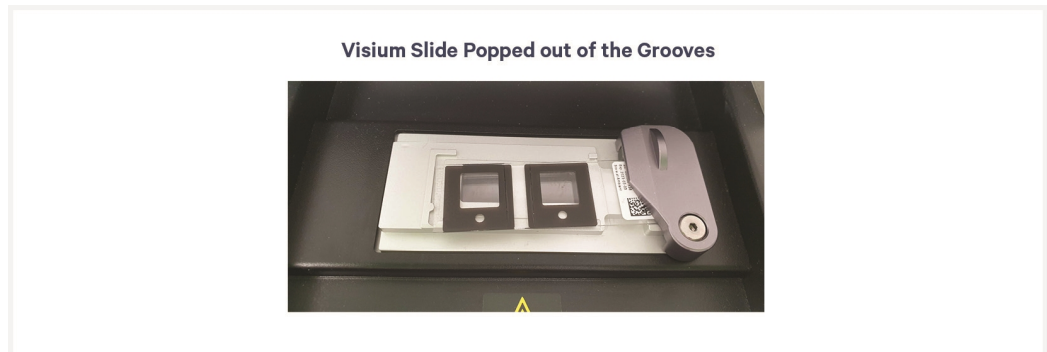

2. Visium CytAssist Slide Removal Delayed

A delay in removing and processing the Visium CytAssist Spatial Gene Expression Slide after run completion may impact data quality.

3. No qPCR Amplification

No amplification during Cycle Number Determination may be due to the following:

- Incorrect qPCR machine programming (i.e. detecting a fluorophore other than SYBR Green)
- Issues with pipetting small volumes
- Failure to neutralize KOH
- Failure to add primers to pre-amp or qPCR mix
- Unusually low recovery from tissue due to high percentage of connective tissue in Capture Area
- Incorrect preparation of Probe and Antibody Tag Release Mix
- Mistake in Probe and Antibody Tag Release Mix addition timing

- Leakage from the Visium CytAssist Tissue Slide Cassette during workflow

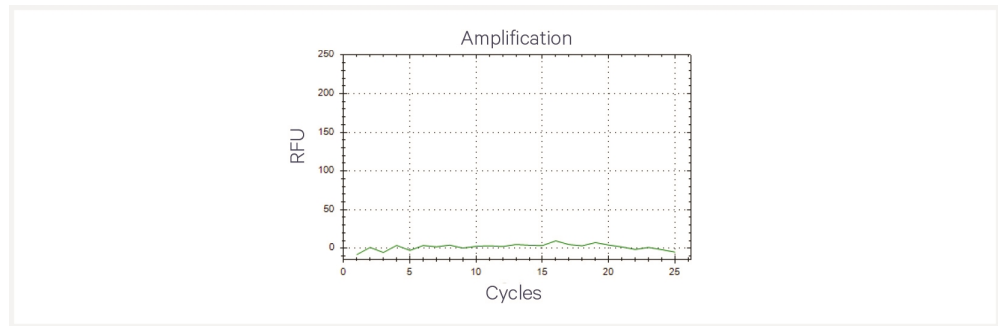

4. Flat Line in Bioanalyzer Library Trace

A normal qPCR output but no peak visible in the Bioanalyzer trace may be due to a mistake in the SI-PCR step, errors during SPRIselect cleanup, an overdilution of the final library, Bioanalyzer issue, or thermal cycler failure.

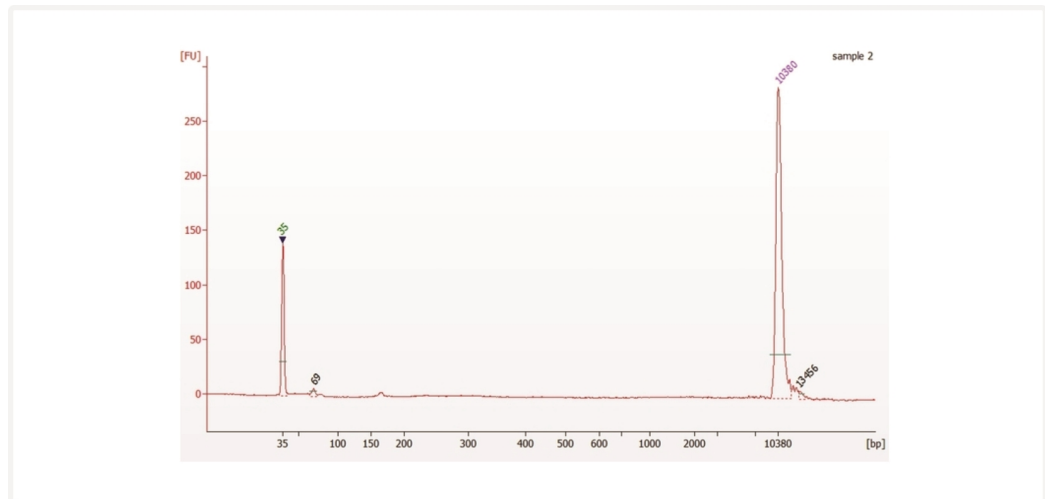

5. Overloaded or Overamplified Trace

Overloaded Trace

The image below is an example of an overloaded trace. Note the double peak at around 240 bp. The low and high molecular weight markers are in low abundance compared to the sample. Ensure the library was diluted 1:50 prior to loading per protocol recommendations. If the library was diluted, ensure the library concentration is within the specification range of the automated electrophoresis kit being used. The library can be quantified using a Qubit and diluted further if appropriate.

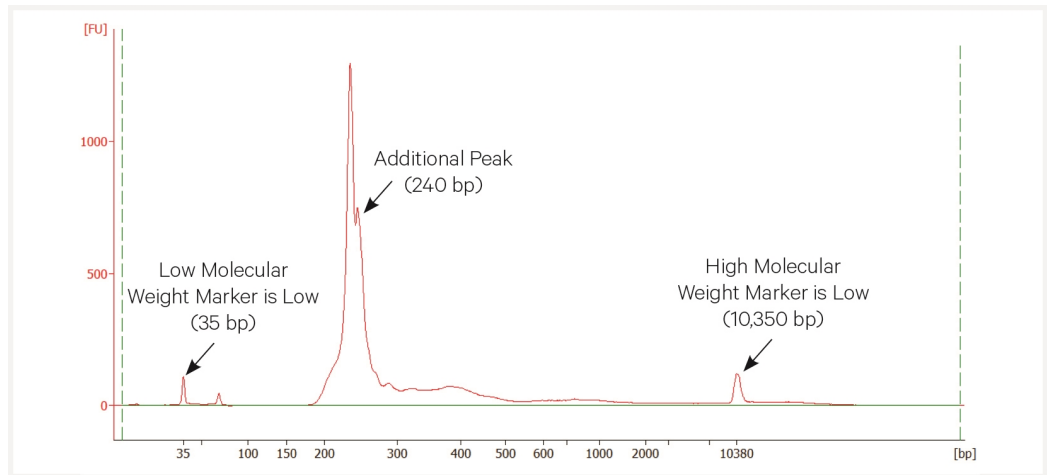

Overamplified Trace

The image below is an example of an overamplified trace. Note peak at 400 bp.

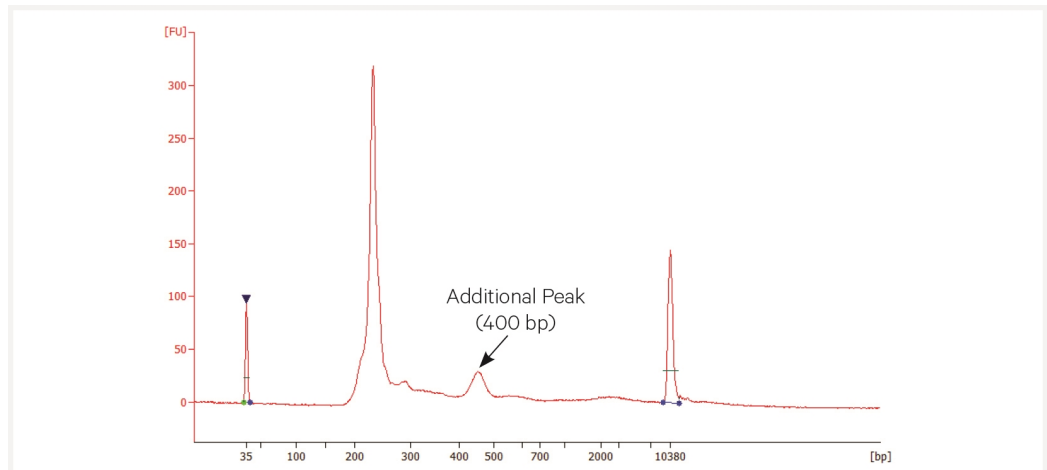

Ensure interpretation of qPCR plot is correct. If necessary, batch samples into separate SI-PCR runs if Cq is > 1 cycle. If batching samples, the cycle number determined should be ± 1 . If needed, select the value in between.

For example, a sample with Cq value of 7.5 should go through 10 cycles during SI-PCR (round up to 8 and add 2) and a sample with a Cq value of 9.2 should go through 12 cycles during SI-PCR (round up to 10 and add 2). If running together, samples should undergo 11 cycles during SI-PCR.

Issues Impacting Tissue Analysis

1. Tissue Detachment and Folding

Tissue detachment may result in a lack of Fraction Reads Usable in the region where detachment occurred. If the tissue has folded on itself, this may also cause elevated UMI counts in the overlapping areas or a loss of spatiality due to ineffective permeabilization. Inspect images carefully to identify these areas. Ensure that slides tested by 10x Genomics were used for tissue placement. For more information, consult the sample preparation documentation described in [Workflow Overview on page 20](#). If tissue detachment is observed during this workflow, contact support@10xgenomics.com

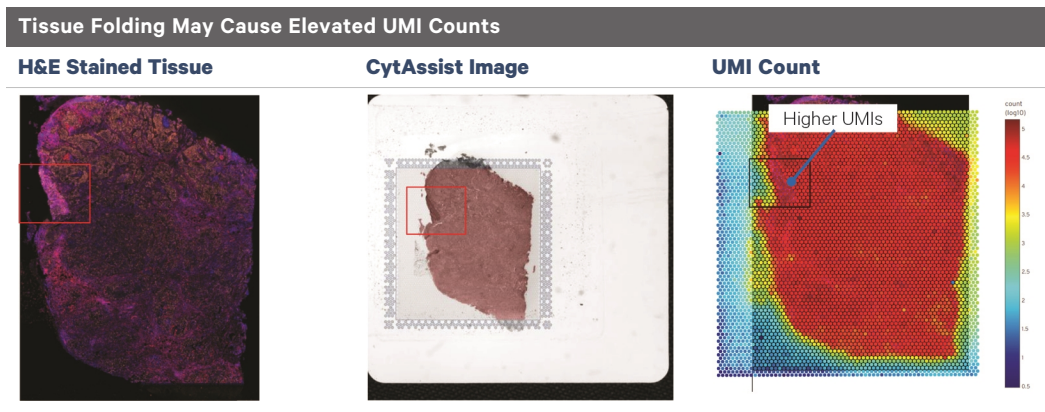
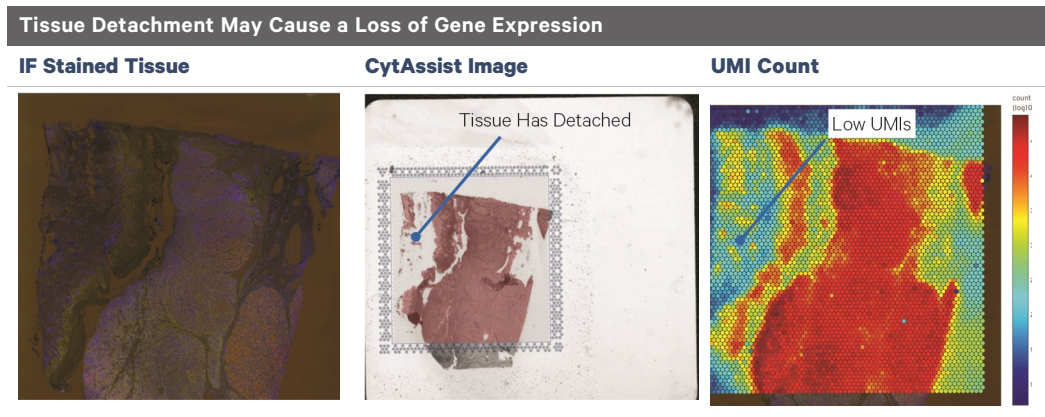

2. Tissue Not Within Allowable Area

Tissue Outside of Allowable Area is Not Analyzed

Tissue Larger than Capture Area

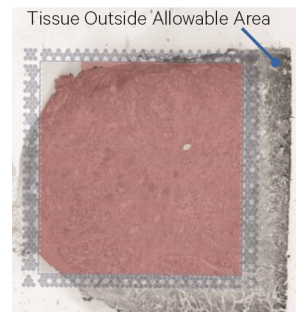

Tissue Not Properly Aligned



Tissues that are not placed within the allowable area on compatible glass slides will not be analyzed. This may occur if the tissue is larger than the Capture Area or if the tissue slide is not properly aligned when loading onto the Tissue Slide Stage.

3. Tissue Segmentation Failure

Examples of Scenarios that Lead to Tissue Segmentation Failure

Inadequate Staining Causes Poor Tissue Segmentation



H&E Stained Tissues Outside of Gasket May Not Undergo Destaining

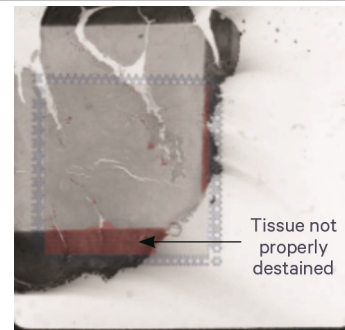

Space Ranger may fail to detect tissue for a variety of reasons, which may necessitate manual fiducial alignment and tissue detection via Loupe Browser. Tissue segmentation failure may result from:

- If the contrast between background and tissue is poor (due to inadequate staining, technical error, or tissue composition) tissue segmentation failure may occur (left image).
- If large tissues that exceed the gasket area of the cassette re-enter the capture area, they may cause a tissue segmentation failure in Space Ranger if they re-enter the Capture Area due to the contrast of this tissue against tissue within the Capture Area (right image).

4. Tissue within Capture Area Not Analyzed

Gasket Covers Portion of Tissue within Capture Area

H&E Stained Tissue

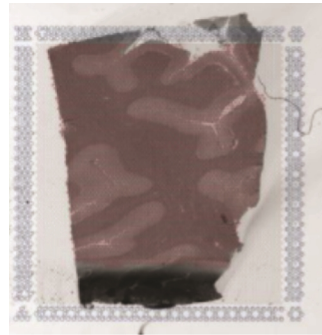

Tissue Plot with Spots Colored by Clustering

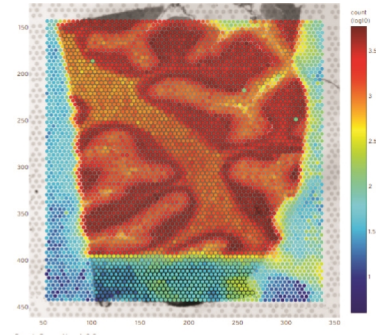

If the gasket covers a portion of the tissue within the Capture Area, that area will not be exposed to the appropriate reagents; thus, probes and antibody tags will not be captured. Gasket obstruction may be caused by improper gasket assembly, resulting in the gasket being placed directly onto areas of interest. In Loupe Browser, manual alignment must be performed to exclude the tissue area obscured by the gasket. Ensure that the area of interest is centered within the gasket.

Additionally, tissue placed within the Capture Area may be excluded from the assay workflow due to improper tissue slide alignment when loading the tissue slide into the Visium CytAssist instrument.

Appendix

Post Library Construction Quantification	145
Agilent TapeStation Traces	146
LabChip Traces	147
Oligonucleotide Sequences	148

Post Library Construction Quantification

- a. Thaw KAPA Library Quantification Kit for Illumina Platforms.
- b. Dilute **2 µl** sample with deionized water to appropriate dilutions that fall within the linear detection range of the KAPA Library Quantification Kit for Illumina Platforms. (For more accurate quantification, make the dilution(s) in duplicate).
- c. Make enough Quantification Master Mix for the DNA dilutions per sample and the DNA Standards (plus 10% excess) using the guidance for 1 reaction volume below.

Quantification Master Mix	1X (µl)
SYBR Fast Master Mix + Primer	12
Water	4
Total	16

- d. Dispense **16 µl** Quantification Master Mix for sample dilutions and DNA Standards into a 96 well PCR plate.
- e. Add **4 µl** sample dilutions and **4 µl** DNA Standards to appropriate wells. Centrifuge briefly.
- f. Prepare a qPCR system with the following protocol. Insert the plate and start the program.

Lid Temperature	Reaction Volume	Run Time
-	20 µl	35 min
Step	Temperature	Time
1	95°C	00:03:00
2	95°C	00:00:05
3	67°C  Read signal	00:00:30
4	Go to Step 2, 29X (Total 30 cycles)	

- g. Follow the manufacturer's recommendations for qPCR-based quantification. For library quantification for sequencer clustering, determine the concentration based on insert size derived from the Bioanalyzer/TapeStation trace.

Agilent TapeStation Traces

Protocol Step 7.3 - Protein Post Library Construction QC

Representative Trace

Run manufacturer's recommended volume of diluted sample (1:50 dilution)

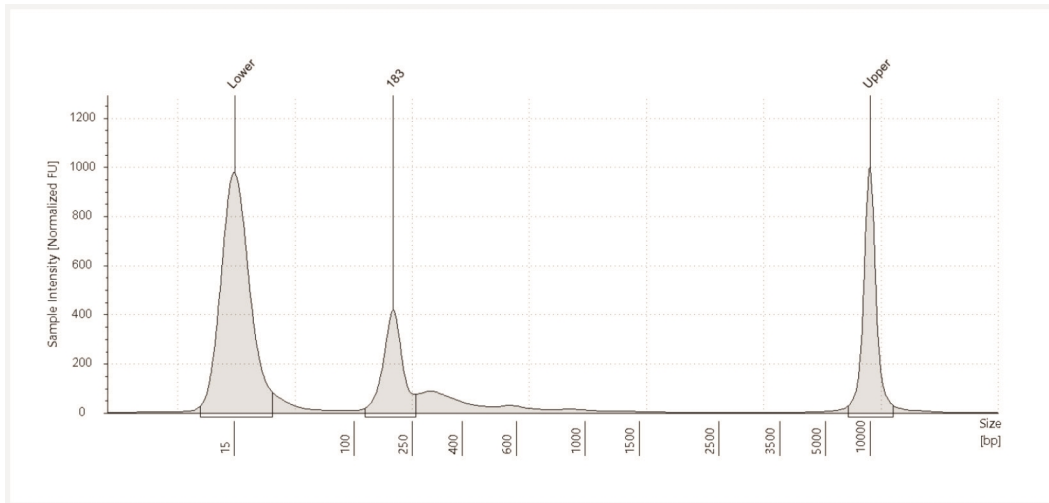

Agilent TapeStation High Sensitivity D5000 ScreenTape was used. Protocol steps correspond to the steps in this User Guide.

Protocol Step 5.3 - GEX Post Library Construction QC

Representative Trace

Run manufacturer's recommended volume of diluted sample (1:50 dilution)

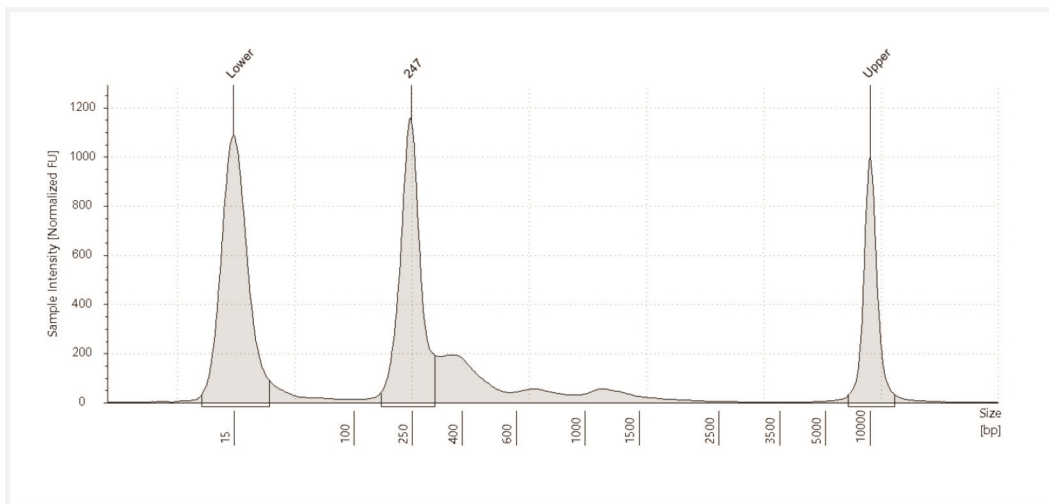

LabChip Traces

Protocol Step 5.3 - GEX Post Library Construction QC

Representative Trace

Run manufacturer's recommended volume of diluted sample (1:5 dilution)

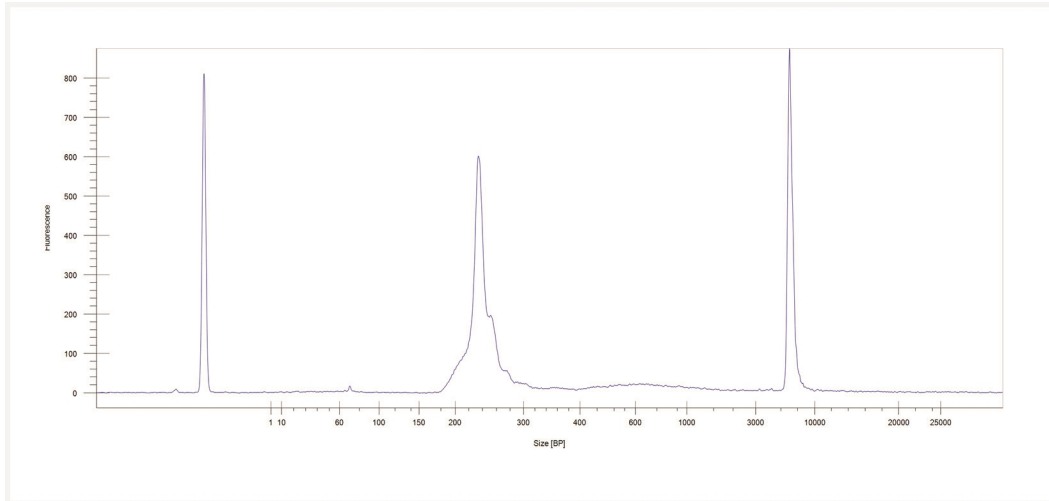

DNA High Sensitivity Reagent Kit was used. Protocol steps correspond to the steps in this User Guide.

Protocol Step 7.3 - Protein Post Library Construction QC

Representative Trace

Run manufacturer's recommended volume of diluted sample (1:5 dilution)

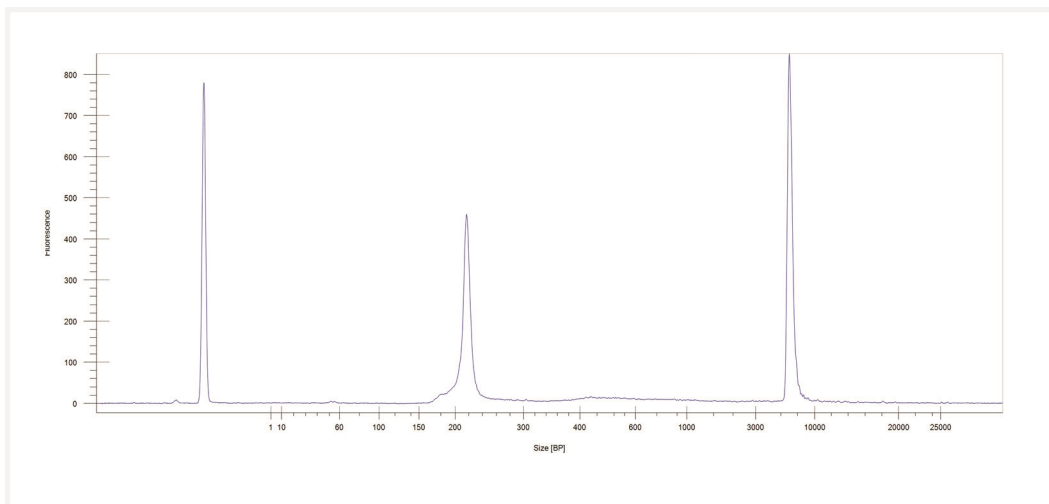

Oligonucleotide Sequences

Slide Primers

5'-CTACACGACGCTCTTCCGATCT-N16-N12-TTTTTTTTTTTTTTTTTTTTTTTTTTTTTTTTTTTVN-3'

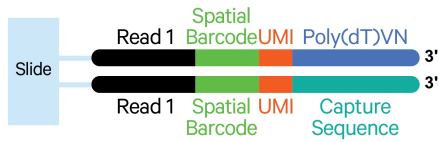

5'-GTCAGATGTGTATAAGAGACAG-N16-N12-N16-3'

Visium CytAssist Spatial Gene Expression - Probe-based Library

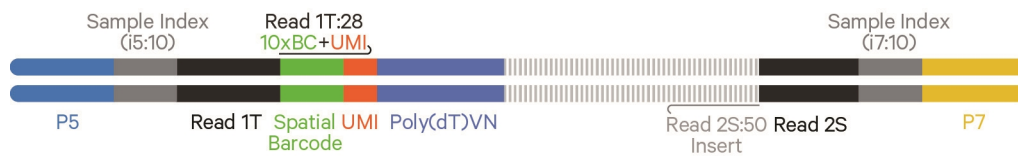

Visium CytAssist Spatial Protein Expression Library

