

User Guide | CG000542 | Rev G

Visium CytAssist

with Readiness Test

For use with:

Visium CytAssist & Accessory Kit, *12-Month Warranty, PN-1000441*

Visium CytAssist & Accessory Kit, *24-Month Warranty, PN-1000442*

Visium CytAssist, *Refurbished, PN-1000432R*



Notices

Document Number

CG000542 | Rev G

Legal Notices

© 2024 10x Genomics, Inc. (10x Genomics). All rights reserved. Duplication and/or reproduction of all or any portion of this document without the express written consent of 10x Genomics, is strictly forbidden. Nothing contained herein shall constitute any warranty, express or implied, as to the performance of any products described herein. Any and all warranties applicable to any products are set forth in the applicable terms and conditions of sale accompanying the purchase of such product. 10x Genomics provides no warranty and hereby disclaims any and all warranties as to the use of any third-party products or protocols described herein. The use of products described herein is subject to certain restrictions as set forth in the applicable terms and conditions of sale accompanying the purchase of such product. A non-exhaustive list of 10x Genomics' marks, many of which are registered in the United States and other countries can be viewed at: www.10xgenomics.com/trademarks. 10x Genomics may refer to the products or services offered by other companies by their brand name or company name solely for clarity, and does not claim any rights in those third-party marks or names. 10x Genomics products may be covered by one or more of the patents as indicated at: www.10xgenomics.com/patents. The use of products described herein is subject to 10x Genomics Terms and Conditions of Sale, available at www.10xgenomics.com/legal-notices, or such other terms that have been agreed to in writing between 10x Genomics and user. All products and services described herein are intended FOR RESEARCH USE ONLY and NOT FOR USE IN DIAGNOSTIC PROCEDURES.

Instrument & Licensed Software Updates Warranties

Updates to existing Instruments and Licensed Software may be required to enable customers to use new or existing products. In the event of an Instrument failure resulting from an update, such failed Instrument will be replaced or repaired in accordance with the 10x Limited Warranty, Assurance Plan or service agreement, only if such Instrument is covered by any of the foregoing at the time of such failure. Instruments not covered under a current 10x Limited Warranty, Assurance Plan or service agreement will not be replaced or repaired.

Support

Email: support@10xgenomics.com

10x Genomics

6230 Stoneridge Mall Road

Pleasanton, CA 94588 USA

Document Revision Summary

Document Number

CG000542 | Rev G

Title

Visium CytAssist Instrument User Guide with Readiness Test

Revision

Rev F to Rev G

Revision Date

September 2024

Description of Changes

- Updated title page to include new part number for refurbished instrument, update formatting, and remove accessory kit.
- Updated bleach concentration to 10% (p. 33, 45, 58, 68)

Table of Contents

Introduction	5
Introduction	6
Product Identification Label	7
Product Specifications	7
Safety & Compliance Information	8
Safety	9
Regulatory	10
System Components	11
System Components	12
Accessory Kits	13
Tips & Best Practices	14
Icons	15
Check Tissue Placement on Slide	15
Tissue Slide Placement on Tissue Slide Stage	16
Visium Slide Placement on Visium Slide Stage	21
10x Genomics Cloud	23
Barcode Scanner	23
System Operation	24
Step 1: Installation	25
Step 2: First-Time Use	28
Step 3: Readiness Test	32
Step 4: Main Operation	34
Menu Options	38
Menu Options	39
Firmware Update Procedure	44
Network Shared Folder	46
Network Shared Folder Troubleshooting	56
Maintenance	57
System Maintenance	58
Moving & Shipping the Instrument	59
Troubleshooting	63
Troubleshooting	64
Error Screens	69



Introduction

Introduction

Product Identification

Product Specifications

Introduction

The Visium CytAssist is a compact, bench top instrument that automates the transfer of analyte-derived molecules from standard glass slides to Visium slides, enabling spatial profiling insights from an expanded range of samples. The CytAssist instrument allows pre-sectioned tissues to be used for the Visium workflow and eliminates the need to directly section onto Visium slides.

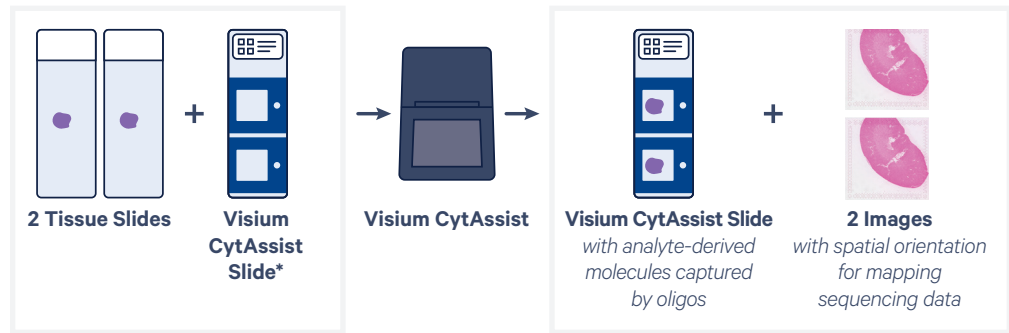

**slides are representative*

Further optimization of Visium experiments can be achieved by pre-screening tissue sections using standard histological techniques to find biologically significant sections, then using the CytAssist to align those sections within the Visium Capture Areas. Using Visium Cytassist, analyte-derived molecules from up to two tissue sections can be captured on CytAssist specific slides in less than one hour per run.

Highlights

- Simplify sample handling with automated transfer of analyte-derived molecules from standard slides onto the Capture Area of a Visium slide
- Eliminate the need to section directly onto the Visium slide, and expand sample compatibility to pre-sectioned slides
- Maximize insights from Visium experiments by pre-screening tissue sections with standard histological techniques to select the most biologically significant sections
- Precisely capture analyte-derived molecules from up to two tissue sections per run in less than one hour using CytAssist specific slides and reagents

Product Identification Label

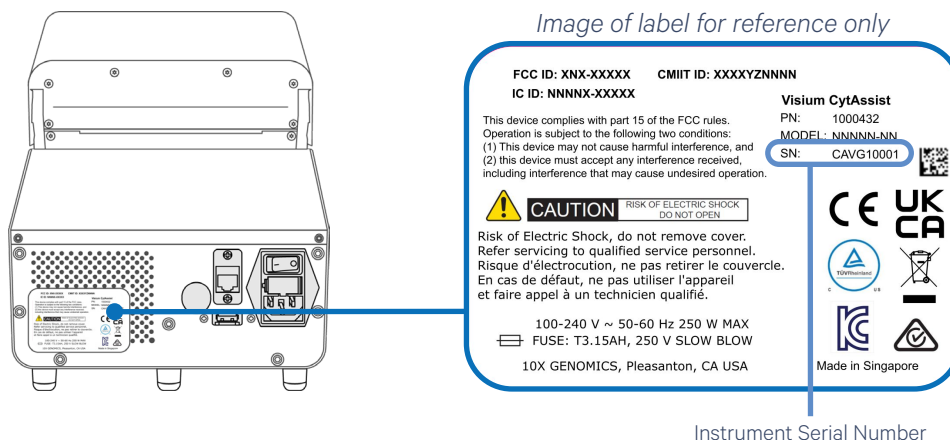

Product Specifications

Parameter	Specifications
Weight	~18.3 lb (8.3 kg)
Instrument Dimensions with: Lid closed Lid open Maximum height	W D H 8" [203 mm] × 12.3" [313 mm] × 9.76" [248 mm] 8" [203 mm] × 12.3" [313 mm] × 12.3" [312 mm] 13.1" [334 mm]
Electrical Requirements Nominal <i>from a standard 3-prong wall receptacle that includes a safety ground pin</i>	100-240 VAC, 50/60 Hz, 250 W 80-264 V operational range (+/- 10% of nominal) Over voltage Category II (standard receptacle)
Pollution	Degree 2 (Indoor Use Only)
Ventilation Requirement	Minimum 4" [10 cm] Around all sides
Operating Temperature	64-82°F [18-28°C] Use in a typical indoor laboratory environment. Extreme temperature conditions will affect the sensitive reagents used with the instrument.
Humidity	30-80% R.H. non-condensing
Cameras	Two color cameras, 4.625 µm/pixel resolution
Power Cable Length <i>Power cables will be in accordance with regional specifications</i>	6-7 ft [2 m] Standard

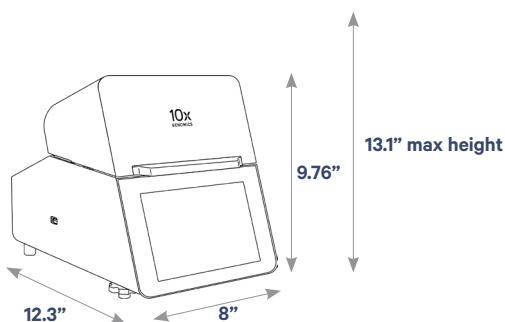

!
 The instrument requires a
 ~20 min cool down between runs.



Safety & Compliance Information

Safety





Regulatory

Safety

Before operation, ensure that all potential users have received:

- Instruction in general safety practices for laboratories.
- Instruction in specific safety practices for the instrument.
- All related Safety Data Sheet (SDS) documents.

Precautions are illustrated in the following way:

Symbols	Description
	The general Warning symbol indicates the possibility of damaging the instrument or compromising the results of a method.
	The Electrical Hazard symbol indicates the presence of electrical components that can be harmful to the operator if handled incorrectly.
	The Mechanical Hazard symbol indicates the presence of moving mechanical parts that can be harmful to the operator if handled incorrectly.
	The Hazardous Materials symbol indicates the presence of materials that are toxic or otherwise harmful to the operator if handled incorrectly.
	The Biohazard symbol indicates the presence of biological samples that can be harmful to the operator if handled incorrectly.



Ensure ground is reliably connected before plugging the instrument’s power cord into the power source (receptacle). *Grounding is required to prevent electric shock. If the power source is not grounded, qualified personnel must first install a reliable safety ground.*



Pinch risk: Ensure no obstructions or fingers present near closing lid.







Warning: Avoid using the Visium CytAssist in a manner not specified by 10x Genomics. *The Visium CytAssist has been designed to protect the user. If used improperly, the intended user protections can be impaired.*



Hot Surface: The Visium Slide Stage may be hot after a run. Exercise caution when removing the Visium slide.

Regulatory

The Visium CytAssist has been designed, tested, and certified to be in compliance with the following standards:

Certification	Standards
	TUV Certification only for Visium CytAssist UL 61010-1:2012 and CAN/CSA C22.2 No. 61010-1-12 with a cTUVus mark to indicate that the product has been tested and certified to Canadian and US standards by TÜV Rheinland and can be legally installed in those countries.
	IEC/EN 61010-1:2010 (3rd Edition): Safety Requirements for Electrical Equipment for Measurement, Control, and Laboratory use.
	EN 61326-1:2013: Electrical Equipment for Measurement, Control and Laboratory Use. EMC Requirements.
	The RCM mark indicates an electrical product complies with all the requirements of the electrical and EMC regulations of Australia and New Zealand in accordance with AS/NZS Standards
	CE Mark indicates that assembly is covered by a Declaration of Conformity, and has been declared in conformity with the provisions of all applicable directives in the European Union.
	UKCA Mark indicates that assembly is covered by a Declaration of Conformity, and has been declared in conformity with the provisions of all applicable directives in the United Kingdom.
	EN 61326-2-6: Specifies minimum requirements for immunity and emissions regarding electromagnetic compatibility for in vitro diagnostic medical equipment, taking into account the particularities and specific aspects of this electrical equipment and their electromagnetic environment.
	EN 61000-3-2: Electromagnetic compatibility (EMC) - Part 3-2: Limits - Limits for harmonic current emissions (equipment input current ≤16 A per phase).
	EN 61000-3-3: Electromagnetic compatibility (EMC) - Part 3-3: Limits - Limitation of voltage changes, voltage fluctuations and flicker in public low-voltage supply systems, for equipment with rated current ≤16 A per phase and not subject to conditional connection.
	RoHS Directive (2011/65/EU) and amendment (EU) 2015/863: Restriction of the use of certain hazardous substances in electrical and electronic equipment.
	WEEE Directive (2012/19/EU): Waste Electrical and Electronic Equipment.
	FCC ID: N6C-SDPAC, IC: 4908A-SDPAC FCC Part 15 Class A. NOTE: This equipment has been tested and found to comply with the limits for a Class A digital device, pursuant to part 15 of the FCC Rules. These limits are designed to provide reasonable protection against harmful interference when the equipment is operated in a commercial environment. This equipment generates, uses, and can radiate radio frequency energy and, if not installed and used in accordance with the instruction manual, may cause harmful interference to radio communications. Operation of this equipment in a residential area is likely to cause harmful interference in which case the user will be required to correct the interference at his own expense. This device complies with part 15 of the FCC Rules. Operation is subject to the following two conditions: (1) This device may not cause harmful interference, and (2) this device must accept any interference received, including interference that may cause undesired operation.
	ICES-003 (Canada): This Class A digital apparatus complies with Canadian ICES-003. Cet appareil numérique de la classe A est conforme à la norme NMB-003 du Canada.



System Components

System Components

Accessory Kits

System Components

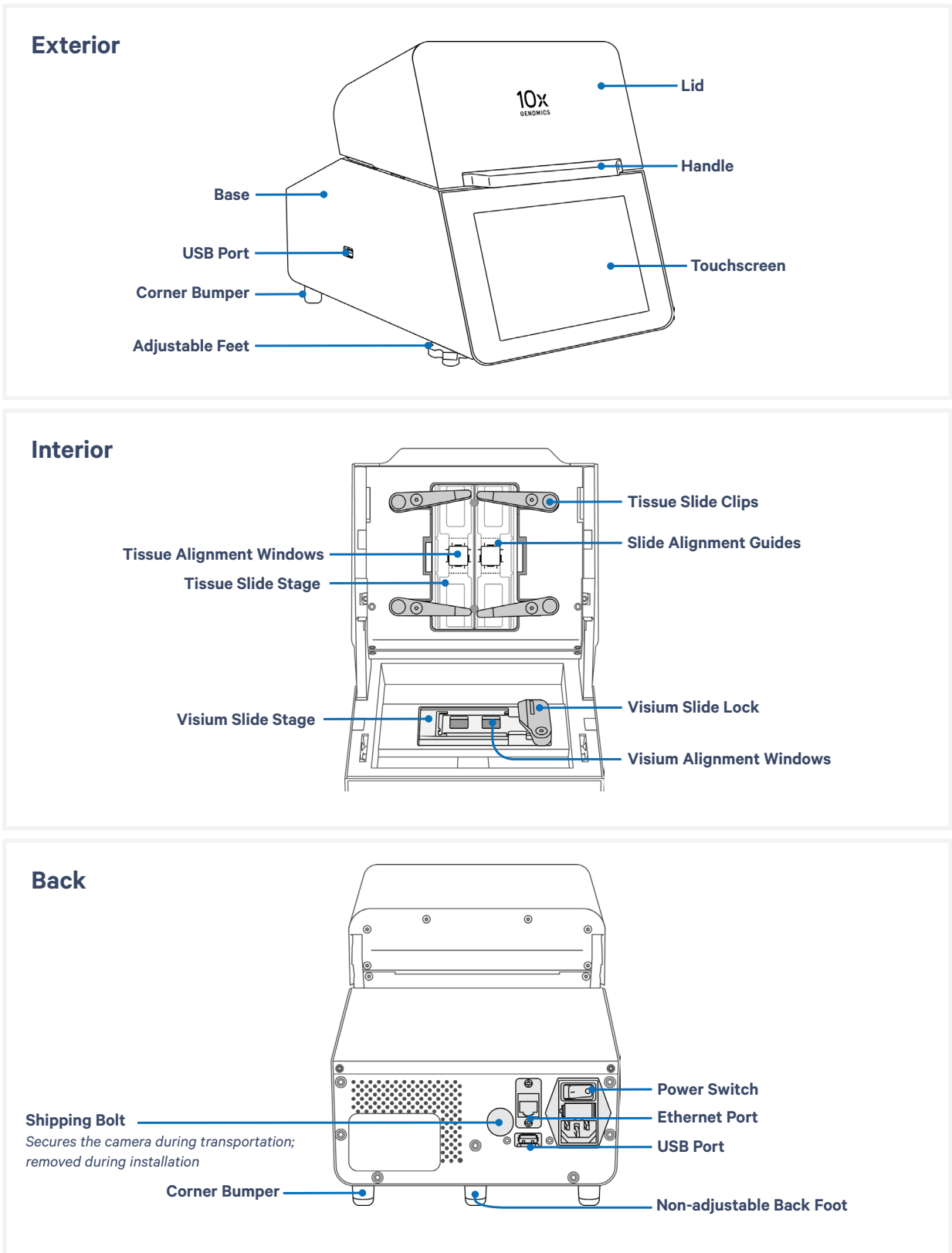

Accessory Kits

Visium CytAssist Instrument Accessory Kit PN-1000433

Product	#	Part Number (Item)
Universal Power Cord, 10 Amp-250 V <i>(IEC 60320 C-14, with C-13 Detachable Adapters)</i>	1	3000603
USB, 8 GB <i>The Visium CytAssist instrument is compatible with VFAT, exFAT, and FAT32 formatted USBs.</i>	1	3000664
Visium CytAssist Quick Reference Cards – for Accessory Kit Instruction	1	CG000548
Visium CytAssist Training Kit	1	1000458
Visium CytAssist Training Slide Assembly	2	2000681
Blank Slides	2	3000868
Visium CytAssist Calibration Kit	1	1000459
Visium CytAssist Calibration Slide Assembly	1	2000680
Blank Slides	2	3000868

Additional Items

Product	#	Part Number (Item)
Shipping Bolt <i>Located in the back of the instrument during transportation; removed during installation and stored apart from the instrument</i>	1	3000986

Tips & Best Practices

Icons

Check Tissue Placement on Slide

Tissue Slide Placement on Tissue Slide Stage

Visium Slide Placement on Visium Slide Stage

10x Genomics Cloud



Icons



Tips & Best Practices section includes additional guidance



Signifies critical step requiring accurate execution



Troubleshooting section includes additional guidance

Check Tissue Placement on Slide

Check Slide Dimensions

While slides are specified as being a certain size by the manufacturer, manufacturing tolerances may lead to dimensions that are too small or large to be compatible with Visium CytAssist. Ensure that slides used on the instrument are within supported tolerances. Supported slide widths may vary from assay to assay.

Refer to the assay-specific protocol planner to determine compatible slide sizes. Consult *Visium HD Protocol Planner (CG000698)* or *Visium CytAssist Protocol Planner (CG000556)*.

Check Tissue Placement on Slide

Determine if the tissue section is located in an area that results in successful analyte-derived molecule transfer and imaging. This allowable area will depend on the width and type of slide. To ensure compatibility with the Visium CytAssist, tissue sections must be placed in specific areas on a blank slide. Tested slides are listed in the assay-specific protocol planner. Diagrams to assist in verifying tissue placement are found in the Visium CytAssist Accessory Kit Instruction Quick Reference Card (CG000548).

Tissue Slide Placement on Tissue Slide Stage

Position Tissue Slide on the Tissue Slide Stage

Use this section to determine if the tissue section is located in an area that results in successful analyte-derived molecule transfer and CytAssist-mediated imaging. The Visium CytAssist Quick Reference Cards – for Accessory Kit Instruction (CG000548) contain the same diagrams shown below for checking slide placement.

- a. Ensure the target tissue area on each slide fits within the allowable area of the Tissue Slide Stage.

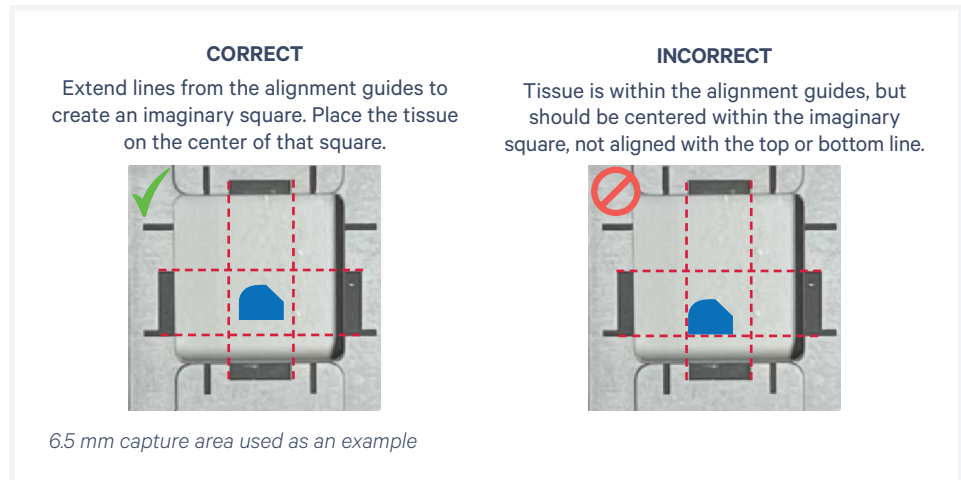

Tissue Slide Placement on Tissue Slide Stage *contd.*

- b. Align tissue to the center of the alignment guides for 6.5 mm (rectangles) or 11 mm (lines) Capture Areas on either the left or right side of the stage. Align the center of the tissue region of interest to the center of the Capture Area, instead of aligning the edge of the region to the edge of the Capture Area.



If printing this page:

Select "actual size" or "100%" to print to scale. The blue Capture Area should measure 11 mm and the green capture area should measure 6.5 mm.

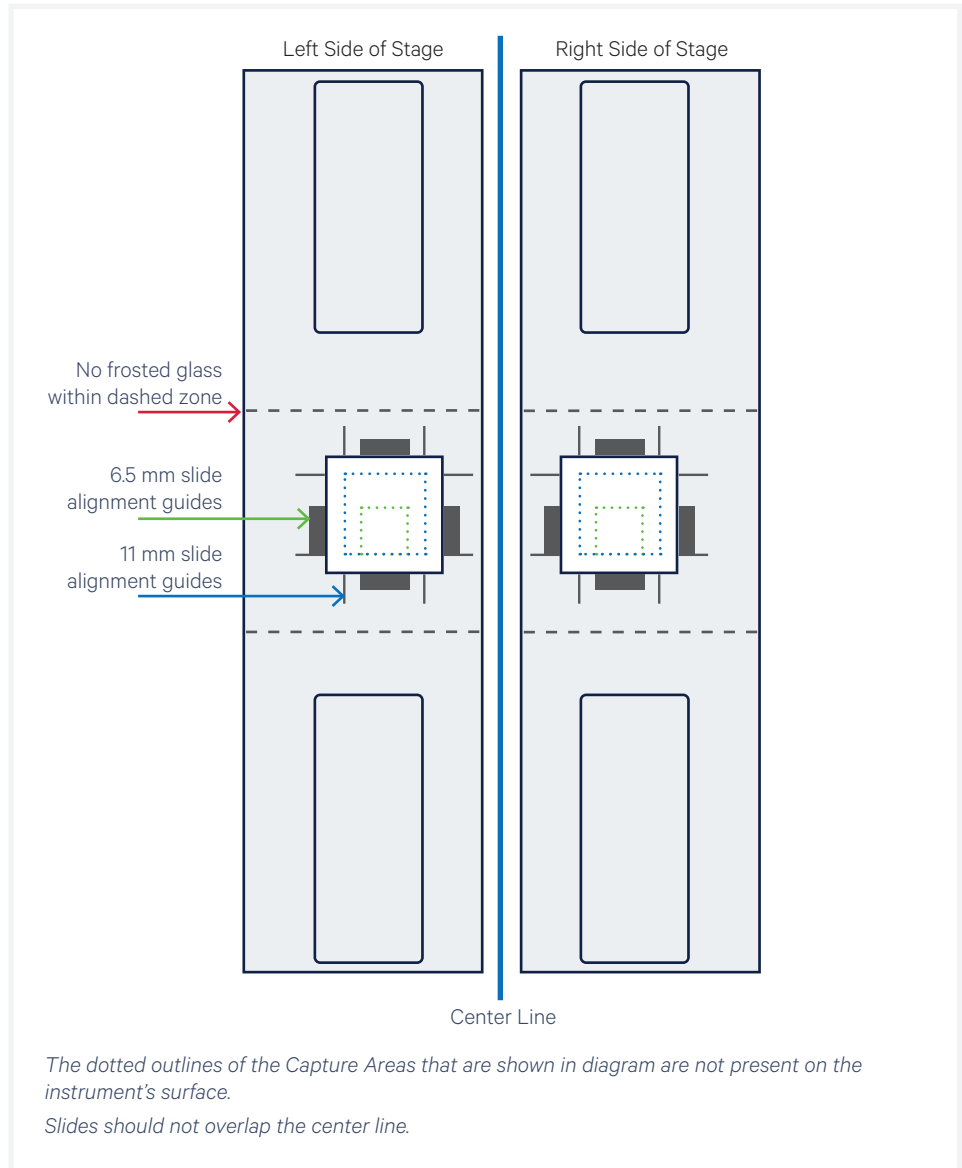

Tissue Slide Placement on Tissue Slide Stage
contd.

- c. If necessary, rotate the slide 180° as shown below to better place off-center tissues closer to the center line. Slides should not cross/overlap the center line.

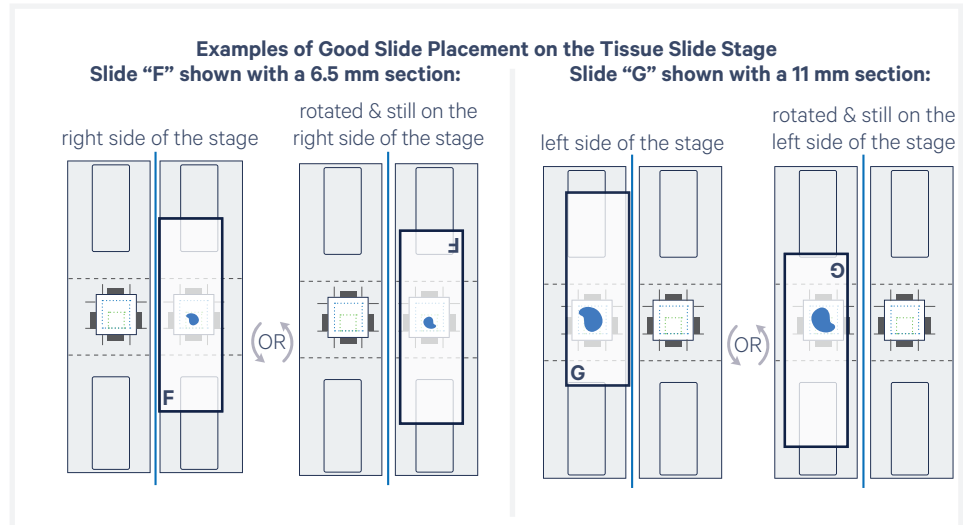

Tissue Slide Placement on Tissue Slide Stage
contd.

Fine Adjustments

The outside of the alignment guides, shown in the image below in red, mark the inner boundaries of the fiducial frame on a Capture Area. They mark a distance **approximately 6 mm** (6.5 mm slides) or **10.5 mm** (11 mm slides) wide on each side and surround the target region ensured to align within the fiducial frame.

When placing a tissue slide on the Tissue Slide Stage, center the tissue or area of interest within the area inside the outer edges of the alignment guides (area noted in green in the images).

Alignment guide dimensions and locations are designed with a high tolerance to minimize data loss. Tissue within the alignment guides is ensured to overlap with the Capture Area during a successful run. Tissue outside of these guides may be captured (area in yellow in the images), but it is not ensured. 10x Genomics recommends placing high-priority areas of the tissue within the alignment guides.

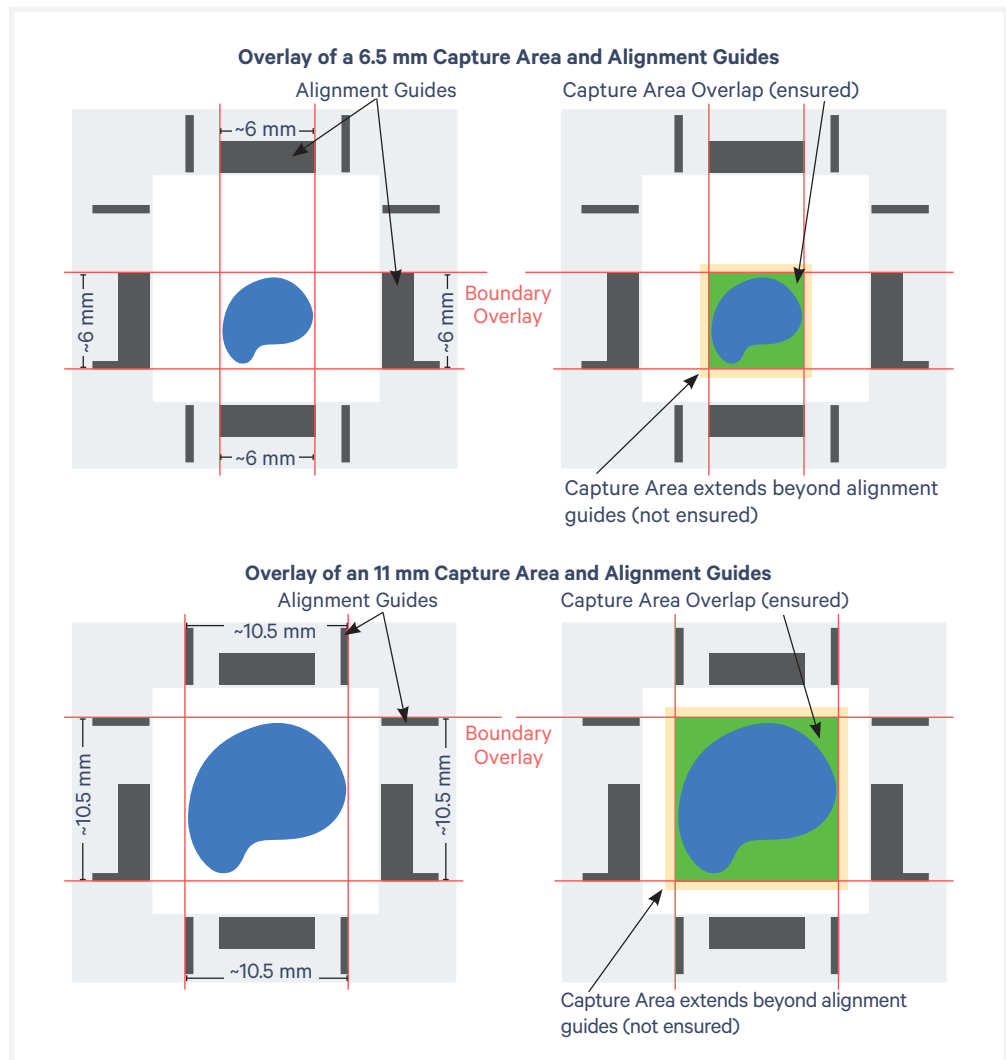

Tissue Slide Placement on Tissue Slide Stage

contd.

Load Tissue Slides onto the Tissue Slide Stage

- a. Press down on the wide end of clip to lift and pivot the narrow end of the clip. Pivot the clips to their outermost position.

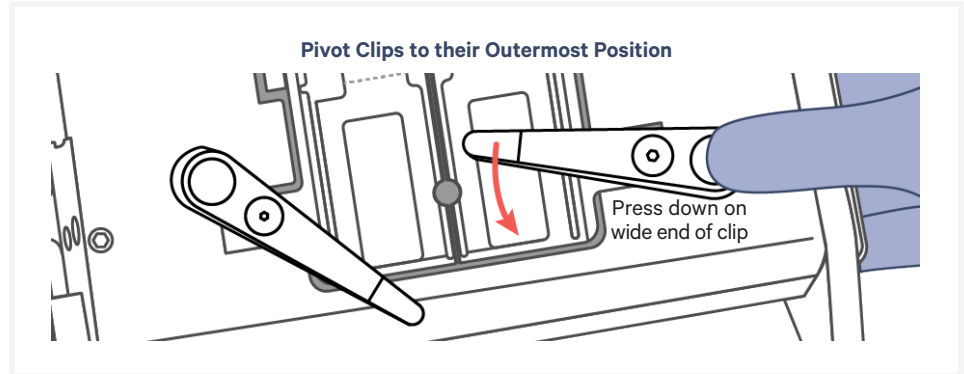

- b. Lay the tissue slide flat against the stage surface. Both hands needed: use one hand to hold the slide in place and the other to pivot the clips and overlap the slide. Load the slide against the grooves. Ensure that at least one clip secures the slide before adjusting the position further.
- c. Use fingers to finely adjust the position of the tissue within the alignment guides. **DO NOT** touch the tissue section.

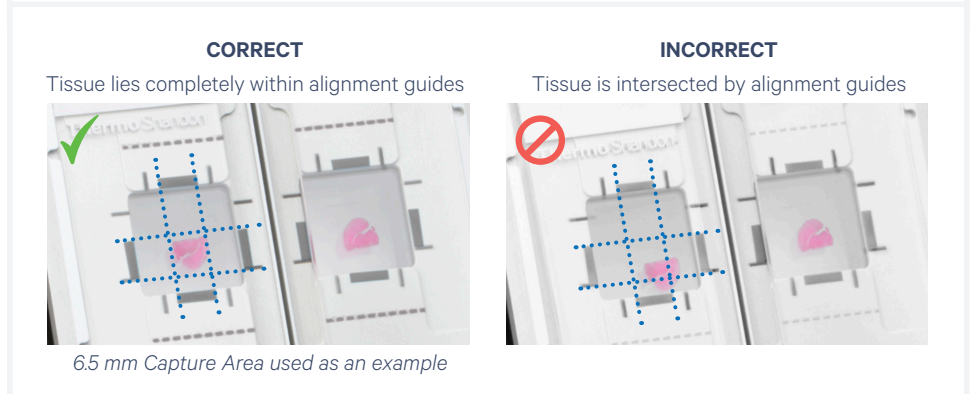
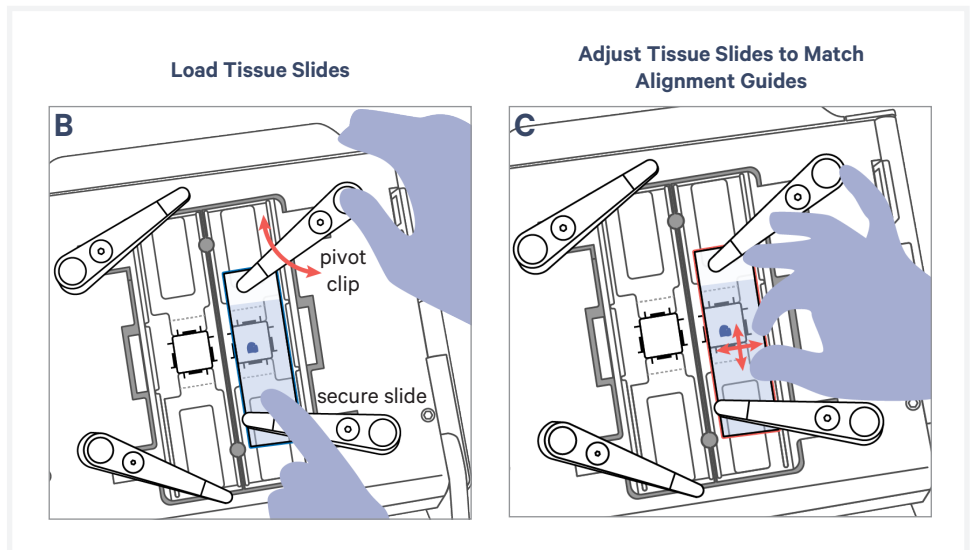

Tissue Slide Placement on Tissue Slide Stage
contd.

- d. If only one tissue on one slide will be loaded, use a blank slide for the second position on the Tissue Slide Stage.

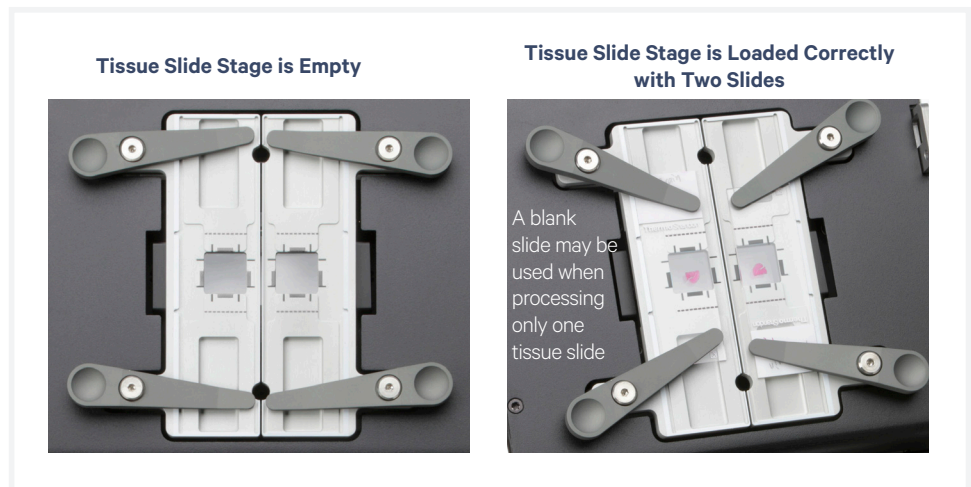

Visium Slide Placement on Visium Slide Stage

Visium Slides

The Visium Slide Stage holds one of the following at a time:

- Visium Slide, 6.5 mm or 11 mm
- Visium CytAssist Training Slide
- Visium CytAssist Calibration Slide

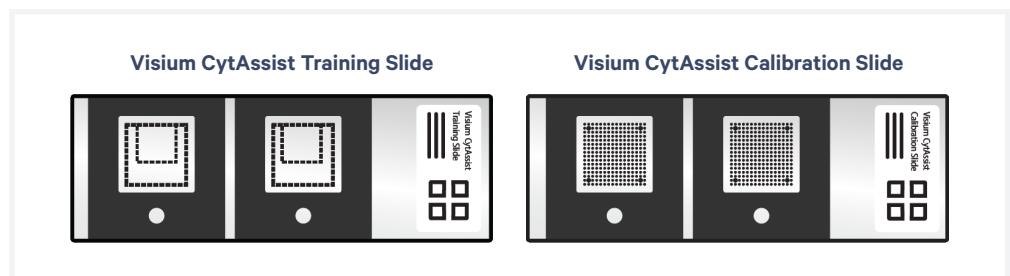

Visium Slide Placement on Visium Slide Stage
contd.

Load Visium Slides onto the Visium Slide Stage

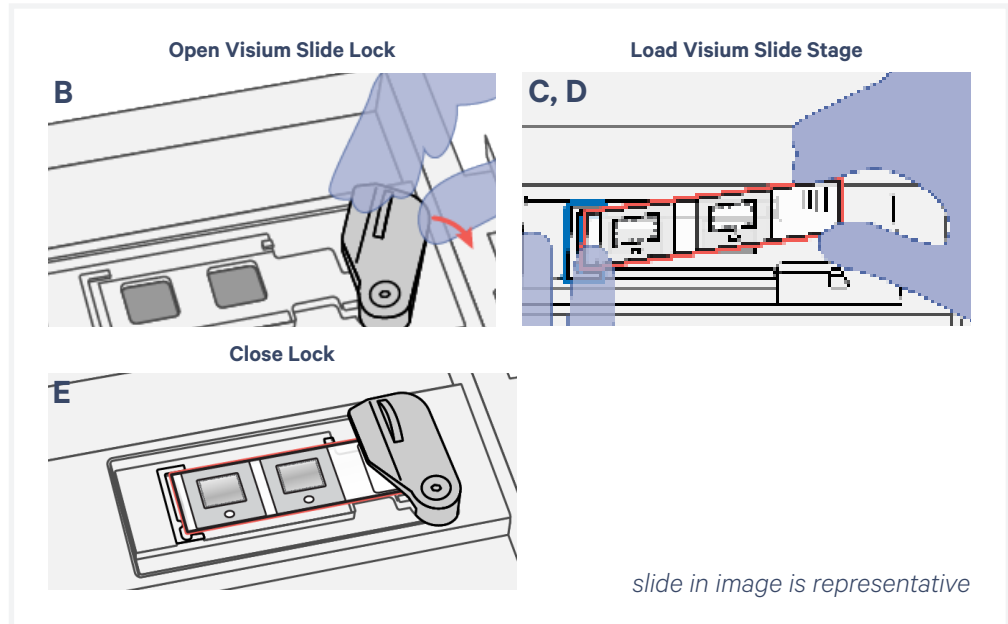

- a. Inspect the Visium Slide Stage for dust and debris, and clean according to the [Maintenance](#) section, as needed.
- b. Open the Visium Slide Lock by using one finger to pivot.
- c. Line up the slide with the label face up and oriented to the right.
- d. Fit the slide within the raised grooves on the left, top and bottom.
- e. Hold the slide in place with one hand while slowly closing the Visium Slide Lock. The lock will partially obscure the slide label.

Visium Slide Stage is Loaded Correctly with One Slide

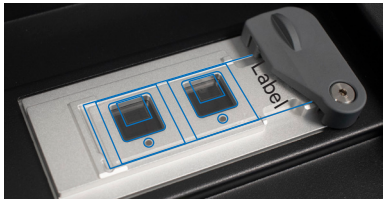

Slide fits inside the grooves.
 Label on the right is partially obscured by the lock.
 Spacer window lines up with alignment windows.

INCORRECT

Slide does not fit inside the grooves.
 Spacer window does not line up with alignment windows.

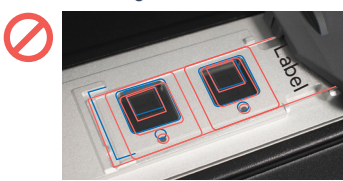

INCORRECT

Label is on the left.
 Spacer window does not line up with alignment windows.

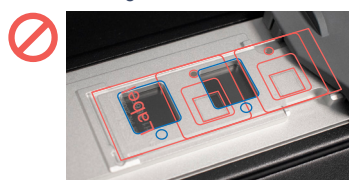

Visium Slide Placement on Visium Slide Stage

contd.

The image below demonstrates how movement of the tissue slides affects where target molecules will end up on the Visium Spatial Gene Expression Slide.

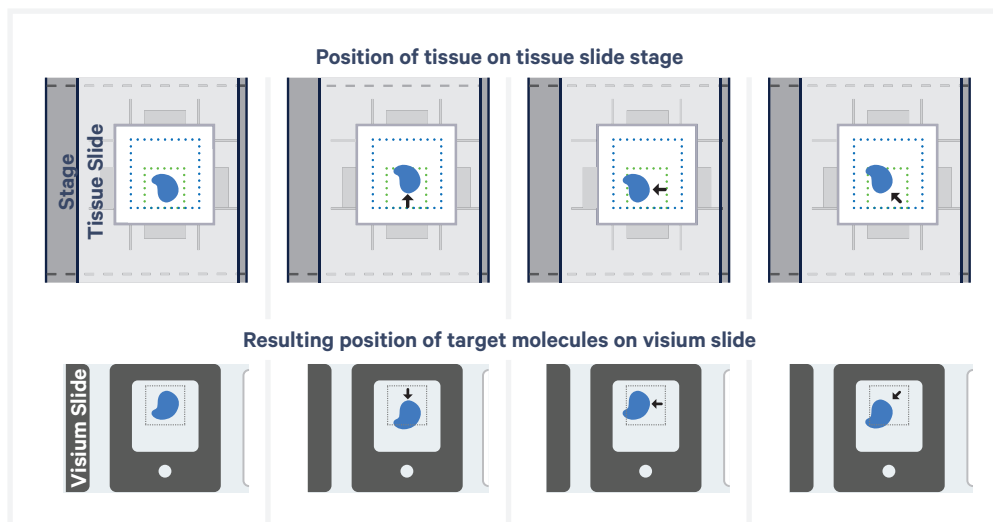

10x Genomics Cloud

10x Genomics Cloud (accessible through cloud.10xgenomics.com/instruments), allows creation of a universal user account for all of the web services offered by 10x Genomics. Using the instrument management tool, users can access the instrument information and download the latest firmware updates for their instruments.

Each Visium CytAssist instrument is required to be registered to the 10x Genomics Cloud during the First Time Use (FTU) set up process. Users may register multiple instruments to their accounts, and each instrument can optionally be registered to multiple 10x Genomics accounts. Instruments connected to the network can also transfer serviceability data directly to 10x Genomics, enabling streamlined customer service.

Barcode Scanner

Use a barcode scanner to input the slide serial number, instead of manually entering on the touchscreen. The Zebra Standard Range Scanner with USB (PN – DS4608-SR) is supported by 10x Genomics. Other scanners may be compatible, but have not been explicitly tested by 10x Genomics. Update the Visium CytAssist to firmware v2.0.0 or higher to enable this feature.

- a. Connect the barcode scanner via the USB-A port on the side or rear of the instrument.
- b. Onscreen, tap on the “Input slide serial number” box.
- c. Scan the QR code on the Visium slide (which may be loaded onto the Visium Slide Stage of the instrument). *The slide number field must be empty in order for the scanner to input the slide serial number correctly.*

System Operation

Step 1: Installation

Step 2: First-Time Use

Step 3: Readiness Test

Step 4: Main Operation

Step 1: Installation

Bench Space

Follow these instructions for installation to operate the Visium CytAssist properly and obtain maximum performance of the system. Before unboxing the instrument choose a location that:

- Is not situated in direct sunlight.
Direct sunlight leads to inadequate cooling conditions or rapid evaporation of reagents.
- Includes a level, sturdy laboratory bench that is not subject to movement or vibration.
- Provides maximum bench space (front to back).
Avoid areas that have obstruction in the rear such as power strips or hose lines (spigots for vacuum or air).
- Allows access to the plug at the wall receptacle (to safely disconnect power).
- Allows access to the detachable power cord at the rear of the instrument
- Provides a minimum of 4" (10 cm) clearance around unit to allow free air circulation.



Warning: Avoid using the Visium CytAssist in a manner not specified by 10x Genomics. *The Visium CytAssist has been designed to protect the user. If used improperly, the intended user protections can be impaired.*



General Power Safety

Grounding is required to prevent electric shock. If the power source is not grounded, qualified personnel must first install a reliable safety ground.

- DO NOT plug the instrument power cable into an electrical outlet if the power cable is damaged.
- To prevent electric shock, plug the instrument power cable into properly grounded outlets.
- When using an extension cable or power strip, ensure that the total ampere rating of the instrument does not exceed the ampere rating of the extension cable. The extension cable must be designed for grounded plugs and plugged into a grounded wall outlet.
- Be sure to grasp the plug, not the cable, when disconnecting the instrument from an electric socket.

Step 1: Installation

contd.

Unbox

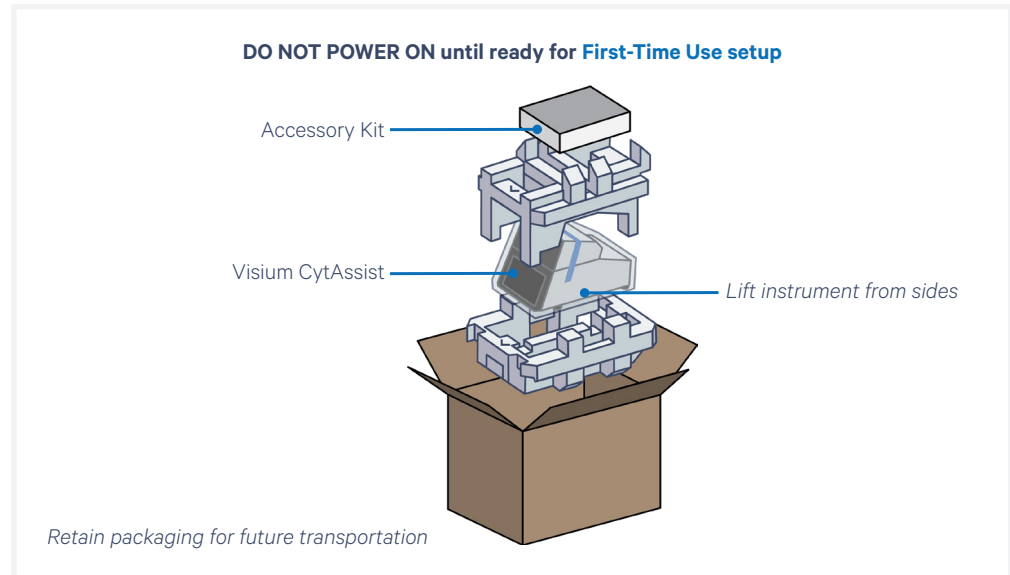

- a. Open box according to box label “this side up.”
Carefully cut or remove the tape on the top of the box and open the top flaps. Ensure that cut is not too deep as it may damage the Instrument Accessory Kit box.
- b. Remove the Instrument Accessory Kit box, documents, and packaging material.
- c. Lift the instrument from the sides. Place on bench top. Carefully remove all packaging materials/tape from the exterior of the instrument. Retain all packaging materials in the event that the instrument needs to be moved (see [Moving & Shipping the Instrument](#) section).
-  d. Remove Shipping Bolt from the back of the instrument. The Shipping Bolt secures and stabilizes internal components to prevent damage during shipping. Retain Shipping Bolt in a marked bag or container in a convenient location in case the instrument requires future transportation.

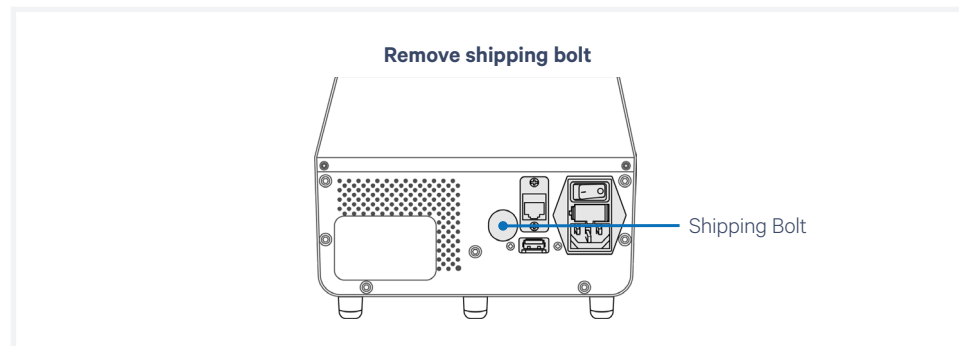

- e. Open lid. Carefully remove tape from the four Tissue Slide Clips and the Visium Slide Lock as well as from the opposite end.

Step 1: Installation

contd.

- f. Remove glass protective films from the alignment windows on both stages. Close the lid (clicking sound indicates closure).

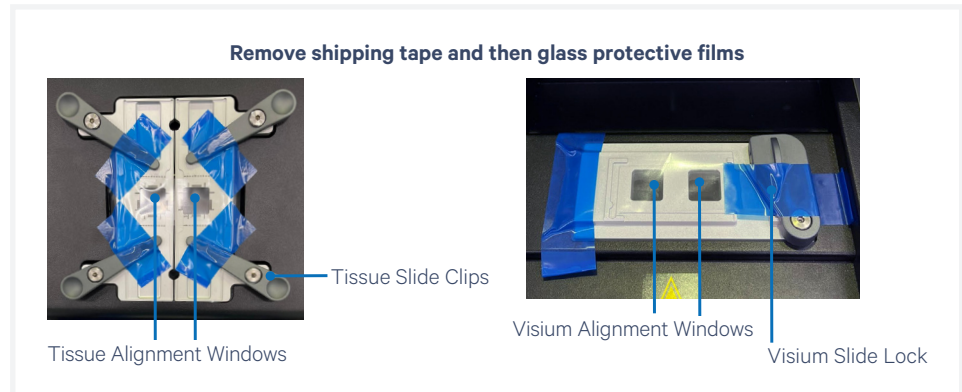

- g. Within the Instrument Accessory Kit box, locate the universal power cord and plug adapters. Attach the correct country adapter to the universal adapter.
- h. Plug the Visium CytAssist into a properly grounded outlet of proper voltage (see [Product Specifications](#)). If using an Ethernet cable (not provided) to connect to the network, connect cable directly to the instrument.



DO NOT power on yet.



Ensure power source is reliably grounded

Step 2: First-Time Use

The instrument will walk through a first-time setup protocol. Setup requires the following:

- **10x Genomics Account**
Onscreen instruction will guide account setup. Alternatively, visit cloud.10xgenomics.com/instruments to create an account beforehand.
- **Instrument serial number and instrument ID**
Located onscreen during setup, and also on the label at the back of the instrument
- **Network settings**
- **A computer with Internet access**
- **Network connection between instrument and 10x Cloud**
*An internet connection is required for firmware updates.
Wi-Fi configuration may not be available in your region. At present, only 5 GHz Wi-Fi connections are supported.
Ethernet is recommended for optimal performance.
See the [10x Genomics Cloud](#) section in *Tips & Best Practices* for more information.*

Turn on the System

- a. Power on the instrument using the power switch at the back of the unit.
If using Ethernet, connect the cable to the instrument Ethernet port.
- b. Follow onscreen instruction for Network Setup (via ethernet or Wi-Fi).
Refer to the [CytAssist Network Connectivity Technical Note \(CG000653\)](#) for more details.

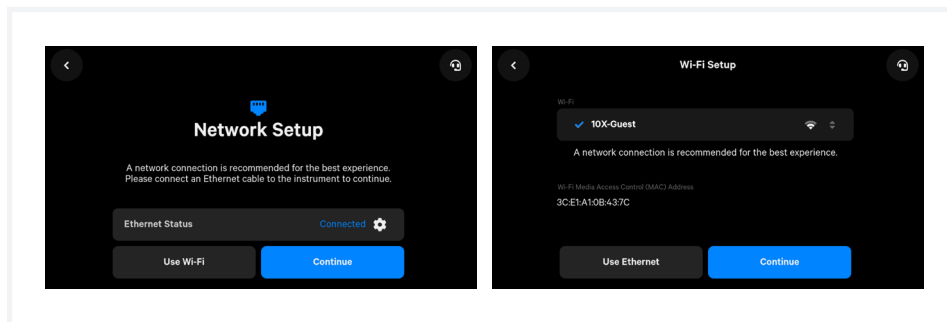

- c. Set the Date and Time.

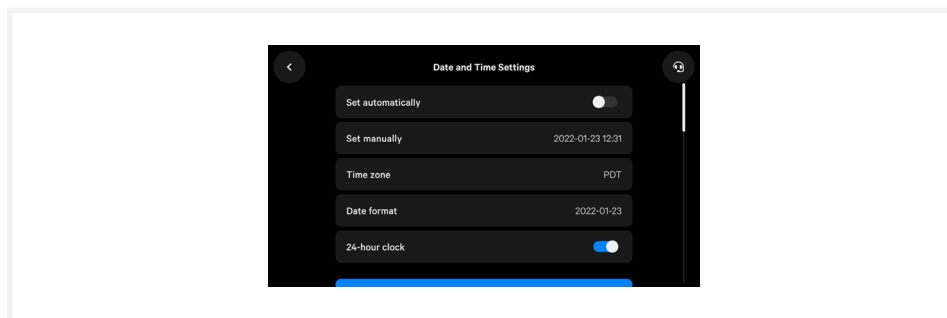

Step 2:
First-Time Use
contd.

d. Register the instrument.

Navigate to register.10xgenomics.com using the onscreen QR code or an internet-connected device. Create or log in to a 10x Genomics account. Enter the serial number + instrument ID found on the instrument screen. Read and accept the legal agreement.

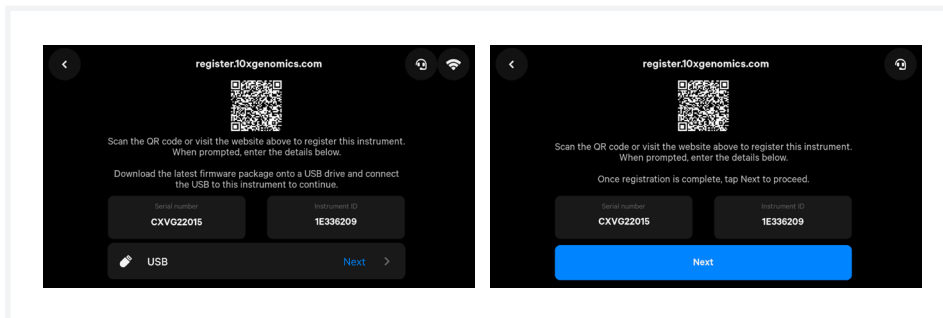

e. Update the firmware.

After registration, the instrument will automatically search for the latest firmware update. Confirm settings for instrument diagnostics and automatic firmware download.

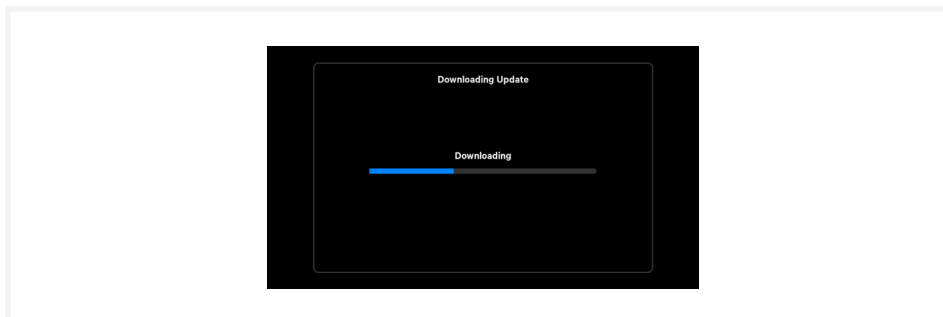

After the instrument updates, a recommended configuration screen will appear. On this screen, the ability of the instrument to automatically upload diagnostic data as well as automatically download updates can be adjusted. 10x Genomics recommends keeping these settings on. These settings can be changed later.

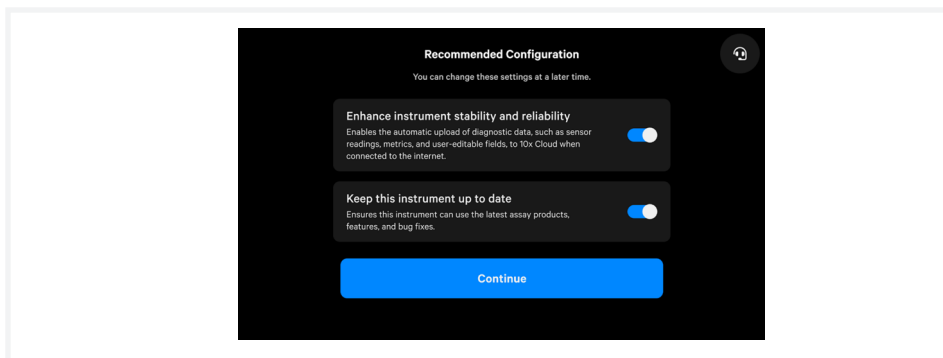

Step 2:
First-Time Use
contd.

If either setting is turned off, the following warnings will appear:

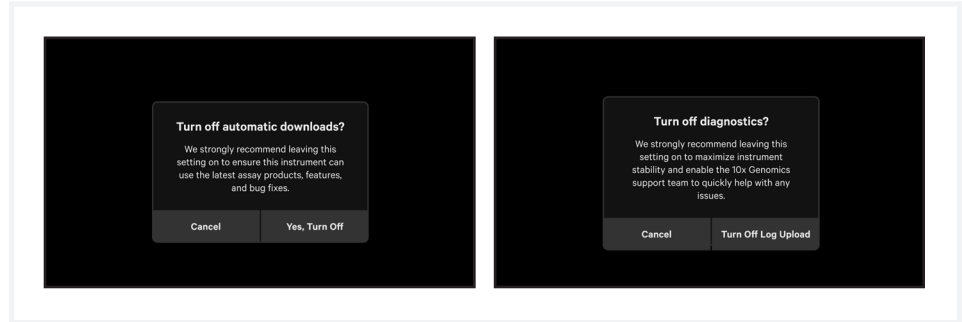

See the [Firmware Update Procedure](#) section for more details.

- f. Proceed to Leveling Mode. The level status of the instrument should only be verified or adjusted in Leveling Mode during First Time Use setup or after relocation of the instrument. To level the instrument, turn the adjustable feet at the front of the instrument. Adjust left-right tilt first by adjusting one foot at a time, then adjust the front back tilt using both feet at the same time until both bars turn green.

DO NOT use any alternate methods to determine if the instrument is level. The instrument is intended to be leveled within an acceptable range.

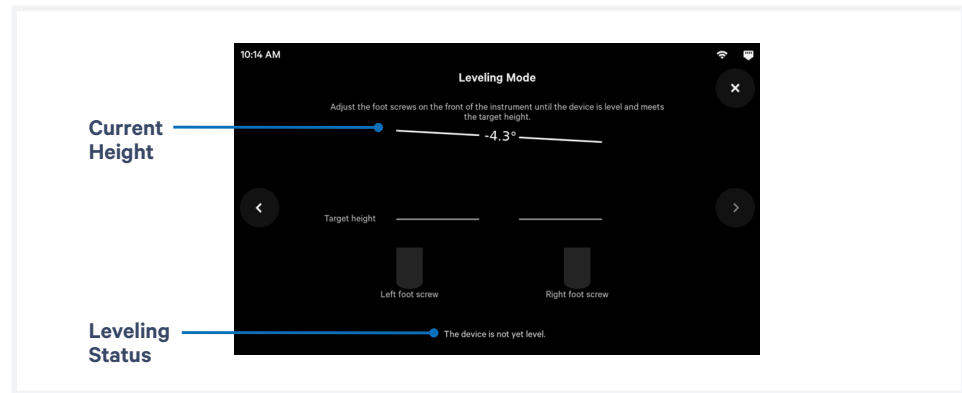

Turn feet clockwise for decreasing and counterclockwise for increasing height. The feet will come off the instrument if they continue to be turned counterclockwise.

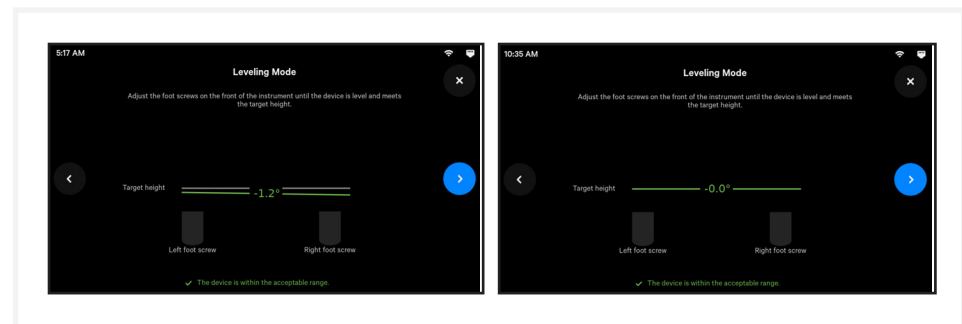

Step 2: First-Time Use contd.

Once the instrument is leveled correctly, check the back of the instrument to confirm that the center back non-adjustable foot is resting on the table top while the two non-adjustable corner back bumpers are not touching the table top.

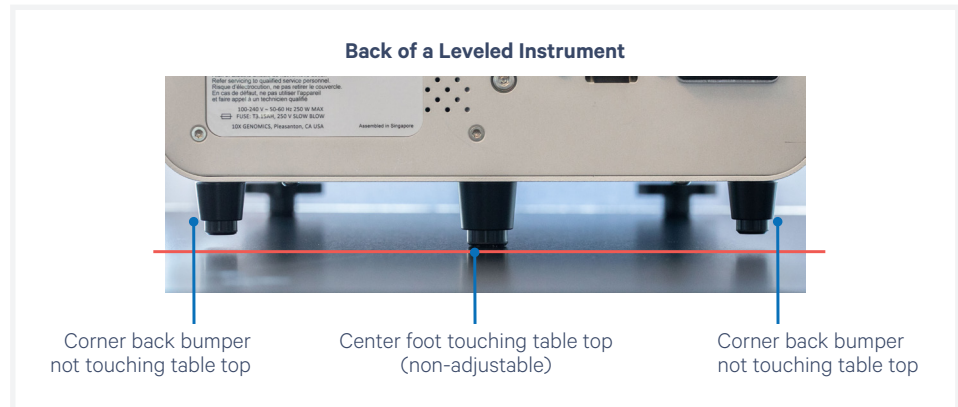

See [Troubleshooting](#) section if an error occurs during the first-time setup protocol.

Step 3: Readiness Test



Prior to running the Readiness test, ensure that the Shipping Bolt has been removed.

The Readiness Test calibrates the imaging parameters and verifies that all systems are working optimally. No reagents are used (the Readiness Test is the only dry run the instrument utilizes). Wear gloves when performing the Readiness Test.

- a. During first-time setup, follow onscreen instruction to launch the Readiness Test (~40 min).

To initiate a Readiness Test at any other time, navigate through the menu to System > Alternate Modes > Readiness Test.

OR press the blue Run Start Button to initiate a run. Enter the Readiness Test serial number (located on the Visium Calibration Slide label).

See [Barcode Scanner](#) section in [Tips & Best Practices](#) to use a scanner instead of entering manually.

- b. Locate the two blank slides and the Visium Calibration Slide in the Instrument Accessory Kit. Inspect for any chips or cracks. Calibration slide may be cleaned with lens paper or laboratory wipes followed by forced air. Dirty slides may cause the readiness test to fail.



- c. Enter the serial number on the calibration slide (using a different serial number could result in poor calibration).

See [Barcode Scanner](#) section in [Tips & Best Practices](#) to use a scanner instead of entering manually.

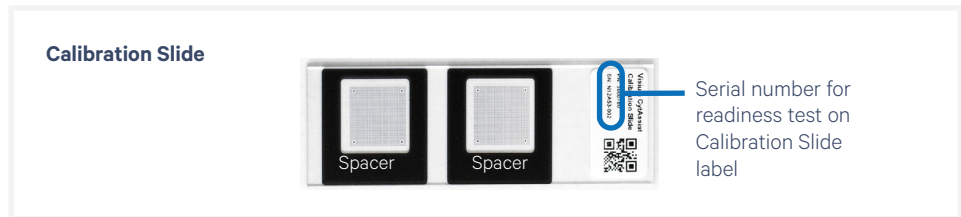

- d. Open the instrument lid.
- e. Follow onscreen instruction and load the blank slides and calibration slide onto the instrument, as described in the [Tips and Best Practices](#) section. **DO NOT** load reagents to the calibration slide for the Readiness Test.
- f. Press the blue play button to start the test.

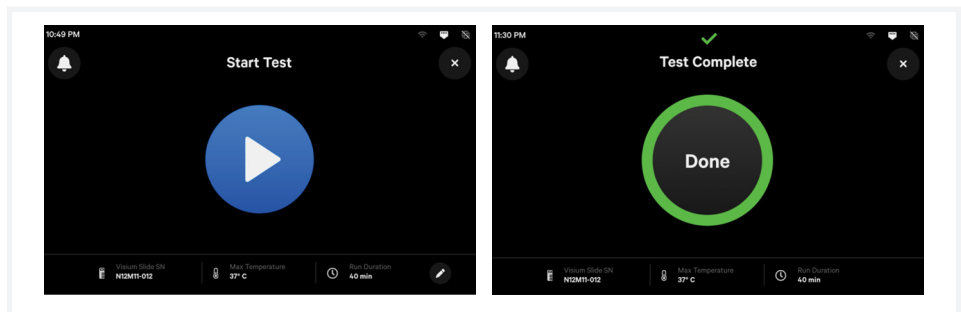

- g. A successful Readiness Test marks the end of setup. Follow onscreen instruction in the event of a failed or incomplete test.

Step 3: Readiness Test *contd.*

Clean Up After a Readiness Test

- h. Upon test completion, open the lid and unload the blank slides and calibration slides. Calibration slide may be cleaned with lens paper or laboratory wipes followed by forced air.
- i. Store the blank slides and the calibration slide away from sunlight and extreme temperature, in the original packaging bag. Retain for future use.

The Visium Slide Stage of the Visium CytAssist has been designed to catch and contain drips and a small volume of liquid spills. If lab safety guidelines permit, a soft lab towel may be used to clean these areas with a mixture of mild detergent and distilled water. The external instrument surfaces and slide stages can tolerate periodic additional cleaning with a 10% bleach solution followed by a 70% ethanol or 70% isopropanol wash. Follow the relevant lab safety requirements when cleaning the CytAssist instrument.

Clean glass windows with dry polyester swabs (such as Texwipe TX714A Cleanroom Swab, 0.5"L - EW-33677-62 from Cole-Parmer or equivalent). Use a bright light (e.g. flashlight) to inspect the glass windows for any smudges and remove them as described above.

See [Maintenance](#) section for more details.



Do not spray the instrument directly with ethanol or bleach.

- j. Close the lid (clicking sound indicates closure; always store the instrument with the lid closed). Wipe down the base and lid of the instrument.
- k. The instrument is now ready for use.

For optimal performance, a Readiness Test is recommended at the following times:

- During first-time use
- After any firmware update
- After moving the instrument



The instrument requires a ~20 min cool down between runs.

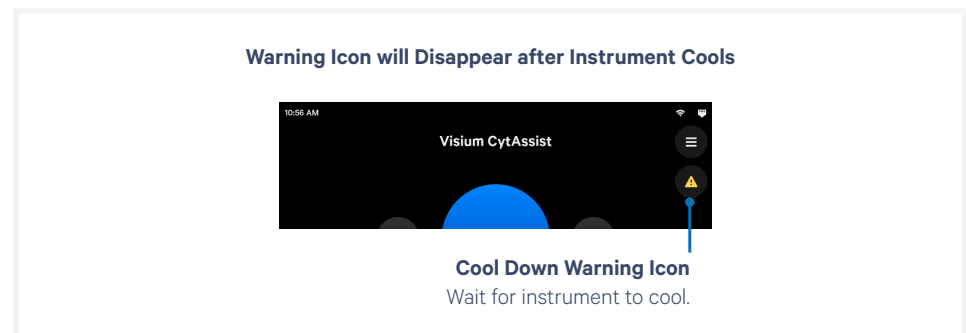

Step 4: Main Operation

The run-ready screen is the most common state of the instrument. There are several key functions accessible directly from the home screen.

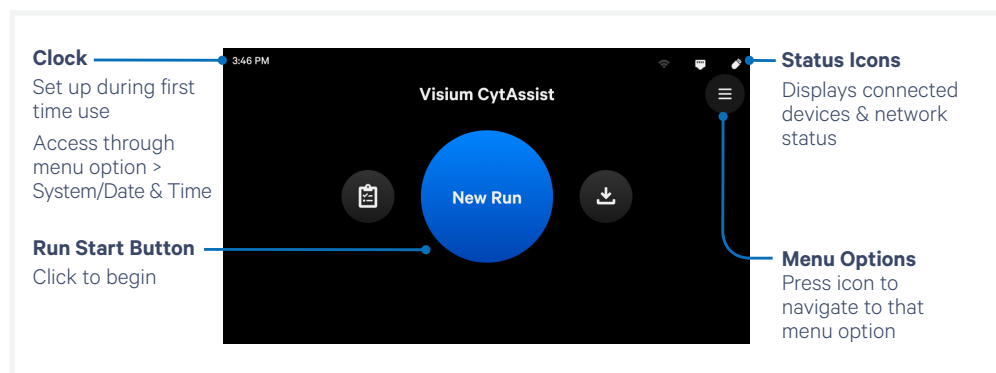

Main Operation Overview



This section is meant as a general overview of instrument operation and its placement within the steps of the Visium CytAssist-enabled assay. When performing the protocol, follow the steps listed in the appropriate assay kit user guide and use this section only as a reference.

Before proceeding with the appropriate Visium CytAssist-enabled assay:

Select two tissue slides containing sections of interest, and verify that the tissue section is located in an area that results in successful analyte-derived molecule transfer and imaging. Overlay the slides on the diagrams in the [Tips & Best Practices](#), or in the Visium CytAssist Quick Reference Cards – for Accessory Kit Instruction (CG000548), located in the Instrument Accessory Kit.

If only one tissue on one slide will be loaded, use a blank slide for the second position on the Tissue Slide Stage.

Follow the protocol in the appropriate assay kit user guide for preliminary steps and preparation prior to and during use of the Visium CytAssist instrument.

- a. Gather two tissue slides, the appropriate Visium Slide and reagents as listed in the appropriate assay kit user guide.
- b. Enter new run information, including:

- Visium Slide serial number

See [Barcode Scanner](#) section in [Tips & Best Practices](#) to use a scanner instead of entering manually.

On the Run Configuration screen, editing the the serial number is limited—the first digits (that indicate slide type) cannot be changed. This prevents the instrument from running a program incompatible with the slide type. In order to input a different full serial number, exit the Run Configuration screen, return to the “New Run” home screen, and start over.

Step 4:
Main Operation
contd.

- Any change from default temperature and time (37 °C for 30 min)
 See the appropriate assay kit user guide for further guidance.
- Sample names; the 6.5 mm Capture Areas are designated A1 and D1. The 11 mm Capture Areas are designated A and B.

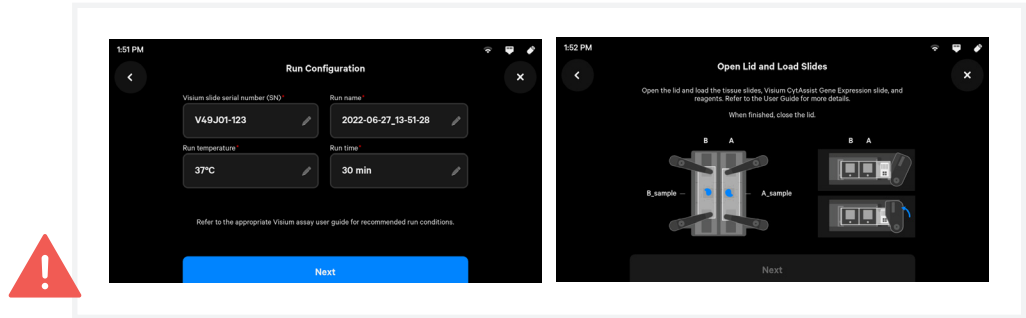

c. Open lid.



- d. Follow onscreen instruction and load the tissue slides and Visium Slide onto the instrument, as described in the [Tips and Best Practices](#) section.
- e. Load reagents to the circular dispensing well on each spacer when instructed in the appropriate assay kit user guide (be mindful of time-sensitive reagents).

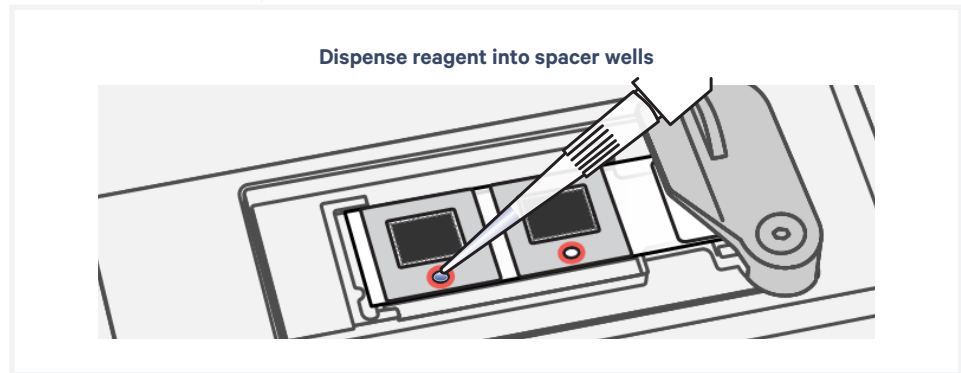

f. Close the lid (clicking sound indicates closure).



Pinch risk: Ensure no obstructions or fingers present when closing lid.

The home screen will now display a play symbol and run information along the bottom of the screen. (Use button in upper right corner of the screen to abort).

Step 4: Main Operation

contd.

- g. Press the play button to start the run.
- Midrun progress bar will show the time remaining in the run.
 - Yellow before a run begins indicates a user-recoverable error (see [Troubleshooting](#)).

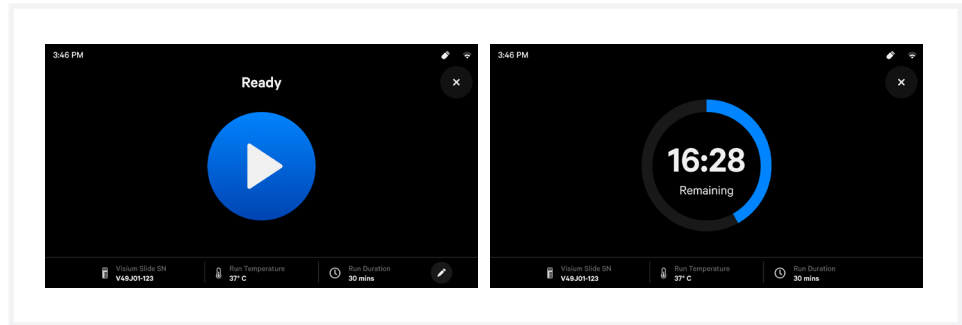

- h. At the end of a run, the button will display “Done” and a “Run Info” tab at the bottom of the screen.
- Green indicates a successfully completed run.
 - Red indicates a failed run/error (see [Troubleshooting](#)).
 - Yellow indicates that the run has been canceled.

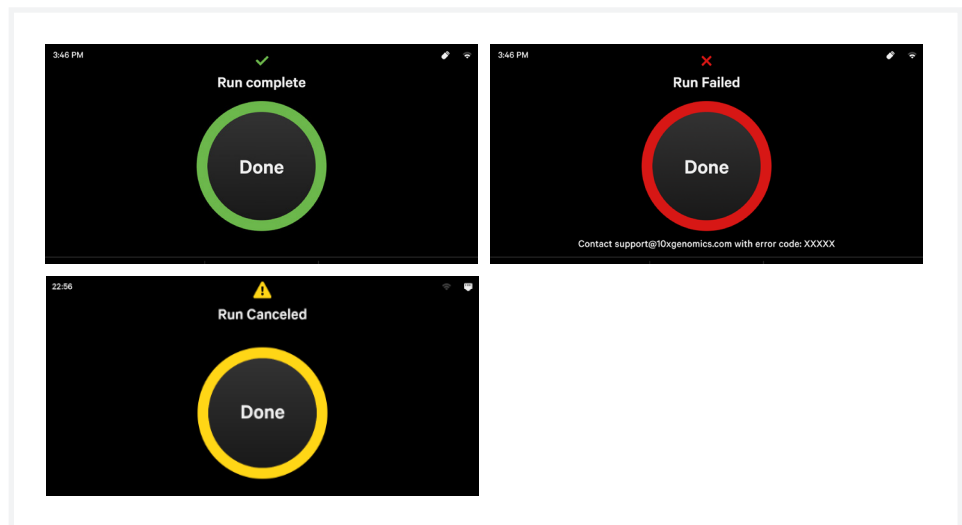

- i. Click the “Done” button and open lid. DO NOT power off the instrument at this time, as it needs to process support data.
-  j. IMMEDIATELY remove the Visium slide from the instrument, and proceed with the protocol workflow as specified in the appropriate assay kit user guide (save cleanup for later).

Step 4: Main Operation contd.

During the next stopping point in the workflow:

- k. Clean the instrument after every run. See [Maintenance](#) section for further guidance.
- l. Export the run data via USB or Network Shared Folder. See [Run Data and Network Shared Folder](#) sections for further guidance.
- m. View and verify the tissue samples were accurately aligned within the Visium CytAssist Slide fiducial frame. See the relevant assay kit user guide for further guidance.



The instrument requires a ~20 min cool down between runs. The warning icon will disappear once instrument is cool.

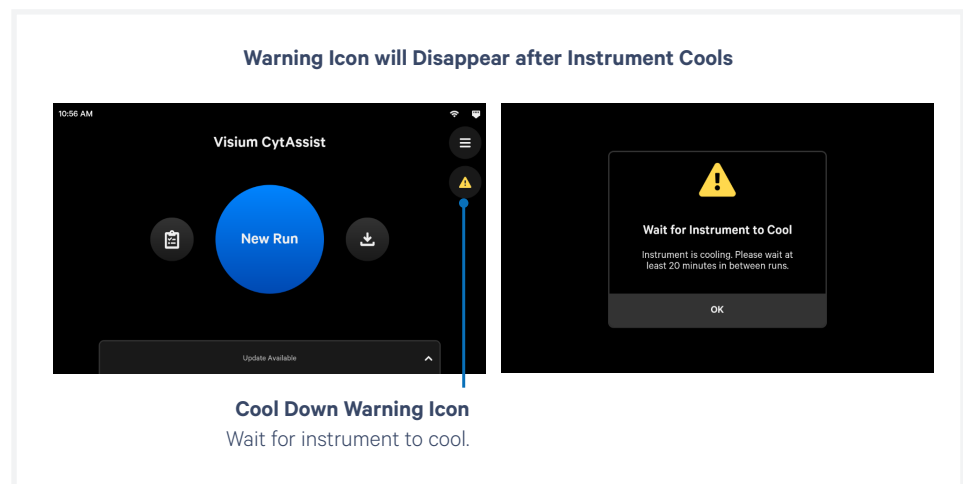



Menu Options

Menu Options

Firmware Update Procedure

Network Shared Folder

Menu Options

The instrument home screen enables starting a run, monitoring run progress, and accessing the Menu Options (top right corner of the screen) for Logs, Connectivity, and System information.

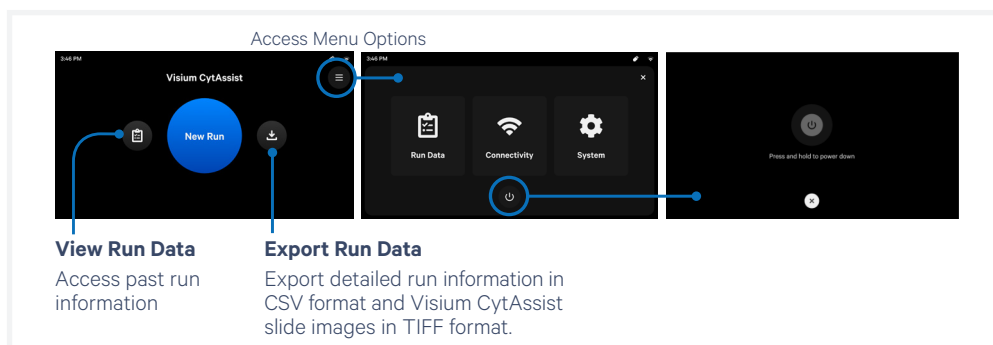

View Run Data

Access past run information

Export Run Data

Export detailed run information in CSV format and Visium CytAssist slide images in TIFF format.

The instrument's screen will dim after 30 seconds of inactivity. Power off the instrument by tapping the power icon at the bottom of the menu options screen. The system will go into a soft power down (screen is dimmed and displays time and name of instrument). Keep the instrument powered and networked when not in use.

To shut down the instrument completely, place the instrument in the soft power down state and then flip the power switch at the back (no preliminary steps needed before a complete shutdown). See [Moving & Shipping the Instrument](#) section.

Instrument Run Data

From this menu option, access and export:

- Run Data - includes CytAssist images, run csv with metadata (such as sample, run name, slide serial number etc.); Size ~10s of mb/run
- Support Package - includes Run Data plus instrument telemetry and sensor information (captured both during instrument run and instrument idle time); Size ~100s of mb/run
 - Idle time data, also known as system logs, are instrument-specific logs that are not related to runs.
- During First Time Use (FTU), the idle time data can be exported via USB or network shared folder by clicking the help (headset) icon on the top right corner of the screen.
- If the instrument is not performing a run, the idle time data can also be exported by navigating to Menu > System > Help and pressing "Send System Logs to Technical Support".

Share a Support Package with 10x Genomics Technical Support for troubleshooting purposes.

Menu Options

contd.

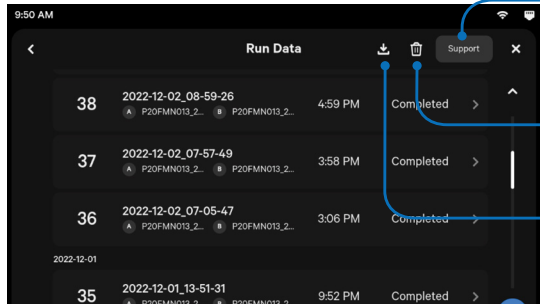

Upload to Support
Upload Support Package to 10x Genomics (with network connection) or to USB

Delete
Delete Run Data when it is no longer needed on the instrument.

Export
Export detailed run information in CSV format and Visium CytAssist slide images in TIFF format.

Data export ranges in size from 10s to 100s of MB, depending on how many runs are selected. If Diagnostics is turned on, instrument and system data are automatically exported or uploaded after a run for use in troubleshooting. CytAssist images are not exported as part of Diagnostics.



Immediately proceed to the next stage of the workflow in the assay kit user guide. While run images are needed for downstream analysis, **DO NOT** delay proceeding to the next workflow step. Data may be exported after reaching a safe stopping point in the assay workflow.

Export Procedure for Run Data

- a. Click the Download button on the home screen or Run Data page.

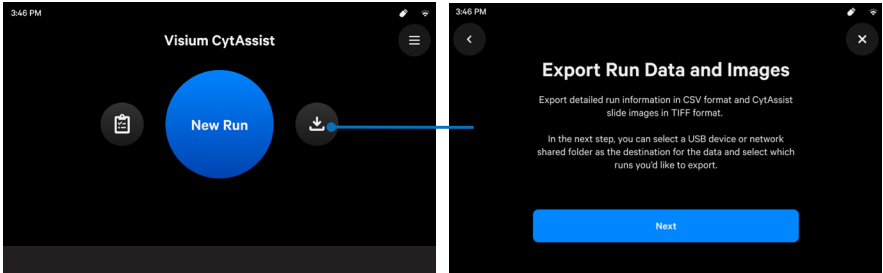

- b. Select a location to export Run Data. Runs can be exported to a USB drive or to a configured Network Shared Folder. See [Network Shared Folder](#) section for further guidance.

Menu Options *contd.*

- c. Select runs for export, then click Start Export. A progress bar will show the export status.

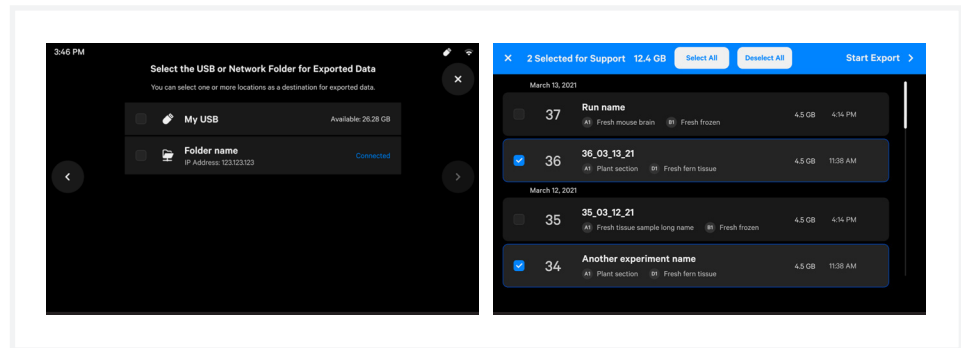

- d. Once export is complete, the user will be redirected back the Run Data log screen.

Alternatively, clicking on the Run Data icon on the left side of the home screen allows the user to view runs first and click Download later from the upper right hand corner.

Export Procedure for Support Packages

- a. Support packages can be exported from the Run Data page by pressing the Support button.

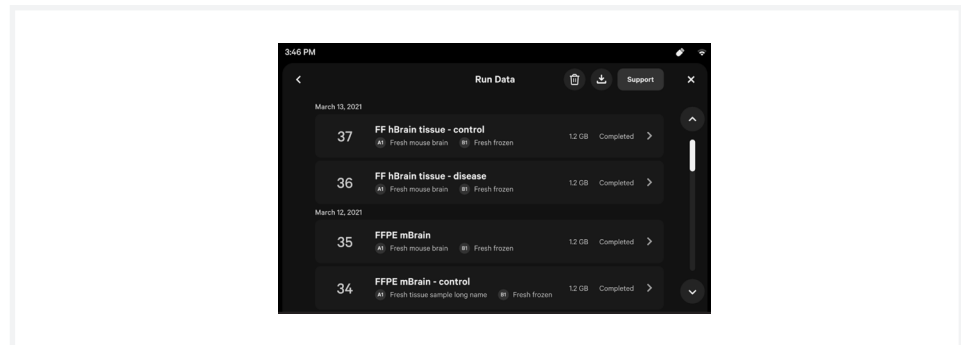

- b. Select a location to export support packages. Support packages can be exported directly to 10x Genomics support on instruments connected to the internet, to a USB drive, or to a configured Network Shared Folder.
- c. Select runs for export, then click Start Export. A progress bar will show the export status.
- d. Once export is complete, the screen will redirect back to Run Data.

To review service data with 10x Genomics Technical Support:

- Email support@10xgenomics.com with the instrument serial number and any applicable error codes.
- Upload pertinent logs directly to 10x Genomics Cloud with a network connection (preferred).

Support personnel can guide the user through these steps.

Menu Options

contd.

Deleting Run Data

The instrument stores up to 100 Run Data and up to 10 Support Data. The instrument does not automatically delete Run Data without user permission, while older Support Data is deleted automatically (oldest files are deleted first).

When data storage is full, a popup error message will inform the user to export and delete stored data before starting a new run.

- a. Export all important run data before permanently deleting.
- b. Navigate to Menu > Run Data.
- c. Click the trash can icon. Select individual runs or click Select All.
- d. Confirm Delete Data in the popup. A loading screen may appear while the instrument is deleting data.
- e. The screen will redirect back to Run Data. Deleted runs should no longer appear in the list.

Connectivity

Configure parameters for Wi-Fi, and Ethernet from this menu option. Note that Wi-Fi configuration may not be available in your region. At present, only 5 GHz Wi-Fi connections are supported. Ethernet is recommended for optimal performance.

The following connectivity icons may be found in the upper right corner of the screen (not visible during First Time Use setup):

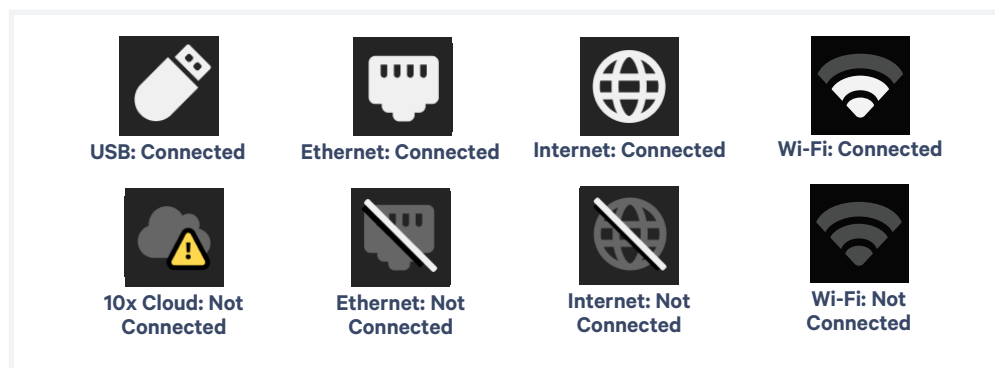

Click Diagnostics to enhance instrument stability and reliability. This enables the automatic transmission of diagnostic data, such as sensor readings, metrics, and user-editable fields to 10x Cloud when connected to the internet. To maximize internet stability and enable the 10x Genomics support team to quickly respond to issues, Diagnostics is enabled after software updates.

Menu Options

contd.

Network & Security

Allow outbound TCP port 443 for 10x Genomics Cloud access. As an additional (optional) level of security, the instrument can be put on its own network VLAN with Internet-only access.

For connectivity to work correctly, the network should allow unrestricted outbound access to the following hosts:

- `envoy.10xdevices.net`
- `envoy.10xgenomics.com`
- `10x-cloud-saas-instrument-assets.s3.us-west-2.amazonaws.com`

System

The system runs on a Linux platform. The instrument's hardware and firmware have been securely implemented to prevent modification and to only execute trusted 10x code. There is no end-user configuration or access to the internal hardware, OS, or applications.

In the System menu:

Locate information about this instrument such as serial number, instrument ID, and firmware version.

Change the date and time by country or time zone. Time can be set automatically via network connection. Toggle between 12-hour or 24-hour time.

Launch Shipping Mode (for safe instrument transportation) through the Alternate Modes menu option. See the Maintenance section, [Moving & Shipping the Instrument](#), for specific instructions on packaging the instrument.

Firmware update notifications will appear on the home screen when the instrument is connected to a network.

Firmware Update Procedure

Review the firmware update procedure below:

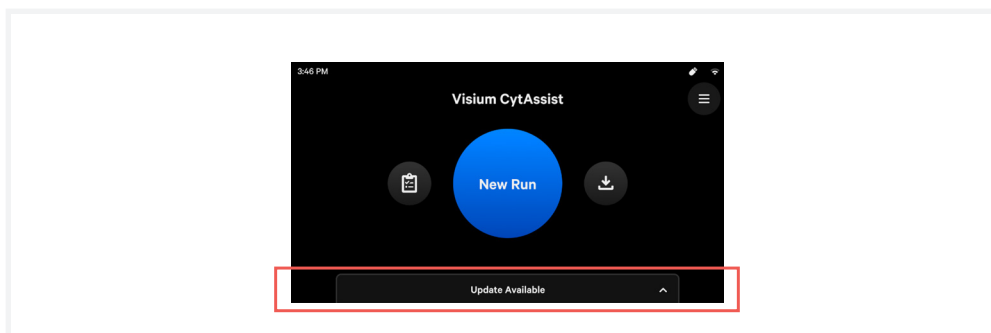

Step 1: Download and install the update

Procedure with an instrument connected to the internet and auto-download enabled (recommended):

Automatic downloads of updates are enabled after firmware updates to ensure the instrument is up-to-date with the latest assay products, features, and bug fixes.

- a. A pop-up on the home screen will alert the user of available updates.
- b. Open the pop-up and click to install.

Procedure with an instrument connected to the internet and auto-download disabled:

- a. A pop-up on the home screen will alert the user of available updates.
- b. Open pop-up and click to download.
- c. Once the update has been downloaded, install the update.

Step 2: Reinitialize the instrument

After installing an update, run a Readiness Test. See [Readiness Test](#) section for further guidance.

- a. To initiate a Readiness Test, navigate through the menu to System > Alternate Modes > Readiness Test. OR press the blue Run Start Button on the touchscreen. **Enter the serial number located on the Visium CytAssist Calibration Slide label.**

See [Barcode Scanner](#) section in [Tips & Best Practices](#) to use a scanner instead of entering manually.

- b. Locate two blank slides and the Visium CytAssist Calibration Slide in the Instrument Accessory Kit. Ensure slides are clean.
- c. Follow onscreen instruction and see [Tips and Best Practices](#) section to load the blank slides and calibration slide onto the instrument.
- d. Press the blue play button to start the test.
- e. Upon test completion, follow onscreen instruction to unload slides. Follow onscreen instruction in the event of a failed or incomplete test.

TIPS

Firmware Update Procedure

contd.

- f. Store the blank slides and the calibration slide in their original packaging bag, away from sunlight and extreme temperature. Retain for future use.
- g. The Visium Slide Stage of the Visium CytAssist has been designed to catch and contain drips and a small volume of liquid spills. If lab safety guidelines permit, a soft lab towel may be used to clean these areas with a mixture of mild detergent and distilled water. The external instrument surfaces and slide stages can tolerate periodic additional cleaning with a 10% bleach solution followed by a 70% ethanol or 70% isopropanol wash. Follow the relevant lab safety requirements when cleaning the CytAssist instrument.
- h. Clean glass windows with dry polyester swabs (such as Texwipe TX714A Cleanroom Swab, 0.5”L - EW-33677-62 from Cole-Parmer or equivalent). Use a bright light (e.g. flashlight) to inspect the glass windows for any smudges and remove them as described above.
See [Maintenance](#) section for more details.
- i. Close the lid (clicking sound indicates closure). Wipe down the base and lid of the instrument.
- j. The instrument is now ready for use.

Network Shared Folder

The Network Shared Folder (NSF) function enables the Visium CytAssist instrument to remotely transfer run data or support packages to a designated storage location over a network connection. Consult an IT professional to assist in setting up the NSF function.

To use Visium CytAssist's NSF functionality, the following items are required:

- The Visium CytAssist and file storage location are connected to the same network
- A storage location with sharing enabled
- Appropriately configured Visium CytAssist

Requirement 1

Network Connection

NSF functionality requires that the Visium CytAssist instrument and the machine hosting the file storage location be connected to the same network.

The network may be an internet connection or an intranet connection. An internet connection is an open connection which allows access to the world wide web. An intranet connection is a closed network, designed to limit access. Intranet connections are often used in business applications for a more secure exchange of information.

Requirement 2

Storage Location with Sharing Enabled

NSF works by connecting the Visium CytAssist to a designated storage location on a computer or server. To remotely transfer files from the Visium CytAssist directly to a NSF, the designated storage location must be configured with the appropriate sharing settings. The configuration process may differ between operating systems and storage location types. Use the following instructions to set up the sharing permissions on machines running the Windows 10 and MacOS 12.6 operating systems. If using an alternative operating system, find more information and guidance in the operating system's user guide or contact an IT professional.

Network Shared Folder

contd.

Windows 10 Destination Storage Location Configuration:

- Right-click on the folder that will receive data from the instrument.
- Select “Properties”.
- In the Properties window, select the “Sharing” tab and click on “Advanced Sharing”

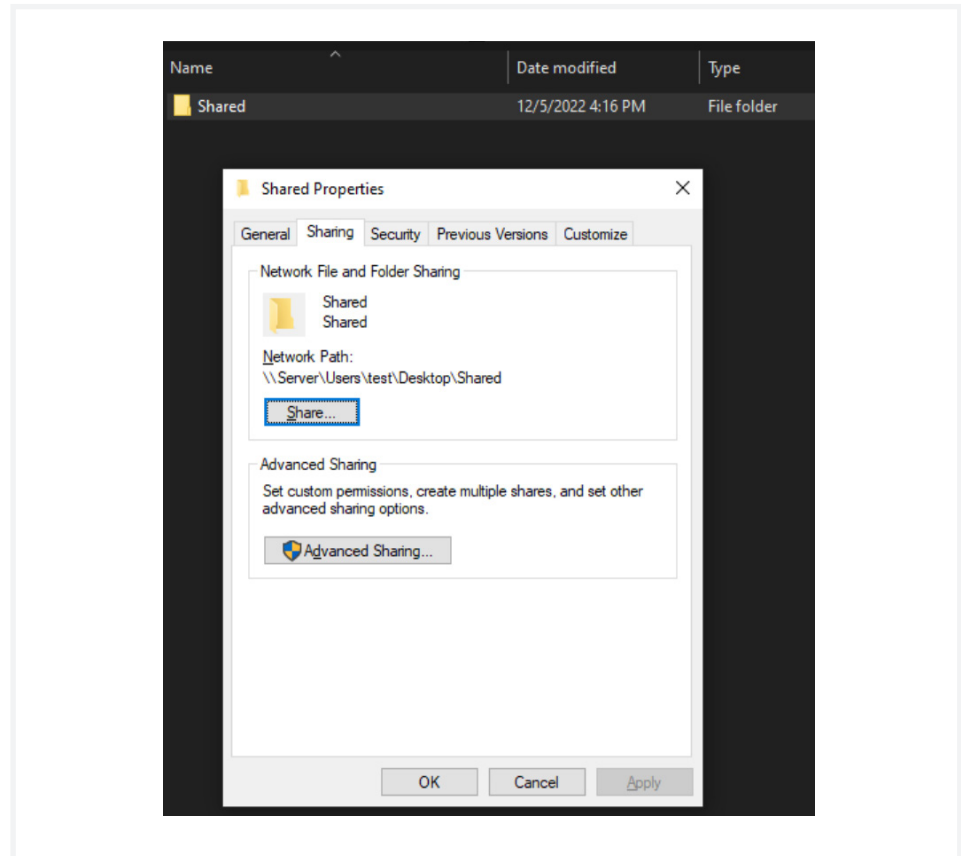

- If prompted with a User Account Control window, enter the user name and password.

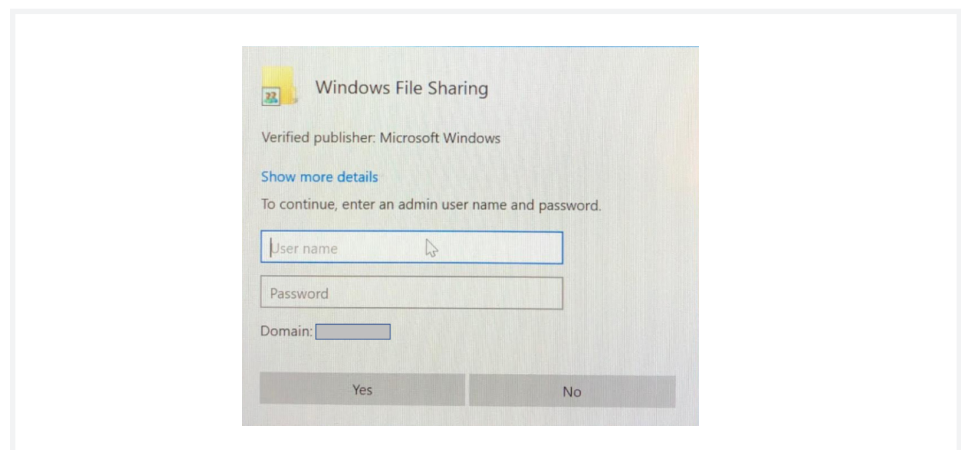

Network Shared Folder

contd.

- e. In the Advanced Sharing window, select “Share this folder” and click on “Permissions.”
- f. Add or remove users that should have access to the folder. Alternatively, add “Everyone” if access should not be restricted.
- g. After adding users, set permissions for each user to “allow” for both “Change” and “Read”.

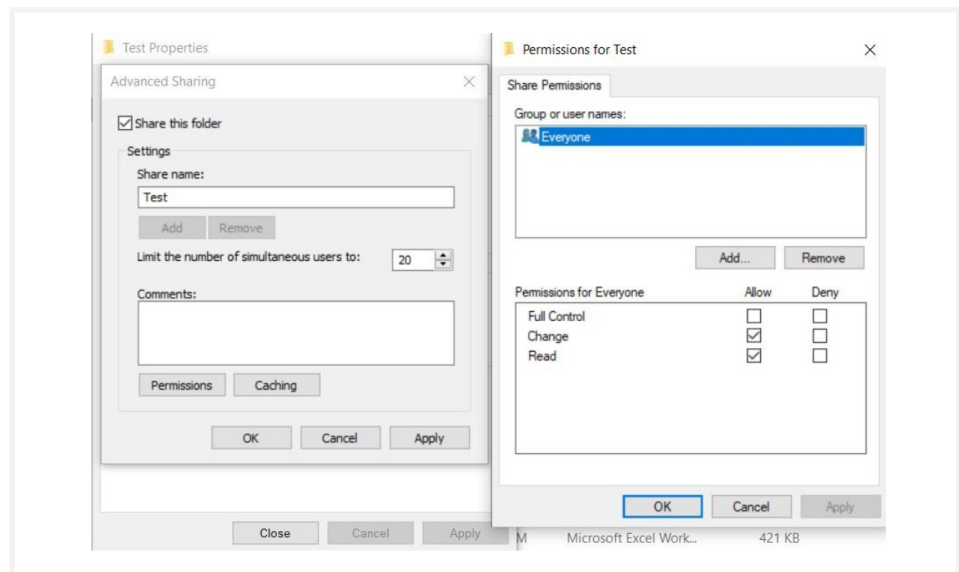

- h. Click on “OK” and record the shared folders name.
- i. Click on “OK”.
- j. In the Advanced Sharing window, click “Apply” to apply changes.
- k. Click on “OK”

Collecting the Windows 10 user Domain/Workgroup:

- a. Open the Command Prompt window by:
 - Pressing the Windows Key + R and entering `cmd` in the Run window
 - OR
 - Search for the Command Prompt Window within the Start Menu
- b. Type `systeminfo | findstr /B "Domain"` in the Command Prompt window and press enter.
- c. If not joined to a domain, “Domain:WORKGROUP” should appear. If anything besides WORKGROUP appears, a domain has already been joined. This domain name will be used later.

Network Shared Folder
contd.

MacOS Destination Storage Location Configuration:

- a. Navigate to Menu > System Preferences > Sharing.
- b. Turn on File Sharing.

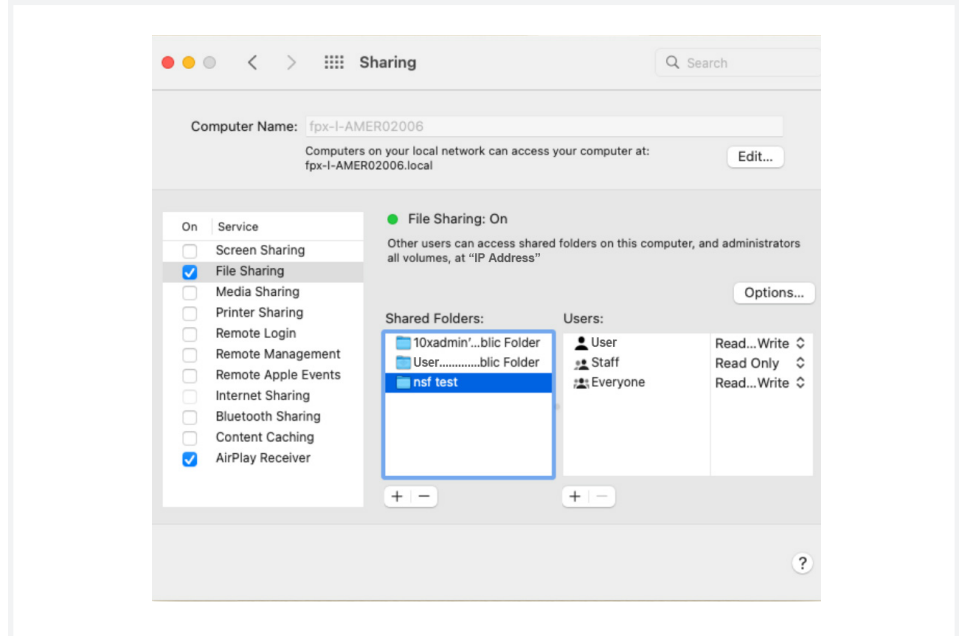

- c. Click on “Options”.
- d. Select “Share files and folders using SMB” and the checkbox next to the account of interest. If an Authenticate window appears, enter the password.
- e. Click on “Done”.

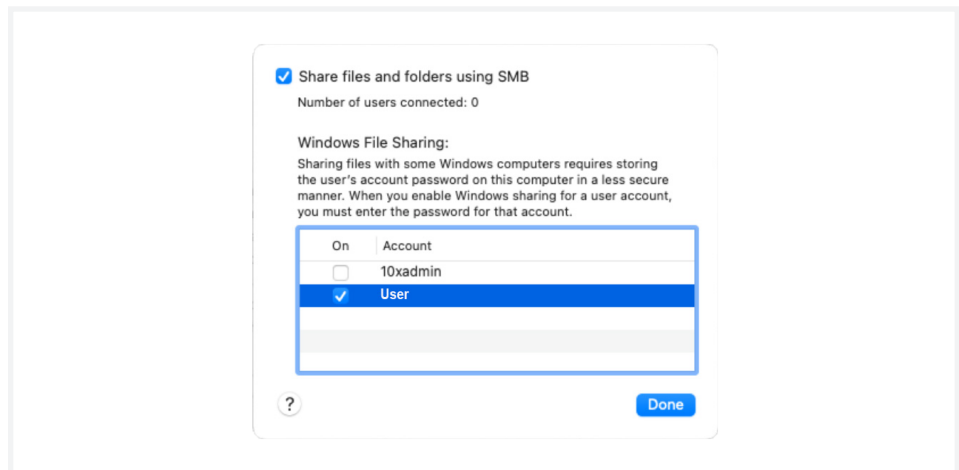

Network Shared Folder

contd.

- f. Click on the “+” below the Shared Folder list and select the folder that will receive data.
- g. Change the user permissions to “Read & Write”
- h. Record the IP address (see red box in image below).

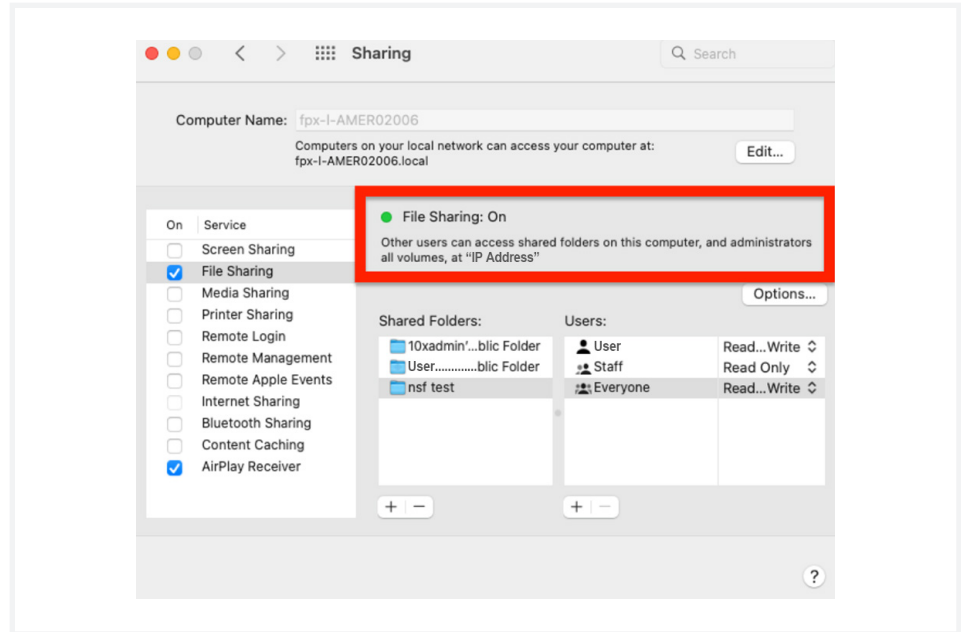

Collecting the MacOS user Domain/Workgroup:

- a. Open the terminal.
- b. Enter `open -a Directory\ Utility.app`.
- c. It may be necessary to unlock the Direct Utility window to make changes.
 - Unlock the window to make changes.

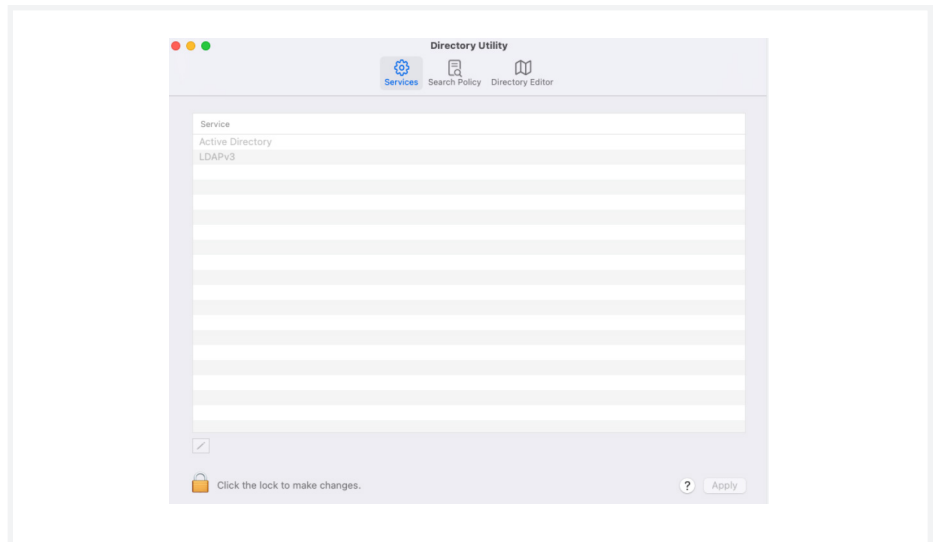

Network Shared Folder

contd.

- Enter the password for the Username that appears. Click “Modify Configuration”.

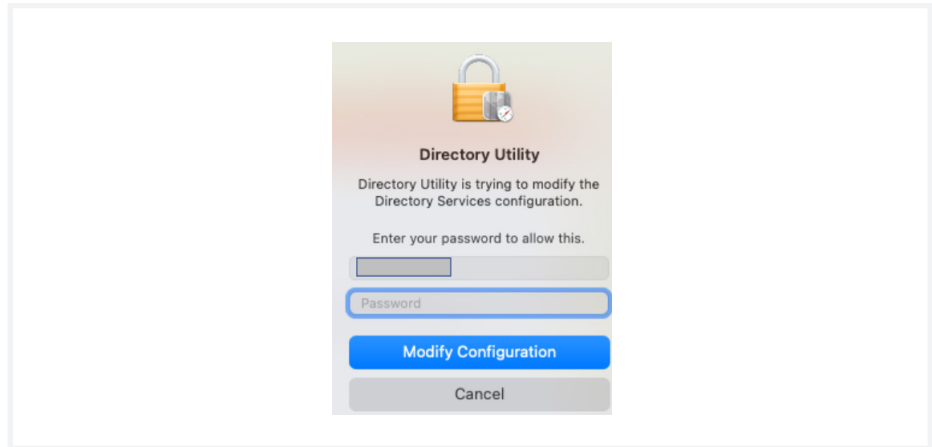

- d. In the Directory Utility window, select “Active Directory”.

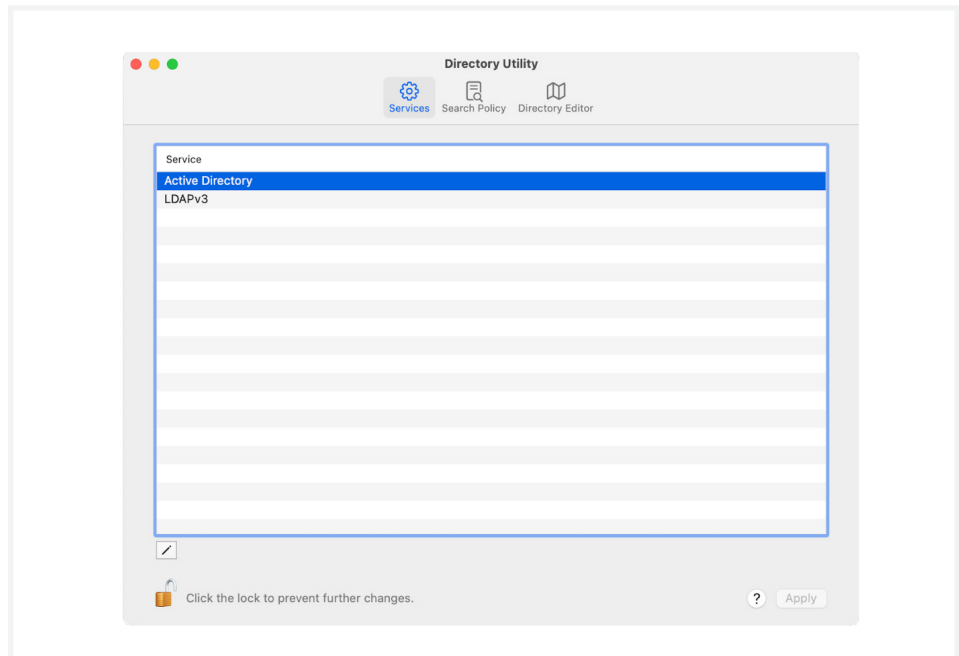

- e. The “Computer ID” contains the domain name. Consult an IT professional for naming format, as some computer IDs may contain more than one domain name.

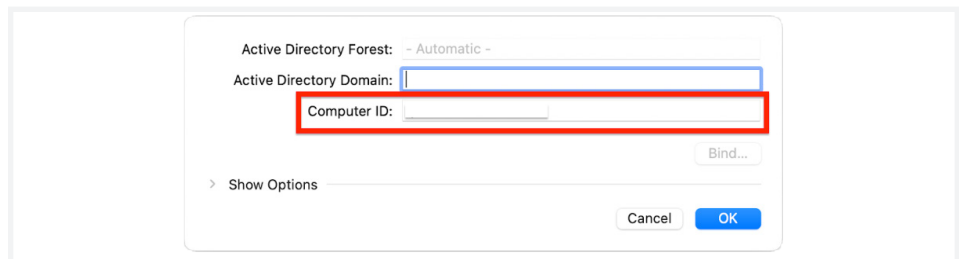

Network Shared Folder

contd.

Requirement 3

Appropriately Configured Visium CytAssist

The instrument currently supports connection to only one network mount. Follow the instructions below to configure the instrument.

Set Up New Share:

- Onscreen, navigate through the menu to Connectivity > Network Shared Folder.
- If configuring for the first time, press “Connect to a network shared folder” when prompted.

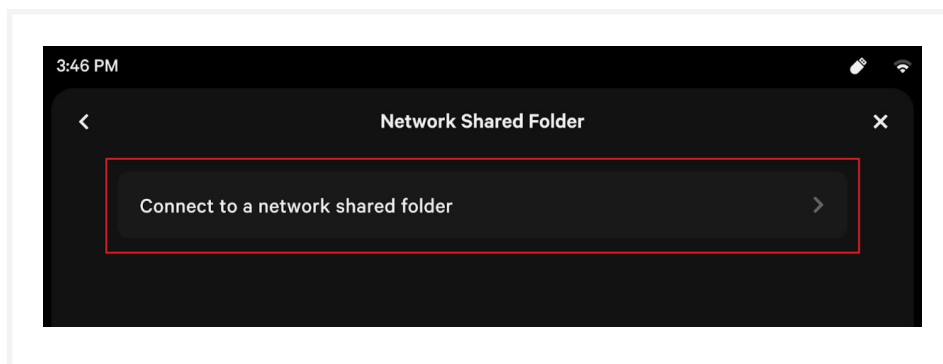

- Enter the information in the following fields:
 - **Folder name or path (required):** Enter the shared folder name or a path to a subfolder within the shared folder. The folder name or path needs to match the name of the folder on the designated data transfer location and only needs the path starting with the shared folder configured on the computer or server. For example, take a parent folder named “CytAssist” which contains subfolders named “RunData” and “SupportData”. If the parent folder, “CytAssist” is configured to be the designated location and the user intends to save files directly to the parent folder, the user may enter “CytAssist” in the Folder name or path field. If the user intends to send their run data to the RunData folder, then the user should add “CytAssist/RunData” in the Folder name or path field.
 - **Username:** User may enter the username on the computer for the account that has access to this folder. If this is a public folder without user restriction, this field can be left empty. For example, if the computer username during login is “John.Doe”, enter “John.Doe” in the username field.
 - **Domain:** User may enter the domain or workgroup for the account used to access the shared folder, if username is defined. This field becomes mandatory when username is defined.
 - **IP address (mandatory):** User must enter the IP address of the computer to connect to. For example: 192.168.0.10.

Network Shared Folder

contd.

To determine IP address on a computer running Windows 10:

- i. Open the Start menu and select “Settings”.
- ii. Select “Network & Internet”
- iii. Determine if you are connected to the internet via ethernet or WiFi
 - If on ethernet, select “Ethernet” and click on “Network Connection”
 - If on WiFi, select “WiFi” and click on “Advanced Settings”
- iv. The IP address will be listed as “IPv4 address”

Alternatively, the command prompt may be used to determine the IP address.

- i. Open the Command Prompt within the Start menu and type `cmd` in the search bar. If the search bar is not present, click on “Run”.
- ii. Type `ipconfig` into the Command Prompt or Run box.
- iii. The IP address will be listed as “IPv4”.

To determine IP address on a computer running MacOS 12:

- i. Open the menu and select “System Preferences”.
- ii. Click on “Network” in the System Preferences window.
- iii. Choose the network connection from the list.
- iv. The IP address is provided in the “status” section.

- **Password:** User may enter the password associated with the username input into the ‘Username’ field. This is required if your username has a password. The CytAssist is designed to keep the password encrypted using a dynamically generated instrument-specific key which is stored locally on the instrument. The CytAssist does not share or save passwords as plain text.

- d. Press “Connect”.

If connection is successful, return to the instrument home screen. If connection is unsuccessful, refer to the troubleshooting codes at the end of this section.

Network Shared Folder

contd.

Edit Network Shared Folder Configuration

Only one folder may be set up on the instrument at a time. If there is a need to change the designated folder, the configurations may be edited.

- a. Onscreen, navigate through the menu to Connectivity > Network Shared Folder.
- b. If a shared folder is configured, it should appear as a button with “Connected”, as shown below. Press “Connected” to edit.

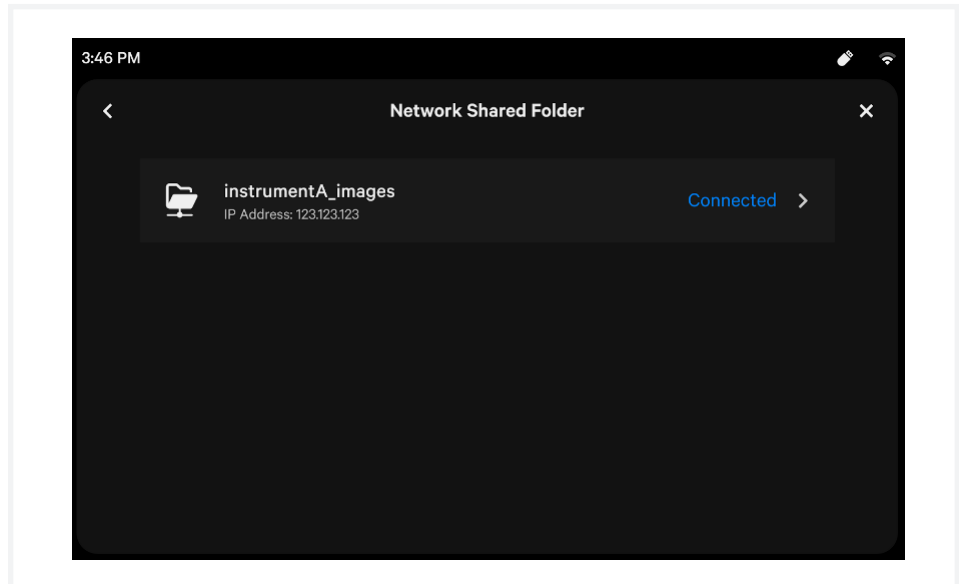

- c. Edit the desired fields and re-enter the password, if required.
- d. Press “Connect”. Once the connection is validated, the instrument will display the previous screen.

Network Shared Folder

contd.

Delete Network Shared Folder Configuration

- Onscreen, navigate through the menu to Connectivity > Network Shared Folder.

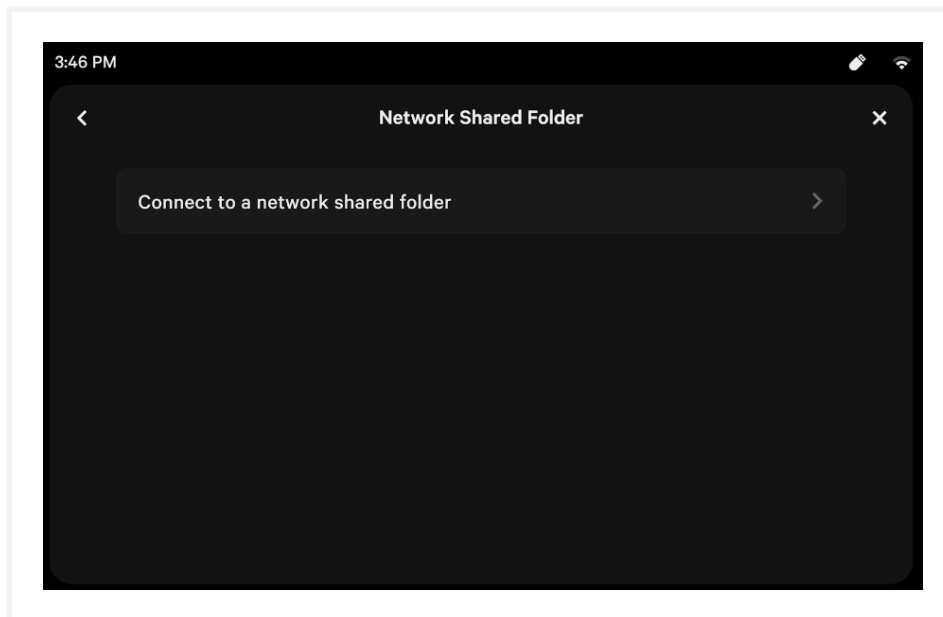

- If a shared folder is configured, it should appear as a button with "Connected", as shown above. Press "Connected" to edit.
- Press "Delete Connection".

The NSF screen should no longer display a folder name.

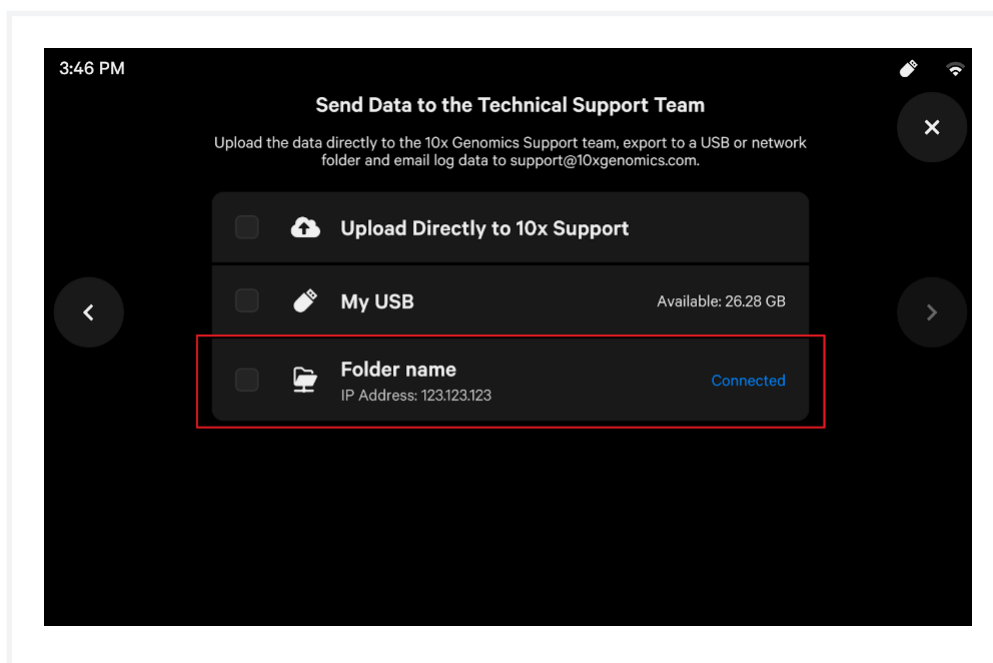

Exporting Data

After configuring a network shared folder, data can be exported to the designated folder during the standard log export workflow. During export, if the shared folder is available, it will display “Connected” on the right hand side and will be selectable. The instrument can export to multiple destinations at once.

Network Shared Folder Troubleshooting

Error	Possible Causes
EC-0141	<ul style="list-style-type: none">• Target destination for data not available on the network• Instrument not connected to a network• Shared folder does not exist
EC-0142	<ul style="list-style-type: none">• Incorrect Username• Incorrect Password• Incorrect Domain• Username provided doesn't have permission to access folder
EC-0143	<ul style="list-style-type: none">• If error is shown during export, ensure that the user has writing permission to the shared folder.

Due to the diversity of networking setups, it is not possible to cover all operating systems and network configurations in this User Guide. Please contact an IT professional or network professional for assistance when setting up the Visium CytAssist instrument or troubleshooting network issues.



Maintenance

System Maintenance

Moving & Shipping the Instrument

System Maintenance

Clean Up After a Run

- a. **After a Readiness Test or Training Run:** Open lid and store the blank slides and the calibration slide away from sunlight and extreme temperature, in the original packaging bag. Retain for future use. Proceed to step c.



After a Run: IMMEDIATELY open lid after a successfully completed run, remove Visium Slide from the instrument, and proceed with the protocol workflow. During the next stopping point in the workflow, proceed to step b.

- b. Dispose of tissue slides appropriately.
- c. The Visium Slide Stage of the Visium CytAssist has been designed to catch and contain drips and a small volume of liquid spills. If lab safety guidelines permit, a soft lab towel may be used to clean these areas with a mixture of mild detergent and distilled water. The external instrument surfaces and slide stages can tolerate periodic additional cleaning with a 10% bleach solution followed by a 70% ethanol or 70% isopropanol wash. Follow the relevant lab safety requirements when cleaning the CytAssist instrument.
- d. Clean glass windows with dry polyester swabs (such as Texwipe TX714A Cleanroom Swab, 0.5”L - EW-33677-62 from Cole-Parmer or equivalent). Use a bright light (e.g. flashlight) to inspect the glass windows for any smudges and remove them as described above.
- e. Close the lid (clicking sound indicates closure). Wipe down the base and lid of the instrument.

See [System Components](#) section for interior and exterior images

Interior

The Visium Slide Stage of the Visium CytAssist has been designed to catch and contain drips and a small volume of liquid spills. Occasionally, use a soft lab towel to clean these areas with a mixture of mild detergent and distilled water. For deeper, more thorough cleaning, it is acceptable to use a 10% bleach solution followed by a 70% ethanol or 70% isopropanol wash.



Do not use acetone or other harsh solvents. Apply all standard safety practices when using cleaners, and dispose of any generated waste in a responsible manner.

Exterior

The exterior of the Visium CytAssist should always be kept clean and free of dust and debris that may affect its function and/or cooling efficiency. Generally, the exterior finish can be wiped down using a mixture of mild detergent and distilled water applied to a slightly dampened lab towel. As an added precaution it is recommended that the instrument be unplugged from the power source before beginning any thorough cleaning process.

System Maintenance

contd.



Service

Electrical shock hazard. Do not open the Visium CytAssist in a manner not specified during standard operation. There are no user-serviceable parts inside. Refer all servicing to qualified 10x Genomics service personnel.

Servicing is required when the Visium CytAssist has been damaged in any way (e.g., a power entry module or plug is damaged, liquid was spilled into, or objects fell into the instrument, the instrument does not operate properly, or has been dropped).

Use only the power cord supplied with the Visium CytAssist. Do not replace it with a non-approved power cord as it may be inadequately rated to handle the electrical loads.

If replacing the externally accessible fuses in the power entry module becomes necessary, use only certified (EN60127 Sheet 5) 5 x 20 mm sized fuses rated T3.15AH, 250V Slow-Blow or equivalent.

When returning a Visium CytAssist for repair, take steps to ensure that the instrument has been decontaminated so as not to pose a hazard for 10x Genomics service personnel.

Environmental Requirements

It is the design intent of the Visium CytAssist that it be used in a typical indoor laboratory environment. The instrument's operating temperature is 18–28°C (64–82°F), humidity 80% Max (Non-Condensing) (see [Product Specifications](#)).

Moving & Shipping the Instrument

If the Visium CytAssist will be transported in a vehicle or shipped, it should be repackaged according to the instructions below. Run a new Readiness Test (see [Readiness Test](#) section) after relocating the instrument.

In the event of an instrument return to 10x Genomics, Support will guide the user through the correct documentation, in addition to the packaging procedure below.

Step 1: Shipping Mode

- a. Launch Shipping Mode (for safe instrument transportation).

Menu Options > System > Alternate Modes > Shipping Mode



- b. Once Shipping Mode is active, follow onscreen instruction to power down the instrument.
- c. Turn off the instrument completely using the power switch on the back of the instrument.
- d. Remove the power cord.
- e. Decontaminate the instrument (see [System Maintenance](#) section).

Step 2: Packaging Instructions

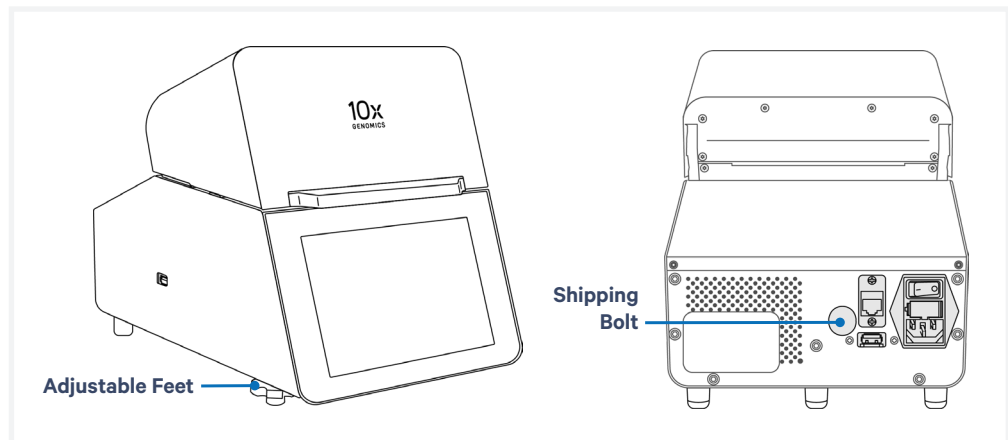

- a. Fully tighten the two adjustable feet at the front of the instrument by turning them clockwise.
- b. Retrieve the Shipping Bolt from storage. Insert and tighten the Shipping Bolt at the back of the instrument (the Shipping Bolt holds the camera focus in a safe position during transportation).
- c. Open lid. Apply glass protective film or laboratory labeling tape to the Visium and Tissue Alignment Windows (placement indicated by red dashed line in the illustration below).
- d. Move the Visium Slide Lock to the closed position and tape down the Visium Slide Lock and also the opposite end to secure the protective film.

Moving & Shipping the Instrument
contd.

- e. Move the four Tissue Clips to their innermost positions and tape down. Ensure that the tape is placed over all four Tissue Slide Clips along with the overlap with all four corners of the protective film.

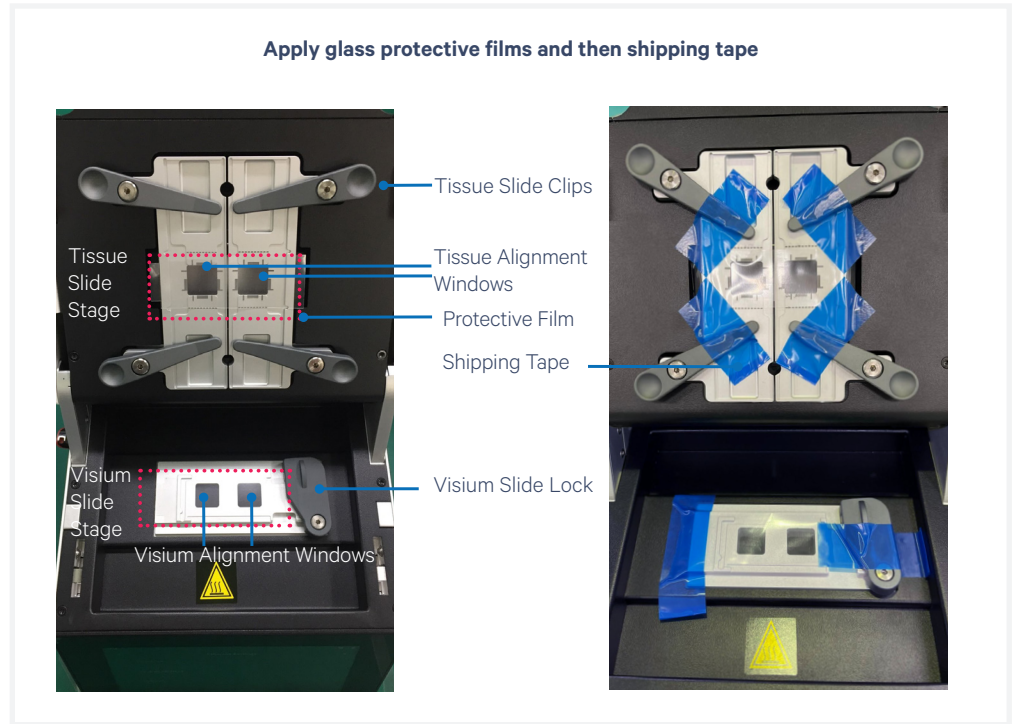

- f. Close lid. Apply laboratory labeling tape to one side of the base, across the top of the lid, and down the other side of the base (prevents the lid from opening during transport).
- g. Place the instrument within a plastic bag.

Moving & Shipping the Instrument

contd.

- h. Place the foam packaging base within the box. The arrow on the foam indicates the front of the instrument. Insert the instrument, lifting from the sides. Place the foam packaging on top of the instrument.
- i. Unless directed otherwise, do not include any parts of the Accessory Kit (which includes the power cord).
- j. Coordinate with 10x Genomics Support for further return instructions (some required paperwork will be placed in the box). Place the required documents into the box.
- k. Seal the box, and apply the shipping label.
- l. The instrument is now ready for transportation.

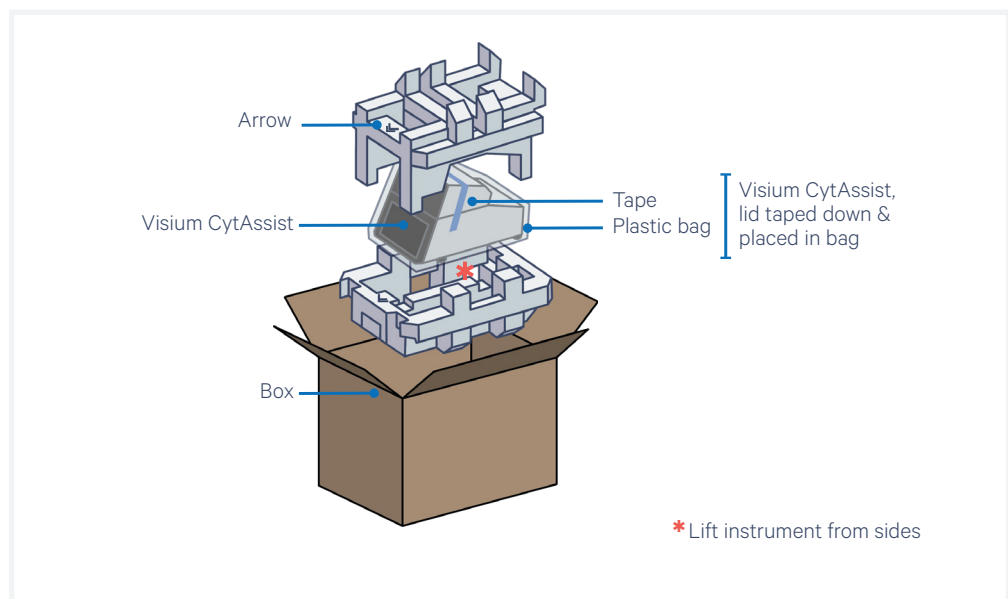

Troubleshooting

Troubleshooting

Error Screens



Troubleshooting

Issue

- **Visium slide loaded incorrectly**, resulting in slide breakage. Ensure that the slide sits within the grooves of the Visium Slide Stage, with the label facing toward the right. The images below show the Visium Slide loaded correctly and incorrectly. In the event of slide breakage, remove all traces of broken glass to avoid damaging the the instrument.



Exercise caution when removing glass to prevent injury.

Visium Slide Stage is Loaded Correctly with One Slide



Slide fits inside the grooves.
Label on the right is partially obscured by the lock.
Capture areas line up with alignment windows.

INCORRECT

Slide does not fit inside the grooves.
Capture areas do not line up with alignment windows.

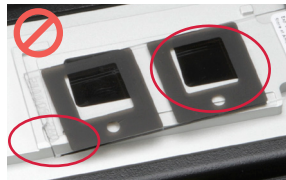

INCORRECT

Label is on the left.
Capture areas do not line up with alignment windows.



Slide is Broken due to Improper Loading

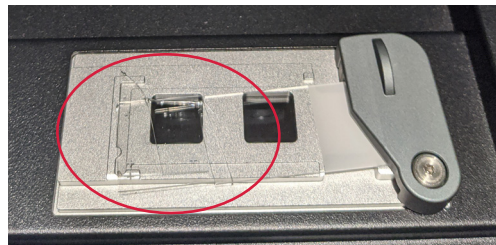

slide in image is representative

Troubleshooting

contd.

- Upon opening the lid after a successful run, the **Visium slide has popped out of the grooves** on the Visium Slide Stage. If the Visium slide was loaded on the Visium slide stage correctly prior to starting the run, this does not impact assay performance or slide quality.

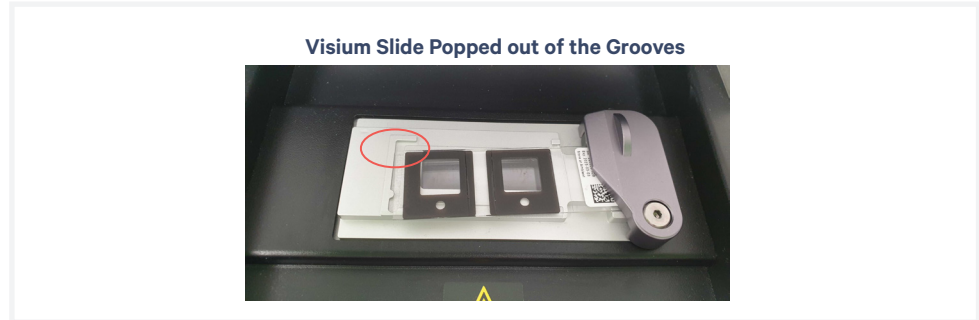

- **Debris is present on the Tissue Slide Stage or Visium Slide stage:** see [System Maintenance](#) section to clean the area.

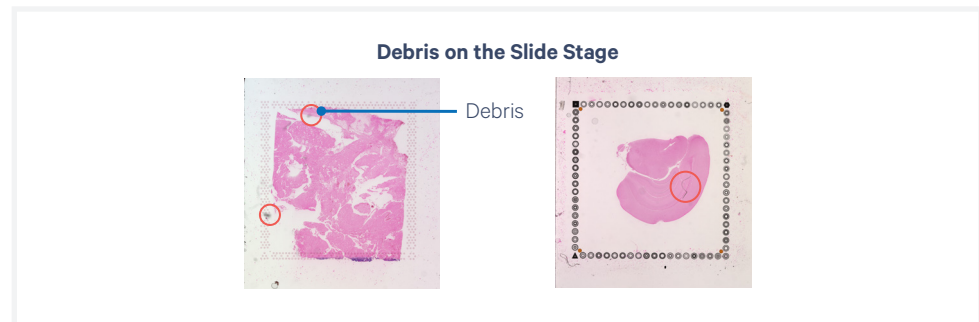

The images collected with Visium CytAssist are used for tissue-to-capture area alignment and image registration. The optical paths of all CytAssist instruments are inspected by 10x Genomics for the presence of dust/debris that may interfere with image collection or the image registration process. The inspections and the imaging processing algorithms have a designated tolerance for small amounts of visible dust. Debris that falls within the tolerance levels will not interfere with image processing. 10x Genomics cannot guarantee the absence of this type of debris on new units or over the lifespan of the instrument.

Troubleshooting

contd.

- **Bubbles near tissue on tissue slide:** if bubbles are outside of the tissue, the risk of affecting assay performance is low. If bubbles are on top of the tissue, it may result in lack of usable reads in the tissue area with the bubble.

Best practice: ensure reagent is prepared properly and correctly dispensed to the spacer wells to avoid introducing bubbles.



- **Instrument is not level:** To ensure the successful transfer of analyte-derived molecules to the Visium slide, it is important to keep the Visium CytAssist within an acceptable level range as compared to pre-calibrated values for the system. During the Leveling Mode process, the instrument uses built-in sensors to determine the system's orientation with respect to these pre-calibrated values. Proceed to Leveling Mode. The level status of the instrument should only be verified or adjusted in Leveling Mode during First Time Use setup or after relocation of the instrument. It is not expected for the instrument to be perfectly level, but rather within an acceptable range as indicated by the instrument's GUI (graphical user interface). Follow the instructions on the GUI to properly level the Visium CytAssist.

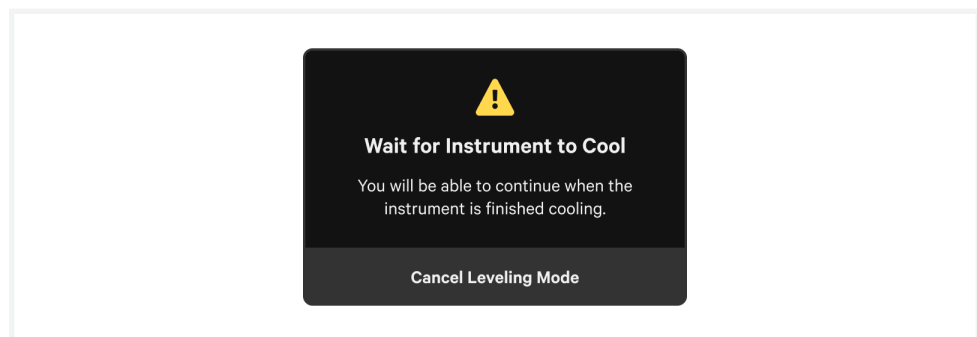

Troubleshooting

contd.

- **Instrument is hot:** If the Visium CytAssist overheats during an experiment run, the run will fail. A warning message will appear instructing users to carefully remove slides and contact support@10xgenomics.com

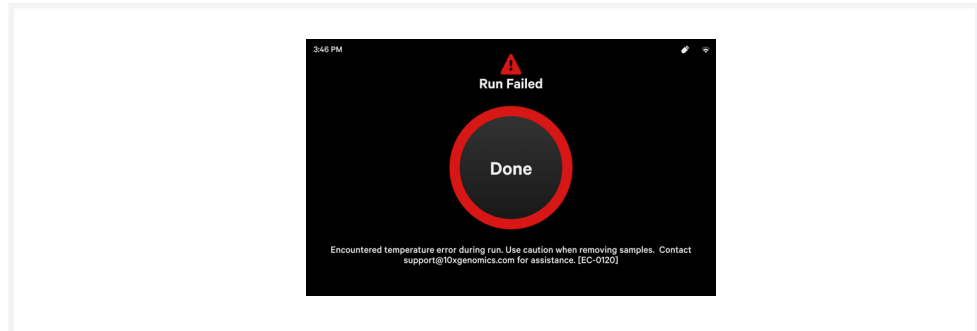

- **Poor tissue alignment on Visium CytAssist Slide:** Refer to the [Tips & Best Practices](#) section to verify tissue placement on a tissue slide. Practice using the Visium CytAssist Training Kit and User Guide (CG000549).

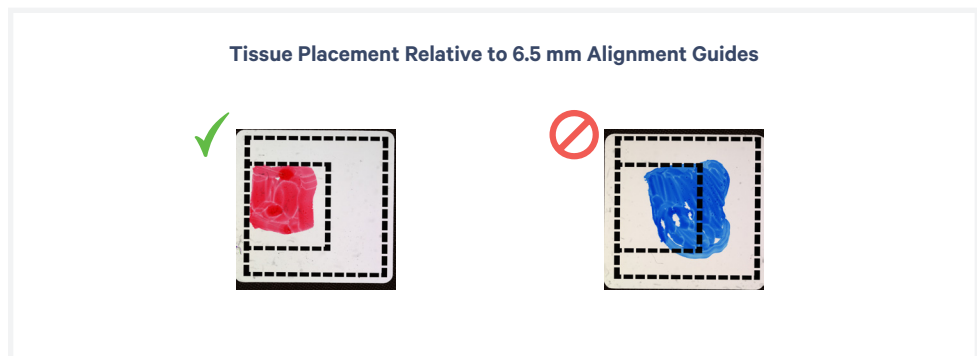

- **Readiness Test Fails:** During First Time Use, ensure that the shipping bolt has been removed from the back of the instrument. If shipping bolt was removed prior to error, power cycle the instrument. Next, refer to the [Maintenance](#) section and clean the instrument as described below.

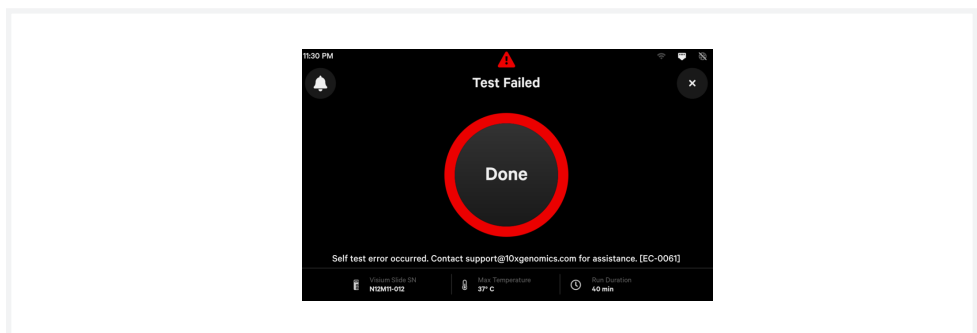

Troubleshooting

contd.

The Visium Slide Stage of the Visium CytAssist has been designed to catch and contain drips and a small volume of liquid spills. If lab safety guidelines permit, a soft lab towel may be used to clean these areas with a mixture of mild detergent and distilled water. The external instrument surfaces and slide stages can tolerate periodic additional cleaning with a 10% bleach solution followed by a 70% ethanol or 70% isopropanol wash. Follow the relevant lab safety requirements when cleaning the CytAssist instrument.

Clean glass windows with dry polyester swabs (such as Texwipe TX714A Cleanroom Swab, 0.5”L - EW-33677-62 from Cole-Parmer or equivalent). Use a bright light (e.g. flashlight) to inspect the glass windows for any smudges and remove them as described above.

If the problem persists, contact support@10xgenomics.com.

- **System error when installing software/license:** Occurs when instrument is unable to connect to the 10x Cloud or the internet to download firmware update, likely due to firewall settings. Contact an IT professional to resolve. For more information on enabling connectivity to the 10x Cloud, refer to the Visium CytAssist Network Connectivity Guidelines Technical Note (CG000653). Icons shown below are not visible during First Time Use setup.

Icon: 10x Cloud Not Connected



Icon: Internet Not Connected

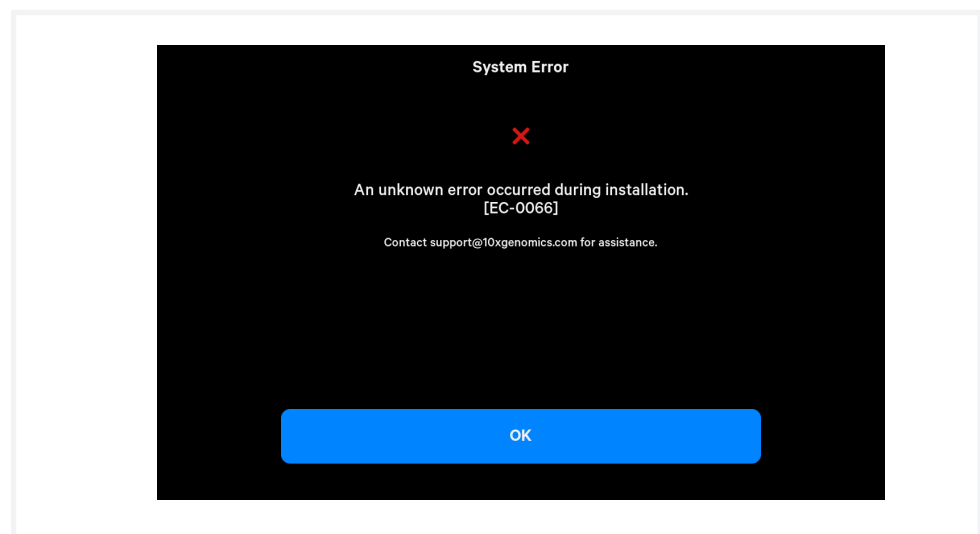

Error Screens

The touchscreen will guide the user through recoverable errors. If the error continues, or if the instrument has seen critical or intermediate errors, email support@10xgenomics.com with the instrument serial number and error code displayed.

Support will request log files for troubleshooting. Upload pertinent logs to 10x Genomics by navigating to the Logs menu option on screen. (See [Run Data](#) section).

There are two types of errors:

Critical Errors – When the instrument has seen a critical error, the run will immediately abort. Do not proceed with any further runs. Contact support@10xgenomics.com with the error code.

- System Error
- Run Error
- Canceled

User Recoverable Errors – Follow error handling instructions through the touchscreen and continue the run.

- Slide Error
- Network Error
- Update Error