

Specifications | CG000570 | Rev B

Visium CytAssist

For use with:

Visium CytAssist & Accessory Kit, 12-Month Warranty, PN-1000441

Visium CytAssist & Accessory Kit, 24-Month Warranty, PN-1000442

Visium CytAssist, Refurbished, PN-1000432R



Notices

Document Number

CG000570 | Rev B

Legal Notices

© 2024 10x Genomics, Inc. (10x Genomics). All rights reserved. Duplication and/or reproduction of all or any portion of this document without the express written consent of 10x Genomics, is strictly forbidden. Nothing contained herein shall constitute any warranty, express or implied, as to the performance of any products described herein. Any and all warranties applicable to any products are set forth in the applicable terms and conditions of sale accompanying the purchase of such product. 10x Genomics provides no warranty and hereby disclaims any and all warranties as to the use of any third-party products or protocols described herein. The use of products described herein is subject to certain restrictions as set forth in the applicable terms and conditions of sale accompanying the purchase of such product. A non-exhaustive list of 10x Genomics' marks, many of which are registered in the United States and other countries can be viewed at: www.10xgenomics.com/trademarks. 10x Genomics may refer to the products or services offered by other companies by their brand name or company name solely for clarity, and does not claim any rights in those third-party marks or names. 10x Genomics products may be covered by one or more of the patents as indicated at: www.10xgenomics.com/patents. The use of products described herein is subject to 10x Genomics Terms and Conditions of Sale, available at www.10xgenomics.com/legal-notices, or such other terms that have been agreed to in writing between 10x Genomics and user. All products and services described herein are intended FOR RESEARCH USE ONLY and NOT FOR USE IN DIAGNOSTIC PROCEDURES.

Instrument & Licensed Software Updates Warranties

Updates to existing Instruments and Licensed Software may be required to enable customers to use new or existing products. In the event of an Instrument failure resulting from an update, such failed Instrument will be replaced or repaired in accordance with the 10x Limited Warranty, Assurance Plan or service agreement, only if such Instrument is covered by any of the foregoing at the time of such failure. Instruments not covered under a current 10x Limited Warranty, Assurance Plan or service agreement will not be replaced or repaired.

Support

Email: support@10xgenomics.com

10x Genomics

6230 Stoneridge Mall Road

Pleasanton, CA 94588 USA

Document Revision Summary

Document Number

CG000570 | Rev B

Title

Visium CytAssist Specifications

Revision

Rev A to Rev B

Revision Date

September 2024

Description of Changes

- Updated title page to include new part number for refurbished instrument.
- Updated instrument images (p. 4)

Product Identification Label

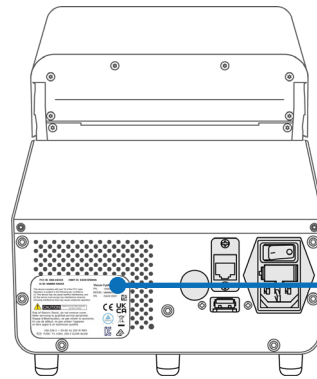

Image of label for reference only

FCC ID: XNX-XXXXX CMIIT ID: XXXYZNNNN
 IC ID: NNNXX-XXXXX

This device complies with part 15 of the FCC rules. Operation is subject to the following two conditions:
 (1) This device may not cause harmful interference, and
 (2) This device must accept any interference received, including interference that may cause undesired operation.

CAUTION RISK OF ELECTRIC SHOCK DO NOT OPEN
 Risk of Electric Shock, do not remove cover. Refer servicing to qualified service personnel. Risque d'électrocution, ne pas retirer le couvercle. En cas de défaut, ne pas utiliser l'appareil et faire appel à un technicien qualifié.

100-240 V ~ 50-60 Hz 250 W MAX
 FUSE: T3.15AH, 250 V SLOW BLOW
 10X GENOMICS, Pleasanton, CA USA

Visium CytAssist
 PN: 1000432
 MODEL: NNNNN-NN
 SN: CAVG10001

CE UK CA

 Made in Singapore

Instrument Serial Number

Product Specifications

Parameter	Specifications												
Weight	~18.3 lb (8.3 kg)												
Instrument Dimensions with: Lid closed Lid open Maximum height	<table style="width: 100%; border-collapse: collapse;"> <thead> <tr> <th style="width: 33%;">W</th> <th style="width: 33%;">D</th> <th style="width: 33%;">H</th> </tr> </thead> <tbody> <tr> <td>8" [203 mm]</td> <td>12.3" [313 mm]</td> <td>9.76" [248 mm]</td> </tr> <tr> <td>8" [203 mm]</td> <td>12.3" [313 mm]</td> <td>12.3" [312 mm]</td> </tr> <tr> <td></td> <td></td> <td>13.1" [334 mm]</td> </tr> </tbody> </table>	W	D	H	8" [203 mm]	12.3" [313 mm]	9.76" [248 mm]	8" [203 mm]	12.3" [313 mm]	12.3" [312 mm]			13.1" [334 mm]
W	D	H											
8" [203 mm]	12.3" [313 mm]	9.76" [248 mm]											
8" [203 mm]	12.3" [313 mm]	12.3" [312 mm]											
		13.1" [334 mm]											
Electrical Requirements Nominal <i>from a standard 3-prong wall receptacle that includes a safety ground pin</i>	100-240 VAC, 50/60 Hz, 250 W 80-264 V operational range (+/- 10% of nominal) Overvoltage Category II (standard receptacle)												
Pollution	Degree 2 (Indoor Use Only)												
Ventilation Requirement	Minimum 4" [10 cm] Around all sides												
Operating Temperature	64-82°F [18-28°C] Use in a typical indoor laboratory environment. Extreme temperature conditions will affect the sensitive reagents used with the instrument.												
Humidity	30-80% R.H. non-condensing												
Power Cable Length <i>Power cables will be in accordance with regional specifications</i>	6-7 ft [2 m] Standard												

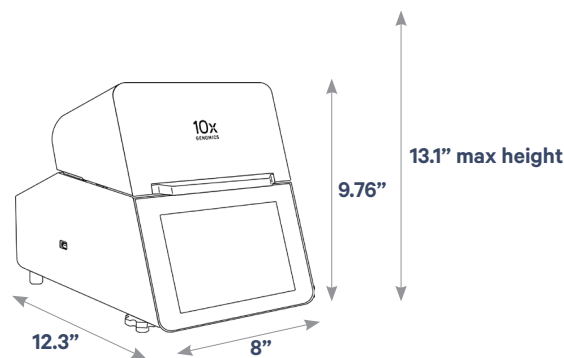





The instrument requires a ~20 min cool down between runs.

Safety

Before operation, ensure that all potential users have received:

- Instruction in general safety practices for laboratories.
- Instruction in specific safety practices for the instrument.
- All related Safety Data Sheet (SDS) documents.

Precautions are illustrated in the following way:

Symbols	Description
	The general Warning symbol indicates the possibility of damaging the instrument or compromising the results of a method.
	The Electrical Hazard symbol indicates the presence of electrical components that can be harmful to the operator if handled incorrectly.
	The Mechanical Hazard symbol indicates the presence of moving mechanical parts that can be harmful to the operator if handled incorrectly.
	The Hazardous Materials symbol indicates the presence of materials that are toxic or otherwise harmful to the operator if handled incorrectly.
	The Biohazard symbol indicates the presence of biological samples that can be harmful to the operator if handled incorrectly.



Ensure ground is reliably connected before plugging the instrument’s power cord into the power source (receptacle). *Grounding is required to prevent electric shock. If the power source is not grounded, qualified personnel must first install a reliable safety ground.*







Pinch risk: Ensure no obstructions or fingers present near closing lid.



Warning: Avoid using the Visium CytAssist in a manner not specified by 10x Genomics. The Visium CytAssist has been designed to protect the user. If used improperly, the intended user protections can be impaired.

Regulatory

The Visium CytAssist has been designed, tested, and certified to be in compliance with the following standards:

Certification	Standards
	TUV Certification only for Visium CytAssist UL 61010-1:2012 and CAN/CSA C22.2 No. 61010-1-12 with a cTUVus mark to indicate that the product has been tested and certified to Canadian and US standards by TÜV Rheinland and can be legally installed in those countries.
	IEC/EN 61010-1:2010 (3rd Edition): Safety Requirements for Electrical Equipment for Measurement, Control, and Laboratory use.
	EN 61326-1:2013: Electrical Equipment for Measurement, Control and Laboratory Use. EMC Requirements.
	The RCM mark indicates an electrical product complies with all the requirements of the electrical and EMC regulations of Australia and New Zealand in accordance with AS/NZS Standards
	CE Mark indicates that assembly is covered by a Declaration of Conformity, and has been declared in conformity with the provisions of all applicable directives in the European Union.
	UKCA Mark indicates that assembly is covered by a Declaration of Conformity, and has been declared in conformity with the provisions of all applicable directives in the United Kingdom.
	EN 61326-2-6: Specifies minimum requirements for immunity and emissions regarding electromagnetic compatibility for in vitro diagnostic medical equipment, taking into account the particularities and specific aspects of this electrical equipment and their electromagnetic environment.
	EN 61000-3-2: Electromagnetic compatibility (EMC) - Part 3-2: Limits - Limits for harmonic current emissions (equipment input current ≤16 A per phase).
	EN 61000-3-3: Electromagnetic compatibility (EMC) - Part 3-3: Limits - Limitation of voltage changes, voltage fluctuations and flicker in public low-voltage supply systems, for equipment with rated current ≤16 A per phase and not subject to conditional connection.
	RoHS Directive (2011/65/EU) and amendment (EU) 2015/863: Restriction of the use of certain hazardous substances in electrical and electronic equipment.
	WEEE Directive (2012/19/EU): Waste Electrical and Electronic Equipment.
	FCC ID: N6C-SDPAC, IC: 4908A-SDPAC FCC Part 15 Class A. NOTE: This equipment has been tested and found to comply with the limits for a Class A digital device, pursuant to part 15 of the FCC Rules. These limits are designed to provide reasonable protection against harmful interference when the equipment is operated in a commercial environment. This equipment generates, uses, and can radiate radio frequency energy and, if not installed and used in accordance with the instruction manual, may cause harmful interference to radio communications. Operation of this equipment in a residential area is likely to cause harmful interference in which case the user will be required to correct the interference at his own expense. This device complies with part 15 of the FCC Rules. Operation is subject to the following two conditions: (1) This device may not cause harmful interference, and (2) this device must accept any interference received, including interference that may cause undesired operation.
	ICES-003 (Canada): This Class A digital apparatus complies with Canadian ICES-003. Cet appareil numérique de la classe A est conforme à la norme NMB-003 du Canada.

System Maintenance

Clean Up After a Run

- a. **After a Readiness Test or Training Run:** Open lid and store the blank slides and the calibration slide away from sunlight and extreme temperature, in the original packaging bag. Retain for future use. Proceed to step c.



After a Run: IMMEDIATELY open lid after a successful run, remove Visium CytAssist Spatial Slide from the instrument, and proceed with the protocol workflow. During the next stopping point in the workflow, proceed to step b.

- b. Dispose of tissue slides appropriately.
- c. Wipe down the Tissue Slide Stage and the Visium Slide Stage with 5-10 % bleach solution followed by 70% ethanol or 70% isopropanol. Remove debris with compressed air as needed. Clean glass windows with dry polyester swabs (such as Texwipe TX714A Cleanroom Swab, 0.5”L - EW-33677-62 from Cole-Parmer or equivalent) and compressed air. Use a bright light (e.g. flashlight) to inspect the glass windows for any smudges and remove them as described above.

Wipe the stages down with 5-10 % bleach followed by 70% ethanol



- d. Close the lid (clicking sound indicates closure). Wipe down the base and lid of the instrument.

Interior

The Visium Slide Stage of the Visium CytAssist has been designed to catch and contain drips and a small volume of liquid spills. Occasionally, use a soft lab towel to clean these areas with a mixture of mild detergent and distilled water. For deeper, more thorough cleaning, it is acceptable to use a 5-10% Bleach solution followed by a 70% ethanol or 70% isopropanol wash. Dry using compressed air.



Do not use acetone or other harsh solvents. Apply all standard safety practices when using cleaners, and dispose of any generated waste in a responsible manner.

System Maintenance

contd.

Exterior

The exterior of the Visium CytAssist should always be kept clean and free of dust and debris that may affect its function and/or cooling efficiency. Generally, the exterior finish can be wiped down using a mixture of mild detergent and distilled water applied to a slightly dampened lab towel. As an added precaution it is recommended that the instrument be unplugged from the power source before beginning any thorough cleaning process.

Service



Electrical shock hazard. Do not open the Visium CytAssist in a manner not specified during standard operation. There are no user-serviceable parts inside. Refer all servicing to qualified 10x Genomics service personnel.

Servicing is required when the Visium CytAssist has been damaged in any way (e.g., a power entry module or plug is damaged, liquid was spilled into, or objects fell into the instrument, the instrument does not operate properly, or has been dropped).

Use only the power cord supplied with the Visium CytAssist. Do not replace it with a non-approved power cord as it may be inadequately rated to handle the electrical loads.

If replacing the externally accessible fuses in the power entry module becomes necessary, use only certified (EN60127 Sheet 5) 5 x 20 mm sized fuses rated T3.15AH, 250V Slow-Blow or equivalent.

When returning a Visium CytAssist for repair, take steps to ensure that the instrument has been decontaminated so as not to pose a hazard for 10x Genomics service personnel.

Environmental Requirements

It is the design intent of the Visium CytAssist that it be used in a typical indoor laboratory environment. The instrument's operating temperature is 18–28°C (64–82°F), humidity 80% Max (Non-Condensing) (see [Product Specifications](#)).