



[User Guide](#) | [CG000582](#) | [Rev G](#)

# Xenium

## In Situ Gene Expression

Probe Hybridization, Ligation & Amplification

**For use with:**

Xenium Slides & Sample Prep Reagents (2 slides, 2 rxns) PN-1000460

Xenium Decoding Consumables (1 run, 2 slides) PN-1000487

Xenium Pre-Designed Gene Expression Panel - (2 rxns)\*

Xenium Add-on Custom Gene Panel - (4 & 16 rxns)\*

Xenium Standalone Custom Gene Panel - (4 & 16 rxns)\*

Xenium Instrument Accessory Kit Module A PN-1000530

Xenium Slide, Kit, 4 Slides PN-1000659

Xenium Slide Kit, 16 Slides PN-1000660

\*Refer to the 10x Genomics Support Website for the most current list of available panels and part numbers.

# Notices

## Document Number

CG000582 | Rev G

## Legal Notices

© 2024 10x Genomics, Inc. (10x Genomics). All rights reserved. Duplication and/or reproduction of all or any portion of this document without the express written consent of 10x Genomics, is strictly forbidden. Nothing contained herein shall constitute any warranty, express or implied, as to the performance of any products described herein. Any and all warranties applicable to any products are set forth in the applicable terms and conditions of sale accompanying the purchase of such product. 10x Genomics provides no warranty and hereby disclaims any and all warranties as to the use of any third-party products or protocols described herein. The use of products described herein is subject to certain restrictions as set forth in the applicable terms and conditions of sale accompanying the purchase of such product. A non-exhaustive list of 10x Genomics' marks, many of which are registered in the United States and other countries can be viewed at: [www.10xgenomics.com/trademarks](http://www.10xgenomics.com/trademarks). 10x Genomics may refer to the products or services offered by other companies by their brand name or company name solely for clarity, and does not claim any rights in those third-party marks or names. 10x Genomics products may be covered by one or more of the patents as indicated at: [www.10xgenomics.com/patents](http://www.10xgenomics.com/patents). The use of products described herein is subject to 10x Genomics Terms and Conditions of Sale, available at [www.10xgenomics.com/legal-notices](http://www.10xgenomics.com/legal-notices), or such other terms that have been agreed to in writing between 10x Genomics and user. All products and services described herein are intended FOR RESEARCH USE ONLY and NOT FOR USE IN DIAGNOSTIC PROCEDURES.

## Instrument & Licensed Software Updates Warranties

Updates to existing Instruments and Licensed Software may be required to enable customers to use new or existing products.

## Support

Email: [support@10xgenomics.com](mailto:support@10xgenomics.com)

10x Genomics

6230 Stoneridge Mall Road

Pleasanton, CA

# Document Revision Summary

**Document Number**

CG000582

**Title**

Xenium In Situ Gene Expression Probe Hybridization, Ligation & Amplification User Guide

**Revision**

Rev G

**Revision Date**

September 13, 2024

**Description of Changes**

- Added storage temperature to Reagent Kits (pages 7-11).
- Updated Tips & Best Practices for Xenium Cassette wash and storage conditions (pages 29 and 30).
- Updated custom probe preparation & handling instructions on page 36.
- Added guidance about cracked or broken slides on page 45.
- Updated Custom Probe Preparation guidance on page 39.
- Updated ethanol wash instructions during Autofluorescence Quenching on page 60.
- Added guidance about keeping slides assay-specific on page 61.
- Updated PBS-T wash step formatting throughout.
- Updated for general minor consistency of language, format, and terms throughout.

# Table of Contents

<b>Introduction</b>	
Reagent Kits	7
Recommended Thermal Cyclers	12
Additional Kits, Reagents & Equipment	13
Protocol Steps & Timing	15
Stepwise Objectives	16
<b>Tips &amp; Best Practices</b>	
Icons	22
General Reagent Handling	22
Pipette Calibration	22
Probe Panel Handling	22
Probe Panel Storage & Shipping	24
Xenium Slide Handling	25
Processing a Single Xenium Slide	26
Reagent Addition to Wells	27
Reagent Removal from Wells	27
Xenium Cassette Lid Application & Removal	28
Xenium Cassette Storage	29
Slide Incubation Guidance	31
Tissue Detachment on Xenium Slides	34
<b>Step 1: Probe Hybridization</b>	
1.0 Get Started	36
1.1 Buffer Preparation	38
1.2 Custom Probe Preparation (optional)	39
1.3 Probe Hybridization	40
<b>Step 2: Post Hybridization Wash</b>	
2.0 Get Started	44
2.1 Post Hybridization Wash	45
<b>Step 3: Ligation</b>	
3.0 Get Started	48
3.1 Ligation	49

# Table of Contents

<b>Step 4: Amplification</b>	
4.0 Get Started	52
4.1 Amplification	53
4.2 Post Amplification Wash	55
<b>Step 5: Autofluorescence Quenching</b>	
5.0 Get Started	57
5.1 Autofluorescence Quenching	58
5.2 Nuclei Staining	61
<b>Troubleshooting</b>	
<b>Appendix</b>	
Probe Panel Selection	74
Sample Shipping	74



# Introduction













Reagent Kits	7
Recommended Thermal Cyclers	12
Additional Kits, Reagents & Equipment	13
Protocol Steps & Timing	15
Stepwise Objectives	16

## Reagent Kits

Xenium In Situ Gene Expression Reagent Kits



*Refer to SDS for handling and disposal information.*

### Xenium Slides & Sample Prep Reagents - (2 Slides, 2 rxns) PN-1000460

<b>Xenium Slides &amp; Sample Prep Reagents</b>			
(2 slides, 2 rxns), PN-1000460			
Shipped in dry ice			
Store at -20°C			
		#	PN
	Xenium Probe Hybridization Buffer	1	2000390
	Xenium Post Hybridization Wash Buffer	1	2000395
	Xenium Ligation Buffer	1	2000391
	Xenium Ligation Enzyme A	1	2000397
	Xenium Ligation Enzyme B	1	2000398
	Xenium Amplification Mix	1	2000392
	Xenium Amplification Enzyme	1	2000399
	Reducing Agent B	1	2000087
	Xenium Autofluorescence Mix	1	2000753
	Xenium FFPE Tissue Enhancer*	1	2000798
	Xenium Nuclei Staining Buffer	1	2000762
	Perm Enzyme B	1	3000553
	Xenium Slides (2 pack)	1	3000941

All items, except Xenium FFPE Tissue Enhancer (PN-2000798) and Perm Enzyme B (PN-3000553), are needed for this workflow.



## Xenium Decoding Consumables - (1 Run, 2 Slides) PN-1000487

<b>Xenium Decoding Consumables</b> (1 run, 2 slides), PN-1000487 <i>Shipped at ambient temp</i> <i>Store at ambient temp</i>		
	#	PN
Xenium Cassette Kit (2 cassettes + 16 lids)	1	1000566
Extraction Tip	1	2000757
Pipette Tips	1	3000866
Xenium Buffer Cap	4	3000949
Xenium Objective Wetting Consumable	1	2000749
 Deionized Water (bottle)	1	3001198
 Xenium Sample Wash Buffer A (bottle)	1	3001199
 Xenium Sample Wash Buffer B (bottle)	1	3001200
 Xenium Probe Removal Buffer (bottle)	1	3001201



Only the Xenium Cassette Kit (2 cassettes + 16 lids) is needed for this workflow.

## Xenium Pre-Designed Gene Expression Panel - (2 rxns)

<b>Xenium Pre-Designed Gene Expression Panel</b> (2 rxns) <i>Shipped in dry ice</i> <i>Store at -20°C</i>		
	#	PN
 Xenium Probe Dilution Buffer ( <i>to be discontinued</i> )	1	2000393
 Xenium Pre-Designed Gene Expression Probes*	1	-



Example Xenium Pre-Designed Gene Expression Panel kit. Pre-designed panel kits contain one or two tubes - Xenium Probes with or without Xenium Probe Dilution Buffer.



\*Refer to the 10x Genomics Support Website for the most updated list of available panels and part numbers.



Use TE Buffer instead of Xenium Probe Dilution Buffer (to be discontinued) without any impact on assay performance. Relevant guidance is provided in the workflow steps.

### Xenium Add-on Custom Gene Panel - (4 & 16 rxns)

<b>Xenium Add-on Custom Gene Panel</b>		
(4 & 16 rxns)		
<i>Shipped/stored at ambient temp</i>		
<i>Store at -20°C after resuspension</i>		
	#	PN
Xenium Probe		
● Dilution Buffer (to be discontinued)	1	2000393
○ Xenium Add-on Custom Probes*	1	-

Example Xenium Add-on Custom Gene Panel kit. Add-on custom panel kits contain one or two tubes - Xenium Probes with or without Xenium Probe Dilution Buffer.

\*Refer to the 10x Genomics Support Website for the most updated list of available panels and part numbers.



Use TE Buffer instead of Xenium Probe Dilution Buffer (to be discontinued) without any impact on assay performance. Relevant guidance is provided in the workflow steps.

### Xenium Standalone Custom Gene Panel - (4 & 16 rxns)

<b>Xenium Standalone Custom Gene Panel</b>		
(4 & 16 rxns)		
<i>Shipped/stored at ambient temp</i>		
<i>Store at -20°C after resuspension</i>		
	#	PN
Xenium Probe		
● Dilution Buffer (to be discontinued)	1	2000393
○ Xenium Standalone Custom Probes*	1	-

Example Xenium Standalone Custom Gene Panel kit. Standalone custom panel kits contain one or two tubes - Xenium Probes with or without Xenium Probe Dilution Buffer.

\*Refer to the 10x Genomics Support Website for the most updated list of available panels and part numbers.



Use TE Buffer instead of Xenium Probe Dilution Buffer (to be discontinued) without any impact on assay performance. Relevant guidance is provided in the workflow steps.

## Xenium Instrument Accessory Kit, Module A PN-1000530

<b>Xenium Instrument Accessory Kit Module A</b> PN-1000530 <i>Shipped at ambient temp</i> <i>Store at ambient temp</i>		
	#	PN
Waste Bottle	1	3000955
Xenium Waste Tip Tray	1	3000957
Xenium Thermocycler Adaptor	1	3000954
<b>10x</b> GENOMICS		

Only the Xenium Thermocycler Adaptor (PN-3000954) is needed for this workflow.

## Xenium Slide Kit, 4 Slides PN-1000659

<b>Xenium Slide Kit, 4 slides</b> PN-1000659 <i>Shipped in dry ice</i> <i>Store at -20°C</i>		
	#	PN
Xenium Slides (2 pack)	2	3000941
<b>10x</b> GENOMICS		

## Xenium Slide Kit, 16 Slides PN-1000660

<b>Xenium Slide Kit, 16 slides</b> PN-1000660 <i>Shipped in dry ice</i> <i>Store at -20°C</i>		
	#	PN
Xenium Slides (2 pack)	8	3000941
<b>10x</b> GENOMICS		

## Recommended Thermal Cyclers

Supplier	Description	Part Number
Bio-Rad	C1000 Touch Thermal Cycler with 96-Deep Well Reaction Module (discontinued)	1851197
Analytik Jena	Biometra TAdvanced 96 SG with 96-well block (silver, 0.2 mL) and gradient function	846-x-070-241 (where x=2 for 230 V; 4 for 115 V; 5 for 100 V, 50-60 Hz)
VWR	Gradient thermal cycler, XT <sup>96</sup> Gradient, with 96-well gradient block and standard lid	76452-153
Marshall Scientific	MJ Research PTC-200 Thermal Cycler (discontinued)	05434-05

## Additional Kits, Reagents & Equipment



10x Genomics has tested all items listed below. These items perform optimally with the assay. **Substituting materials may adversely affect system performance.** For items with multiple options listed, choose option based on availability and preference. Refer to the manufacturer's website for regional part numbers.

Item	Description	Supplier	Part Number (US)
<b>Plastics</b>			
1.5 ml tubes	DNA LoBind Tubes, 1.5 ml	Eppendorf	022431021
	Low DNA Binding Tubes, 1.5 ml	Sarstedt	72.706.700
15 ml tubes	15 ml PP Centrifuge Tubes (or equivalent)	Corning	430791
50 ml tubes	Self-Standing Polypropylene Centrifuge Tubes (50 ml), sterile (or equivalent)	Corning	430921
Pipette tips	Tips LTS 20UL Filter RT-L20FLR (or equivalent)	Rainin	30389226
	Tips LTS 200UL Filter RT-L200FLR (or equivalent)	Rainin	30389240
	Tips LTS 1ML Filter RT-L1000FLR (or equivalent)	Rainin	30389213
<b>Kits &amp; Reagents</b>			
Nuclease-free Water	Nuclease-free Water (not DEPC treated)	Thermo Fisher Scientific	AM9937
TE Buffer	TE Buffer, TRIS-EDTA, 1X Solution, pH 8.0 (nuclease-free)	Fisher Scientific	BP24731
PBS	PBS - Phosphate Buffered Saline (10X) pH 7.4, RNase-free	Thermo Fisher Scientific	AM9624
10% Tween-20	Tween 20 Surfact-Amps Detergent Solution (10% solution) (not 100% Tween diluted to 10%)	Thermo Fisher Scientific	28320
	10% Tween 20	Bio-Rad	1662404
Ethanol	Ethyl alcohol, Pure (200 Proof, anhydrous)	Millipore Sigma	E7023-500ML
Glycerol	Glycerol, 99.5%, for molecular biology, DNase, RNase and Protease free (optional, if storing slides long-term)	Acros Organics	327255000
<b>Equipment</b>			
Pipettes	Pipet-Lite LTS Pipette L-20XLS+	Rainin	17014392
	Pipet-Lite LTS Pipette L-200XLS+	Rainin	17014391
	Pipet-Lite LTS Pipette L-1000XLS+	Rainin	17014382
Mini centrifuge	VWR Mini Centrifuge (or any equivalent mini centrifuge)	VWR	76269-064
Thermomixer	Eppendorf ThermoMixer C (or any equivalent Thermomixer)	Eppendorf	5382000023

Item	Description	Supplier	Part Number (US)
Thermoblock	Eppendorf SmartBlock 2.0 mL (or any equivalent Thermoblock)	Eppendorf	5362000035
<b>Additional Materials</b>			
Waterbath (bead bath untested)			
Thermal Cycler (see Recommended Thermal Cyclers)			
Ice bucket			
Vortex			
Lens-cleaning Paper or Lint-free Laboratory Wipes (for wiping thermal cycler adaptor)			
PCR Sealing Film (optional, if storing long-term)			
Ultrapure/Milli-Q Water for Water Bath (recommended), from Milli-Q Integral Ultrapure Water System or equivalent			

*This list may not include some standard laboratory equipment.*

## Protocol Steps & Timing

Steps	Timing	Stop & Store
<b>Day 1</b>		
<b>Step 1: Probe Hybridization</b>		
1.1 Buffer Preparation	20 min	
1.2 Custom Probe Preparation (optional)	10 min	
1.3 Probe Hybridization	16-24 h (overnight)	
<b>Day 2</b>		
<b>Step 2: Post Hybridization Wash</b>		
2.1 Post Hybridization Wash	35 min	
<b>Step 3: Ligation</b>		
3.1 Ligation	~2 h	
<b>Step 4: Amplification</b>		
4.1 Amplification	~2 h	
4.2 Post Amplification Wash	15 min	
<b>Step 5: Autofluorescence Quenching</b>		
5.1 Autofluorescence Quenching	45 min	 4°C overnight (in the dark)
5.2 Nuclei Staining	10 min	 4°C overnight or 1 week (in the dark)*

\*After Nuclei Staining, the slides can also be stored long term in a cryoprotectant at -20°C as described in [Xenium Cassette Storage on page 29](#).



*Storing slides for more than one month risks ~5% decrease in sensitivity. These risks are dependent on many factors, including input tissue quality and how nuclease-free and microbe-free the workflow is.*

## Stepwise Objectives

Xenium In Situ Gene Expression assays RNA at the subcellular level by using targeted probes in formalin fixed & paraffin embedded (FFPE) or fresh frozen (FF) tissue sections. FFPE tissue sections placed on Xenium Slides are deparaffinized and decrosslinked as described in Xenium In Situ for FFPE - Deparaffinization & Decrosslinking (Demonstrated Protocol – CG000580). FF tissue sections placed on Xenium slides are fixed and permeabilized as described in Xenium In Situ for Fresh Frozen - Fixation & Permeabilization (Demonstrated Protocol – CG000581).

Pre-designed, add-on custom, or standalone custom probe panels are then added to the tissue. Each circularizable DNA probe contains two regions that hybridize to the target RNA and a third region that encodes a gene-specific barcode. The two ends of the probes bind the target RNA and are ligated to generate a circular DNA probe. Following ligation, the circularized probe is enzymatically amplified, generating multiple copies of the gene-specific barcode for each RNA target.

Xenium slides containing FFPE or FF tissue sections are then loaded for imaging and analysis on the Xenium Analyzer instrument for high-throughput, automated in situ analysis. Fluorescently labeled oligos bind to the amplified DNA probes. Cyclical rounds of fluorescent probe hybridization, imaging, and removal generate optical signatures specific for each barcode, which are converted into a gene identity. Identified transcripts can be visualized using Xenium Explorer software.

This document outlines the protocol for generating Xenium In Situ Gene Expression data from FFPE and FF tissue sections placed on Sample Areas of a Xenium slide.



## Xenium Slide

The Xenium slide has one Sample Area measuring 10.45 x 22.45 mm and is defined by a fiducial frame. The imageable area, measuring 12 mm x 24 mm, includes the area within the Sample Area + fiducial frame. FFPE or FF tissue sections are placed within the Sample Area for downstream processing and analysis.

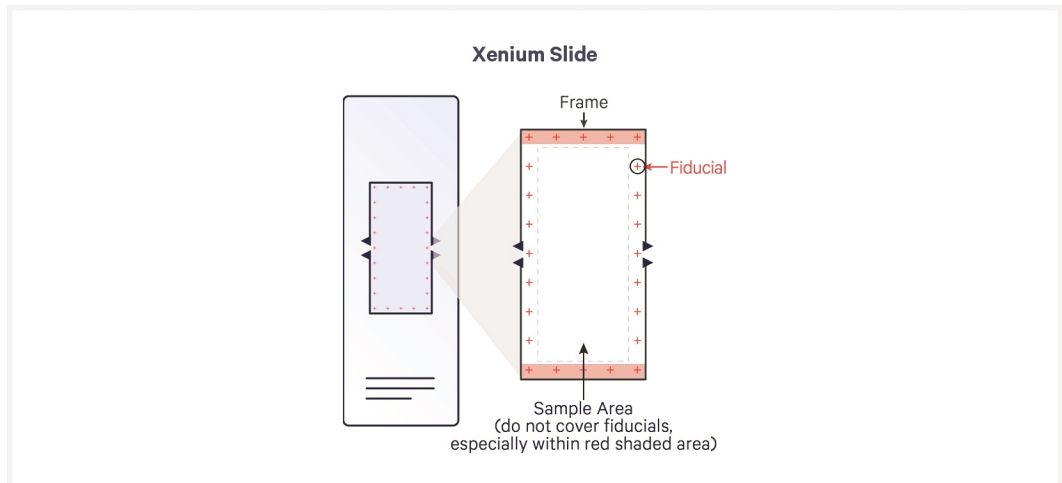

## Step 1: Probe Hybridization

Pre-designed, add-on custom, or standalone custom probe panels are added to the FFPE or FF tissue sections. The DNA probes are flanked by two regions that independently hybridize to the target RNA and also contain a gene-specific barcode sequence. The probes hybridize to their complementary target RNA in an overnight incubation.

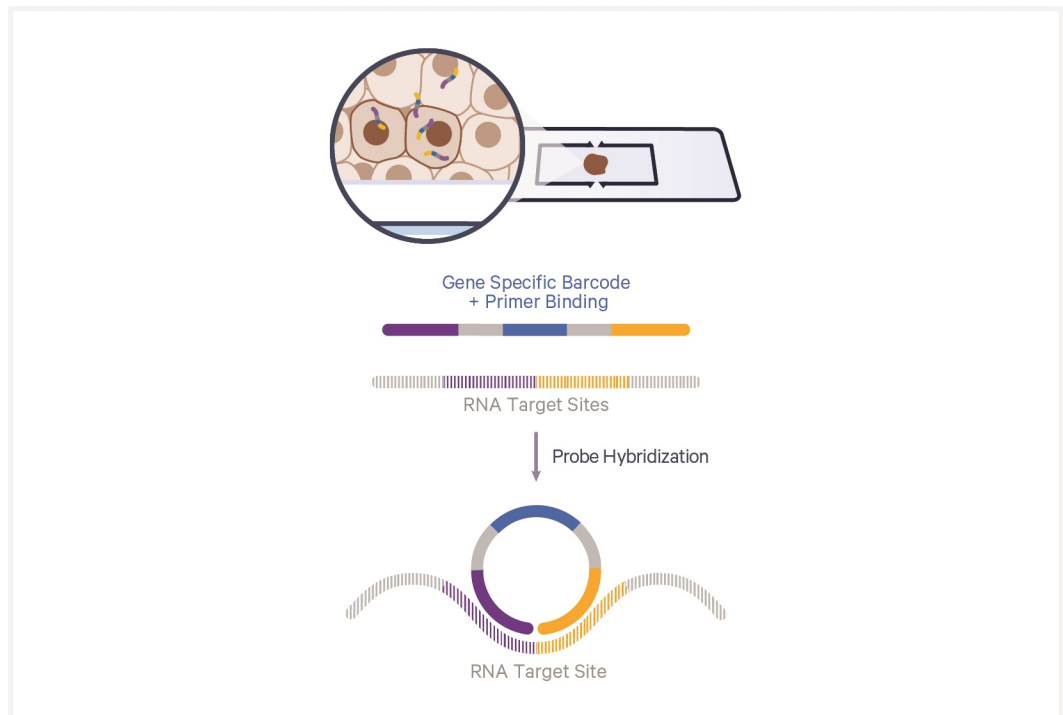

## Step 2: Post Hybridization Wash

Excess, unbound probes are washed away in the post hybridization wash step.

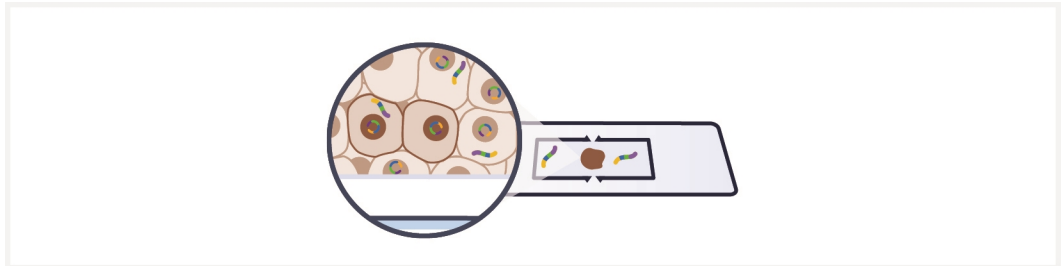

## Step 3: Ligation

After removal of unbound probes, a ligase is added to seal the junction between the probe regions that have hybridized to RNA. Ligation of the probe ends on the targeted RNA region generates a circular DNA probe. This ligation ensures a unique level of probe specificity to the target region.

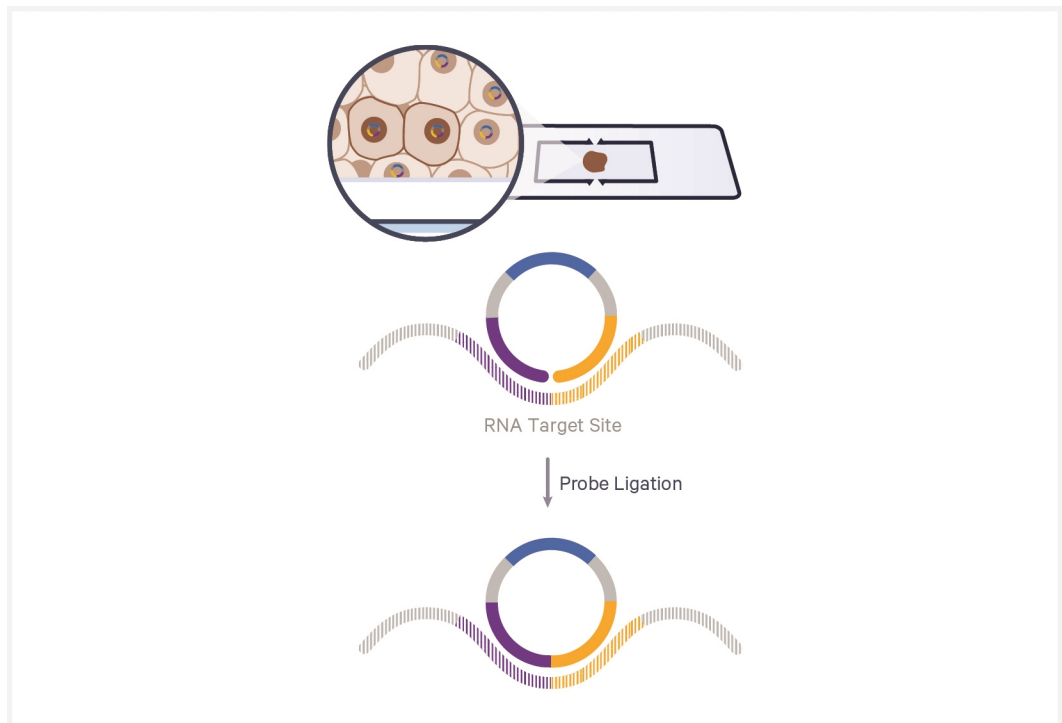

## Step 4: Amplification

The ligation products are enzymatically amplified. Hundreds of copies of the gene-specific barcode are generated during the amplification process.



## Step 5: Autofluorescence Quenching

Autofluorescence Quenching diminishes unwanted autofluorescence and enhances signal-to-noise ratio in the treated FFPE and FF tissue sections. Next, nuclei are stained with DAPI (derived from Xenium Nuclei Staining Buffer) to assist in identification of tissue or regions of interest during an instrument overview scan. Finally, tissue sections on Xenium slides assembled into Xenium Cassettes are loaded into the Xenium Analyzer for imaging and decoding.

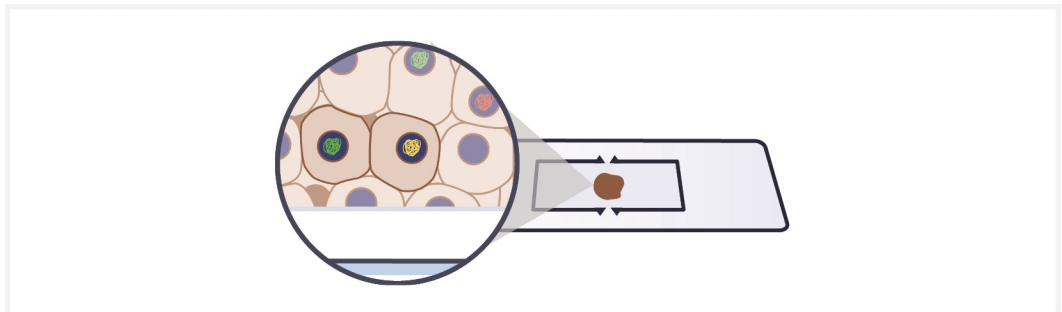

# Tips & Best Practices



Icons	22
General Reagent Handling	22
Pipette Calibration	22
Probe Panel Handling	22
Probe Panel Storage & Shipping	24
Xenium Slide Handling	25
Processing a Single Xenium Slide	26
Reagent Addition to Wells	27
Reagent Removal from Wells	27
Xenium Cassette Lid Application & Removal	28
Xenium Cassette Storage	29
Slide Incubation Guidance	31
Tissue Detachment on Xenium Slides	34

## Icons



Tips & Best Practices section includes additional guidance



Signifies critical step requiring accurate execution



Troubleshooting section includes additional guidance

## General Reagent Handling

- Fully thaw reagents at indicated temperatures. Thoroughly mix reagents before use.
- When pipette mixing reagents, unless otherwise specified, set pipette to 75% of total volume.
- Keep all enzymes and Master Mixes on ice during setup and use, unless otherwise stated.
- Promptly move reagents back to the recommended storage.

## Pipette Calibration

- Follow manufacturer's calibration and maintenance schedules.

## Probe Panel Handling

- 10x Genomics provides the following types of probe panels: pre-designed add-on custom, and standalone custom. Add-on custom panels are used to supplement pre-designed panels. Standalone custom probe panels are used alone and do not require pre-designed panels.
- Pre-designed probes are good for two Xenium slides. Add-on and Standalone custom probes are good for either four or sixteen Xenium slides.
- Add-on and Standalone custom probes are delivered lyophilized at room temperature and should be stored at -20°C upon resuspension.
- Custom probes must be resuspended prior to use. See [Custom Probe Preparation \(optional\) on page 39](#) for more details.
- Record the Custom Panel Design ID and Slide Number before starting the

workflow. This information is critical for identifying the correct electronic decode file when setting up the Xenium Analyzer in downstream steps.

## Probe Panel Storage & Shipping

- Pre-designed probe panels are ready to use and are shipped on dry ice. Pre-designed probes should be stored at -20°C upon receipt. The expiration date is listed on the kit label.
- Pre-designed probes are stable short-term at room temperature (<8 hours). Pre-designed probes should be discarded if left at room temperature for more than 8 hours.
- Add-on and Standalone custom probe panels are lyophilized and are shipped at room temperature. Store at -20°C upon receipt.
- Add-on and Standalone custom probes expire three years from the manufacture date in lyophilized form when stored at -20°C. Alternatively, custom probes expire one year from time of resuspension if stored in TE Buffer at -20°C or at kit expiration date (whichever comes first).
- Custom probes must be resuspended prior to use in TE Buffer, pH 8.0. After resuspension, they are stable for short-term at room temperature (<8 hours). Resuspended custom probes should be discarded if left at room temperature for more than 8 hours.
- Custom probes (in lyophilized form) accidentally left at room temperature for an extended period of time are likely stable. Contact [support@10xgenomics.com](mailto:support@10xgenomics.com) if further assistance is needed.



## Xenium Slide Handling

- Always wear gloves when handling slides.
- The bottom of the slide is indicated by the etched label, which should be readable when in the proper position.
- The tissue sections should always be placed within the Sample Area on etched label side of the slide.
- Hold the slide on the label. DO NOT touch the tissue sections or near fiducials.
- Minimize exposure of the slides to sources of particles and fibers.
- Keep the slide cassette flat on the bench when adding reagents to the Sample Area.
- Ensure that no absorbent surface is in contact with the reagents on the slide during incubation.
- When pipetting reagent onto a slide, avoid generating bubbles. Avoid pipetting directly onto the tissue.
- After aspirating reagent from a slide, pipette new reagent onto same slide before moving onto aspiration of second slide.

*The Xenium Slide (PN-3000941) may not always include the suffix v1 in the etched label.*

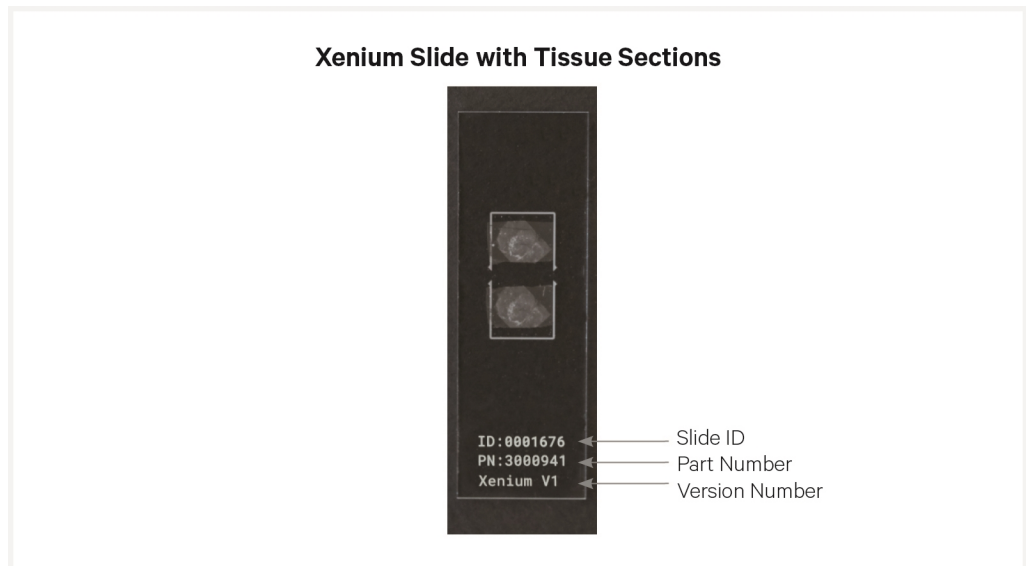

## Processing a Single Xenium Slide

- Xenium reagent kits are sufficient for two reactions, and for optimal Xenium Analyzer throughput, two slides should be run at the same time.
- It is possible to perform the Xenium In Situ Gene Expression workflow with a single slide. To do this, ensure the following best practices are followed for optimal assay performance:
  - Assemble a mock Xenium Cassette using a blank slide and a cassette from the Xenium Cassette Kit (2 cassettes), PN-1000566.
  - Insert the blank slide into the Xenium Cassette. Cassettes should be assembled following the instructions in [Troubleshooting for Cassette Assembly Failure on page 67](#).
  - Attach a Xenium Cassette Lid from the Xenium Cassette Kit (2 cassettes), PN-1000566 to the cassette containing the blank slide.



*When handling an assembled cassette with the lid applied, always hold from the bottom of the cassette and not the lid.*

- For all incubation steps with the thermal cycler lid closed, ensure the mock slide cassette is placed alongside the Xenium slide cassette containing tissue on the Thermocycler Adaptor.

## Reagent Addition to Wells

- Place assembled cassette flat on a clean work surface.
- Dispense and remove reagents along the side of the well without touching the tissue sections and without introducing bubbles.
- Always cover the Sample Area completely when adding reagents to the well. A gentle tap may help spread the reagent more evenly.

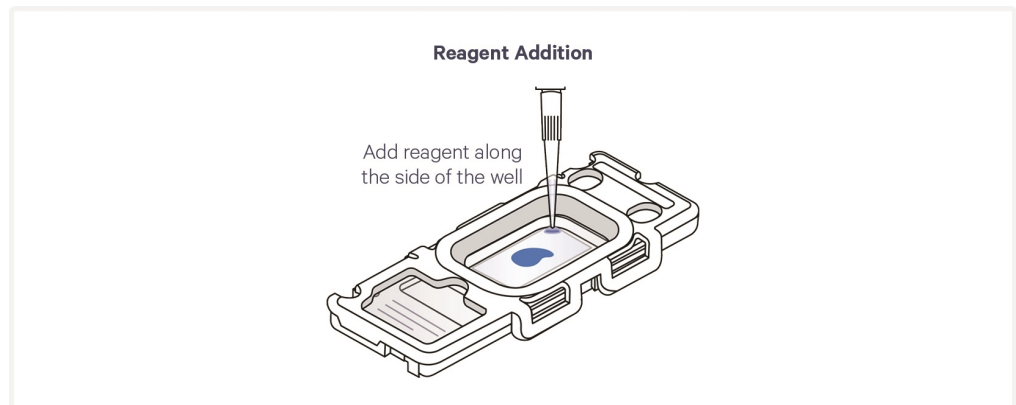

## Reagent Removal from Wells

- Place assembled cassette flat on a clean work surface.
- Slightly tilt the cassette while removing the reagent.
- Place the pipette tip on the bottom edge of the well.
- Remove reagents along the side of the well without touching the tissue sections.
- Remove all liquid from the well in each step.

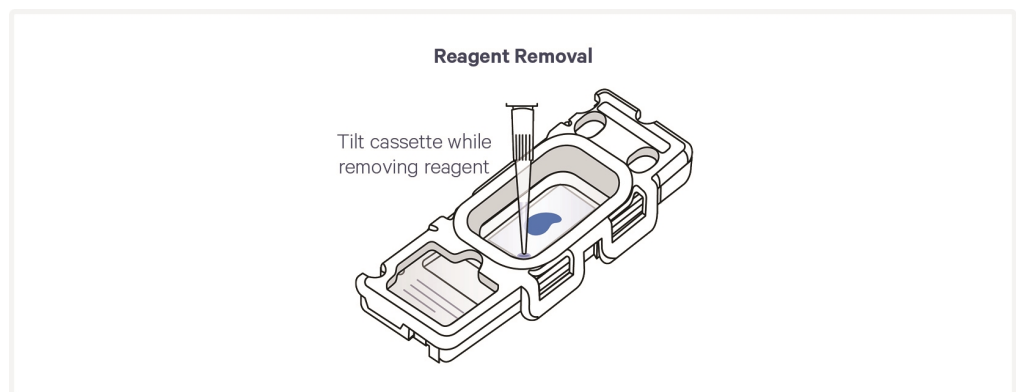

## Xenium Cassette Lid Application & Removal

- Work on a clean surface.

### Application

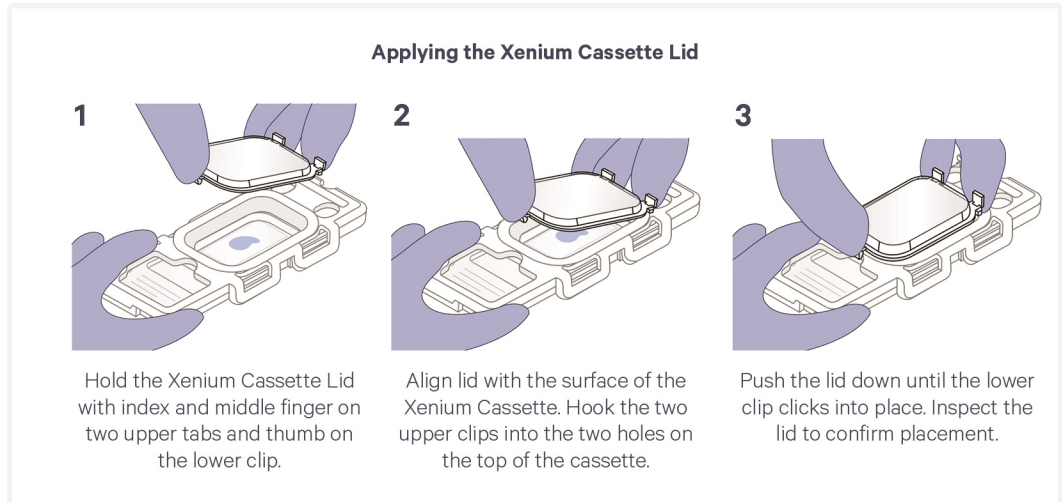

### Removal

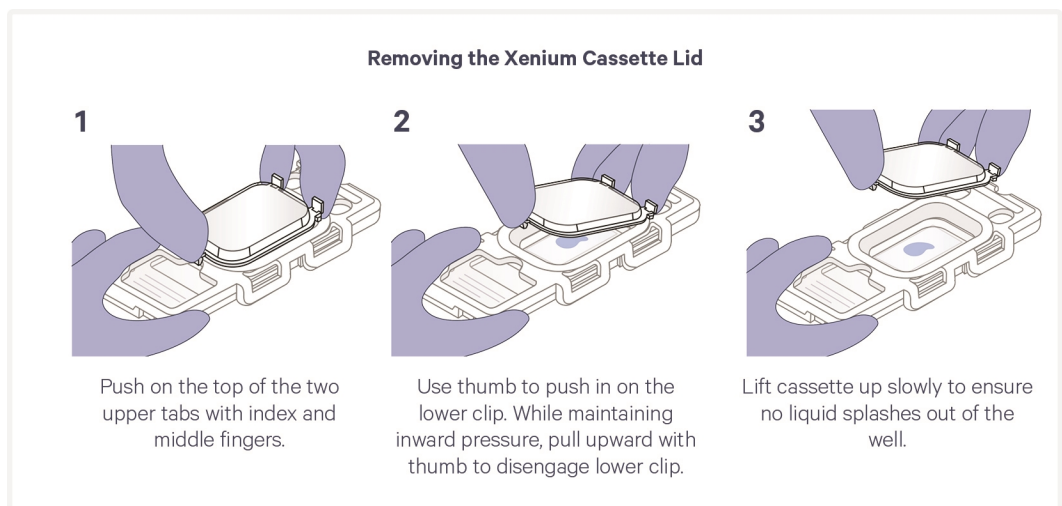

*Xenium Cassette Lids are a single use item and should be discarded after each use unless otherwise indicated. PBS-T washes DO NOT require sealing of the cassette with a lid.*

## Xenium Cassette Storage

- Store an assembled Xenium cassette with slide by applying a Xenium Cassette Lid or slide seal at the indicated stopping points listed throughout the protocol and as outlined in the [Protocol Steps & Timing on page 15](#).
- Cassettes should always be stored hydrated with recommended reagent and stored at the recommended temperature.



- **Short-term Storage ( $\leq$  1 week):**

  - Store in **1,000  $\mu$ l** PBS-T at **4°C** in the dark. Ensure that the slide is stored in microbe-free and nuclease-free conditions, with a Xenium Cassette Lid or slide seal applied to prevent evaporation.

- **Long-term Storage (1 week – 2 months):**
  - Remove all PBS-T from the cassette well.
  - Add **1,000  $\mu$ l 70%** ethanol, incubate for **2 min** at **room temperature**, remove the ethanol.
  - Add **1,000  $\mu$ l 100%** ethanol, incubate for **2 min** at **room temperature**, remove the ethanol.
  - Add **1,000  $\mu$ l 100%** ethanol, incubate for **2 min** at **room temperature**, remove the ethanol.
  - Remove slide from the cassette and place in a slide mailer containing **10 ml** or more cryoprotectant (30% Glycerol prepared in PBS) to fully submerge the slide. Clean the cassette as described in [Xenium Cassette and Lid Cleaning on page 70](#). Save for a subsequent instrument run.
  - Store at **-20°C** for up to **2 month**.

When ready to use:

- Equilibrate the mailer with the slide to room temperature (takes ~30 min)
  - Once completely thawed, rinse the mailer 3X with **10 ml** PBS-T
  - Remove the slide from the mailer, assemble in the cassette (as described on [page 67](#))
  - Add **1,000 µl** PBS-T to the cassette well.
- The above storage guidelines can also be used for storing Xenium cassettes with slides after a Xenium Analyzer run (or in the event of a run failure). Contact [support@10xgenomics.com](mailto:support@10xgenomics.com) for more information.

## Slide Incubation Guidance

### Incubation at a specified temperature

- Position a Xenium Thermocycler Adaptor on a thermal cycler that is set at the incubation temperature. Ensure thermal cycler has reached appropriate temperature prior to starting incubation.



- Ensure that the Thermocycler Adaptor is fully inserted into the thermal cycler and is in contact with the thermal cycler block surface uniformly.
- When incubating a slide, position the slide on the Thermocycler Adaptor with the tissue side facing up.



- Ensure the Sample Area is aligned with the corresponding area on the Thermocycler Adaptor. **DO NOT** close the lid.
- When incubating a slide encased in a cassette, place the assembled unit on the Thermocycler Adaptor with the well facing up. Ensure the cassette is in

complete contact with the Thermocycler Adaptor. The cassette should always be sealed with a Xenium Cassette Lid when on the Thermocycler Adaptor unless indicated otherwise.

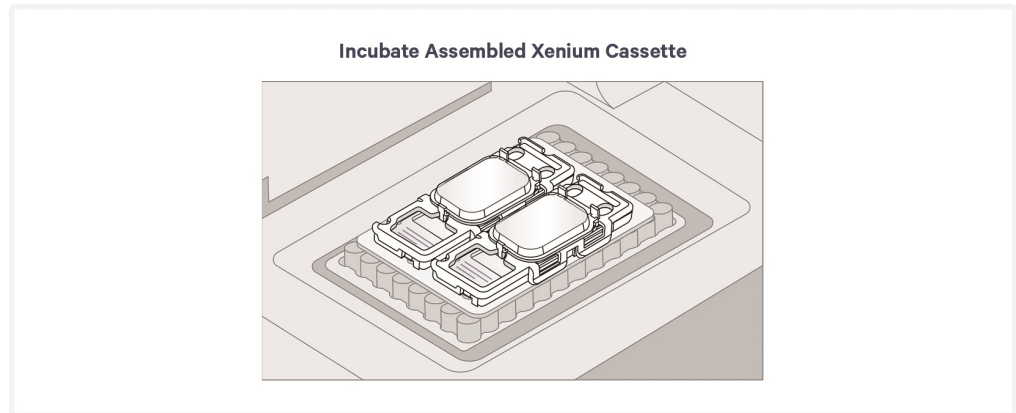

- For steps not using a Xenium Cassette Insert, where indicated, after thermal cycler incubation, at least **400 µl** should be aspirated from cassette well. If less than **400 µl** is recovered, contact [support@10xgenomics.com](mailto:support@10xgenomics.com).
- Before each incubation step, always inspect the adaptor and wipe it using a lint-free laboratory wipe. If debris or liquid is noticed, wipe the adaptor using 70% isopropanol, followed by wiping with a lint-free laboratory wipe. Failing to do so could result in slide cracking.

## Tightening the thermal cycler lid

- Thermal cycler lid contact with the Xenium Cassette Lid is critical for assay performance.
- For thermal cyclers with adjustable lids, tighten the lid until an audible click is heard. Tightening past the click risks breaking the slide.



## Incubation at room temperature

- Place the assembled cassette on a flat, clean, non-absorbent work surface.
- Ensure that no absorbent surface is in contact with the reagents on the slide/cassette during incubation.



## Tissue Detachment on Xenium Slides



- Monitor section adhesion on Xenium slides throughout the workflow.
- Tissue detachment during the workflow can negatively impact performance. If observed, contact [support@10xgenomics.com](mailto:support@10xgenomics.com).
- For more information, refer to Troubleshooting.



# Step 1:

## Probe Hybridization

1.0 Get Started	36
1.1 Buffer Preparation	38
1.2 Custom Probe Preparation (optional)	39
1.3 Probe Hybridization	40

## 1.0 Get Started

Items		10x PN	Preparation & Handling	Storage	
<b>Equilibrate to room temperature</b>					
<input type="checkbox"/>	●	Xenium Probe Hybridization Buffer 2000390	Thaw at room temperature for 15 min or until completely thawed. Check for precipitate and invert until clear. Maintain at room temperature after thawing.	-20°C	
<input type="checkbox"/>	●	Xenium Probe Dilution Buffer (to be discontinued) 2000393	Thaw at room temperature. Vortex and centrifuge briefly. Maintain at room temperature after thawing. Use TE Buffer instead of Xenium Probe Dilution Buffer without any impact on assay performance. See details below.	-20°C	
<input type="checkbox"/>	●	Xenium Pre-Designed Gene Expression Probes*	-	Thaw at room temperature. See <a href="#">Probe Hybridization</a> for additional handling instructions.	-20°C
<input type="checkbox"/>	○	Xenium Add-on Custom Probes*	-	Resuspend add-on custom probes according to <a href="#">Custom Probe Preparation</a> . For additional handling instructions, see <a href="#">Probe Hybridization</a> . <i>Xenium v1 assay is not compatible with Xenium Prime add-on custom priming oligos.</i>	-20°C
<input type="checkbox"/>	○	Xenium Standalone Custom Probes*	-	Resuspend standalone custom probes according to <a href="#">Custom Probe Preparation</a> . For additional handling instructions, see <a href="#">Probe Hybridization</a> . <i>Xenium v1 assay is not compatible with Xenium Prime standalone custom priming oligos.</i>	-20°C
<b>Obtain</b>					
<input type="checkbox"/>		Assembled cassettes containing FFPE or FF tissue samples	-	Consult Xenium in Situ for FFPE - Deparaffinization & Decrosslinking (Demonstrated Protocol CG000580) or Xenium in Situ for Fresh Frozen - Fixation & Permeabilization (Demonstrated Protocol CG000581), respectively.	-
<input type="checkbox"/>		Nuclease-free Water	-	-	Ambient
<input type="checkbox"/>		10X PBS, pH 7.4	-	-	Ambient
<input type="checkbox"/>		10% Tween-20	-	-	Ambient
<input type="checkbox"/>		Heatblock or waterbath	-	Preheat to 95°C.	Ambient
<input type="checkbox"/>		Xenium Cassette Lids	3001046	See Tips & Best Practices.	Ambient

Items	10x PN	Preparation & Handling	Storage
(16 ct)			
<input type="checkbox"/> Xenium Thermocycler Adaptor	3000954	See Tips & Best Practices.	Ambient
<input type="checkbox"/> TE Buffer, TRIS-EDTA, 1X Solution, pH 8.0 (nuclease-free)	-	The pH of the stock solution should be 8.0. Readjusting the pH is NOT recommended.	Ambient

\*Thaw appropriate probe panels based on experimental needs. Refer to the 10x Genomics Support Website for the most updated list of available panels and part numbers.



*Pre-heat appropriate equipment to: 37°C & 95°C.*

*Program a thermal cycler with the Probe Hybridization incubation protocol.*

## 1.1 Buffer Preparation

Prepare the following buffers fresh before starting the Xenium In Situ Gene Expression workflow. The volumes of each buffer are sufficient for washes in all subsequent steps.

- a. Prepare 1X PBS according to the table below before use and maintain at **room temperature**. Add reagents in the order listed and mix.

1X PBS	Stock	Final	1X+10% (ml)	2X+10% (ml)
Nuclease-free Water	-	-	13.5	27.0
10X PBS, pH 7.4	10X	1X	1.5	3.0
<b>Total</b>	-	-	<b>15.0</b>	<b>30.0</b>

- b. Using 1X PBS from step 1.1a, prepare PBS-Tween Buffer (PBS-T) according to the table below before use and maintain at **room temperature**. Add reagents in the order listed. Invert gently to mix.

PBS-T	Stock	Final	1X+10% (ml)	2X+10% (ml)
1X PBS (prepared at Step 1.1a)	-	-	9.95	19.9
10% Tween-20	10%	0.05%	0.05	0.1
<b>Total</b>	-	-	<b>10.0</b>	<b>20.0</b>

## 1.2 Custom Probe Preparation (optional)

Proceed to Probe Hybridization, step 1.3, directly if using pre-designed probes only. Add-on and standalone custom probes are delivered lyophilized and must be resuspended before use. Resuspend add-on or standalone custom probes according to the instructions below before proceeding with Probe Hybridization.



*Confirm the number of reactions provided for the add-on or standalone custom probes prior to resuspension.*

- a. Centrifuge custom probe panel tube briefly.
- b. Resuspend lyophilized custom probes in TE Buffer according to the following table.

Custom Probe Resuspension	10x PN	TE Buffer (μl)
<b>4 reactions/kit</b>		
Xenium Add-on	varies	140
Xenium Standalone	varies	140
<b>16 reactions/kit</b>		
Xenium Add-on	varies	700
Xenium Standalone	varies	700

*Xenium Probe Dilution Buffer may be used interchangeably with TE Buffer if sufficient volume is available.*

- c. Replace the cap firmly. Vortex twice for **15 sec** each. Maintain at **room temperature** for **5 min**.
- d. Centrifuge custom probe panel tube briefly and maintain at **room temperature**.
- e. If custom probes are already resuspended, thaw at **room temperature** prior to starting Probe Hybridization.



*Custom probes resuspended in Xenium Probe Dilution Buffer or TE Buffer can be stored at -20°C until the expiration date specified on the kit.*

## 1.3 Probe Hybridization

Before starting this protocol, ensure that tissue sections have been appropriately deparaffinized and decrosslinked if working with FFPE tissues. Ensure that tissue sections have been appropriately fixed and permeabilized if working with fresh frozen tissues. Consult Xenium In Situ for FFPE - Deparaffinization & Decrosslinking Demonstrated Protocol (CG000580) or Xenium In Situ for Fresh Frozen - Fixation & Permeabilization Demonstrated Protocol (CG000581), respectively, for more information.



*During reagent removal steps, ensure that **ALL the liquid is removed** from the wells. See [Reagent Addition to Wells on page 27](#) for guidance.*



*Fluid on the Thermocycler Adaptor may indicate a reagent leak from the cassette. See [Troubleshooting](#) for more details.*

- a. Obtain probes that have been thawed or equilibrated to **room temperature**. Briefly centrifuge the probe tube and remove an aliquot appropriate for the number of desired Xenium slides (**34 µl**/ slide).
- b. Immediately before use, preheat probes by incubating at **95°C** for **2 min** in a heatblock or thermal cycler, followed by **1 min** on **ice**. Maintain on ice.
- c. Prepare Probe Hybridization Mix according to the options below. Preparation instructions for each option can be found on the following page.
  - Pre-designed probe panels only
  - Add-on custom probe panels used with pre-designed probe panels
  - Standalone custom probe panels only

Prepare Probe Hybridization Mix shortly before use and maintain at **room temperature**. Add reagents in the order listed. Pipette mix and centrifuge briefly.

### Option 1: Probe Hybridization Mix (pre-designed probe panels only)

Probe Hybridization Mix (pre-designed probe panels only)		10x PN	1X+5% (µl)	2X+5% (µl)
●	Xenium Probe Hybridization Buffer	2000390	315.0	630.0
	TE Buffer	-	177.0	354.0
●	Xenium Pre-Designed Gene Expression Probes*	-	33.0	66.0
	<b>Total</b>	-	<b>525.0</b>	<b>1,050.0</b>



### Option 2: Probe Hybridization Mix (add-on custom probe panels used with pre-designed probe panels)

Probe Hybridization Mix (add-on custom probe panels used with pre-designed probe panels)		10x PN	1X+5% ( $\mu$ l)	2X+5% ( $\mu$ l)
●	Xenium Probe Hybridization Buffer	2000390	315.0	630.0
	TE Buffer	-	144.0	288.0
●	Xenium Pre-Designed Gene Expression Probes*	varies	33.0	66.0
○	Xenium Add-on Custom Probes**	varies	33.0	66.0
<b>Total</b>		<b>-</b>	<b>525.0</b>	<b>1,050.0</b>

### Option 3: Probe Hybridization Mix (standalone custom probe panels only)

Probe Hybridization Mix (standalone custom probe panels only)		10x PN	1X+5% ( $\mu$ l)	2X+5% ( $\mu$ l)
●	Xenium Probe Hybridization Buffer	2000390	315.0	630.0
	TE Buffer	-	177.0	354.0
○	Xenium Standalone Custom Probes**	varies	33.0	66.0
<b>Total</b>		<b>-</b>	<b>525.0</b>	<b>1,050.0</b>

\*Refer to the 10x Genomics Support Website for the most updated list of available panels and part numbers.

†Custom probes resuspended in Xenium Probe Dilution Buffer or TE Buffer can be stored at -20°C until the expiration date specified on the kit.

*Record the Custom Panel Design ID and Slide Number before starting workflow. This information is critical for identifying the correct electronic decode file when setting up the Xenium Analyzer in downstream steps.*

- d. Prepare a thermal cycler with the following incubation protocol and start the program.

Lid Temperature	Reaction Volume	Run Time
50°C	100 $\mu$ l	-
Step	Temperature	Time hh:mm:ss
Pre-equilibrate	50°C	Hold
Probe Hybridization	50°C	Overnight (16 - 24 h)
Hold	50°C	Hold

- e. Retrieve the assembled Xenium Cassette and remove all the buffer.

- f.** Add **500 µl** room-temperature Probe Hybridization Mix along the side of the well to uniformly cover the tissue sections, without introducing bubbles.
- g.** Apply Xenium Cassette Lid on the cassette and place on the Thermocycler Adaptor on the pre-heated thermal cycler. Tightly close the thermal cycler lid until an audible click is heard.



*Audible click will be heard in thermal cyclers with an adjustable lid (i.e. Bio-Rad C1000 Touch Thermal Cycler).*

- h.** Skip Pre-equilibrate step to initiate Probe Hybridization.
- i.** After Probe Hybridization is complete, proceed to the next step.



# Step 2:

## Post Hybridization Wash

2.0 Get Started	44
2.1 Post Hybridization Wash	45

## 2.0 Get Started

Items		10x PN	Preparation & Handling	Storage	
<b>Equilibrate to room temperature</b>					
<input type="checkbox"/>	<input type="radio"/>	Xenium Post Hybridization Wash Buffer	2000395	Thaw at room temperature for 30 min or until thawed completely. Vortex and centrifuge briefly. Keep the buffer at room temperature after thawing.	-20°C
<b>Obtain</b>					
<input type="checkbox"/>		PBS-T	-	Prepared at Step 1.1.	Ambient



*Program a thermal cycler with Post Hybridization Wash incubation protocol.*

## 2.1 Post Hybridization Wash

- a. Remove the Xenium Cassette from the Thermocycler Adaptor and place on a flat, clean work surface.



*DO NOT let the cassette cool down before proceeding to PBS-T washes.*



*DO NOT proceed with assay if slide is cracked or broken. Cracked or broken slides will result in assay failure.*



*Fluid on the Thermocycler Adaptor may indicate a reagent leak from the cassette. See [Troubleshooting](#) for more details.*

- b. Remove the Xenium Cassette Lid. Using a pipette, remove all Probe Hybridization Mix from well corners. Discard old Cassette Lids.

- c. Using a pipette, remove all the buffer from well corners.

*If processing two slides at a time, remove and add reagent from first slide before proceeding to second slide. Ensure tissue sections are always covered with reagent in between removal and addition steps to avoid drying out of tissue samples. At least 400  $\mu$ l of liquid should be aspirated from each slide.*

**Two PBS-T washes** (PBS-T prepared at step 1.1):

- d. **Wash 1: Immediately add 500  $\mu$ l.** Incubate for **1 min** at **room temperature**. Remove all PBS-T.
- e. **Wash 2: Add 500  $\mu$ l PBS-T.** Incubate for **1 min** at **room temperature**.
- f. Prepare a thermal cycler with the following incubation protocol and start the protocol.

Lid Temperature	Reaction Volume	Run Time
37°C (lid may be set to the lowest temperature if the instrument does not enable 37°C)	100 $\mu$ l	-

Step	Temperature	Time hh:mm:ss
Pre-equilibrate	37°C	Hold
Post Hybridization Wash	37°C	00:30:00
Hold	37°C	Hold

- g. Remove all PBS-T to complete wash 2.
- h. Add **500  $\mu$ l** Xenium Post Hybridization Wash Buffer to the well.

- i. Apply a new Xenium Cassette Lid on the cassette and place on the Thermocycler Adaptor on the pre-heated thermal cycler. Close the thermal cycler lid.
- j. Skip Pre-equilibrate step to initiate Post Hybridization Wash.



*Start thawing Ligation reagents during Post Hybridization Wash incubation as outlined in [Get Started on page 48](#).*

- k. After the Post Hybridization Wash is complete, **immediately** proceed to the next step.

# Step 3:

## Ligation

3.0 Get Started

48

3.1 Ligation

49

## 3.0 Get Started

Items		10x PN	Preparation & Handling	Storage	
<b>Equilibrate to room temperature</b>					
<input type="checkbox"/>	●	Xenium Ligation Buffer	2000391	Thaw at room temperature for 15 min or until completely thawed. Pipette MIX and centrifuge briefly. Maintain at room temperature after thawing.	-20°C
<b>Place on ice</b>					
<input type="checkbox"/>	●	Xenium Ligation Enzyme A	2000397	Pipette mix and centrifuge briefly. Maintain on ice until ready to use.	-20°C
<input type="checkbox"/>	●	Xenium Ligation Enzyme B	2000398	Pipette mix and centrifuge briefly. Maintain on ice until ready to use.	-20°C
<b>Obtain</b>					
<input type="checkbox"/>		PBS-T	-	Prepared at Step 1.1.	Ambient





*Program a thermal cycler with Ligation incubation protocol.*



## 3.1 Ligation

- a. Prepare Ligation Mix shortly before using. Add reagents in the order listed. Pipette mix 10X and centrifuge briefly. Maintain on ice.

Ligation Mix	10x PN	1X+10% ( $\mu$ l)	2X+10% ( $\mu$ l)
 Xenium Ligation Buffer	2000391	481.2	962.5
 Xenium Ligation Enzyme A	2000397	13.8	27.5
 Xenium Ligation Enzyme B	2000398	55.0	110.0
<b>Total</b>	-	<b>550.0</b>	<b>1,100.0</b>

- b. Remove the Xenium Cassette from the Thermocycler Adaptor and place on a flat, clean work surface.
- c. Remove the Xenium Cassette Lid. Using a pipette, remove all Xenium Post Hybridization Wash Buffer from the well. Discard used cassette lids.



*If processing two slides at a time, remove and add reagent from first slide before proceeding to second slide. Ensure tissue sections are always covered with reagent in between removal and addition steps to avoid drying out of tissue samples. At least 400  $\mu$ l of liquid should be aspirated from each slide.*

**Three PBS-T washes** (PBS-T prepared at step 1.1):

- d. **Wash 1: Immediately add 500  $\mu$ l PBS-T. Incubate for 1 min at room temperature.** Remove all PBS-T.
- e. **Wash 2: Add 500  $\mu$ l PBS-T. Incubate for 1 min at room temperature.** Remove all PBS-T.
- f. **Wash 3: Add 500  $\mu$ l PBS-T. Incubate for 1 min at room temperature.**
- g. Prepare a thermal cycler with the following incubation protocol. Place a Thermocycler Adaptor on the thermal cycler and start the program.

Lid Temperature	Reaction Volume	Run Tie
37°C (lid may be set to the lowest temperature if the instrument does not enable 37°C)	100 $\mu$ l	-

Step	Temperature	Time hh:mm:ss
Pre-equilibrate	37°C	Hold
Ligation	37°C	02:00:00
Hold	37°C	Hold

- h.** Remove all PBS-T to complete wash 3.
- i.** Add **500 µl** Ligation Mix to the well.
- j.** Apply a new Xenium Cassette Lid on the cassette and place on the Thermocycler Adaptor on the pre-heated thermal cycler. Close the thermal cycler lid.
- k.** Skip Pre-equilibrate step to initiate Ligation.



*Start thawing Amplification reagents (except enzymes) during Ligation incubation as outlined in [Get Started on page 52](#).*

- l.** After Ligation is complete, **immediately** proceed to next step.





# Step 4:

## Amplification

4.0 Get Started	52
4.1 Amplification	53
4.2 Post Amplification Wash	55

## 4.0 Get Started

Item		10x PN	Preparation & Handling	Storage	
<b>Place on ice</b>					
<input type="checkbox"/>		Xenium Amplification Mix	2000392	Immediately after initiating Ligation step, thaw on ice. Vortex and centrifuge briefly. Ensure completely thawed before use, with no precipitate remaining.	-20°C
<input type="checkbox"/>		Xenium Amplification Enzyme	2000399	Transfer to ice before use. Pipette mix and centrifuge briefly. Maintain on ice until ready to use.	-20°C
<b>Obtain</b>					
<input type="checkbox"/>		PBS-T	-	Prepared at Step 1.1.	Ambient
<input type="checkbox"/>		TE Buffer, TRIS-EDTA, 1X Solution, pH 8.0 (nuclease-free)	-	-	Ambient

## 4.1 Amplification

- a. Prepare Amplification Master Mix on ice shortly before use. Add reagents in the order listed. Pipette mix 10X and centrifuge briefly. Maintain on ice.

Amplification Master Mix	10x PN	1X +10% (µl)	2X +10% (µl)
● Xenium Amplification Mix (Thaw, vortex, centrifuge briefly before use)	2000392	495.0	990.0
● Xenium Amplification Enzyme	2000399	55.0	110.0
<b>Total</b>	-	<b>550.0</b>	<b>1,100.0</b>

- b. Remove the Xenium Cassette from the Thermocycler Adaptor and place on a flat, clean work surface.
- c. Remove the Xenium Cassette Lid. Using a pipette, remove all the buffer from the well. Discard used cassette lids.

*If processing two slides at a time, remove and add reagent from first slide before proceeding to second slide. Ensure tissue sections are always covered with reagent in between removal and addition steps to avoid drying out of tissue samples. At least 400 µl of liquid should be aspirated from each slide.*

**Three PBS-T washes** (PBS-T prepared in step 1.1):

- d. **Wash 1: Immediately** add **500 µl** PBS-T. Incubate for **1 min** at **room temperature**. Remove all PBS-T.
- e. **Wash 2: Immediately** add **500 µl** PBS-T. Incubate for **1 min** at **room temperature**. Remove all PBS-T.
- f. **Wash 3: Immediately** add **500 µl** PBS-T. Incubate for **1 min** at **room temperature**.
- g. Prepare a thermal cycler with the following incubation protocol. Place a Thermocycler Adaptor on the thermal cycler and start the program.

Lid Temperature	Reaction Volume	Run Time
30°C (lid may be set to the lowest temperature if the instrument does not enable 30°C)	100 µl	-

Step	Temperature	Time hh:mm:ss
Pre-equilibrate	30°C	Hold
Amplification	30°C	02:00:00

- h.** Remove all PBS-T to complete wash 3.
- i. Immediately** add **500 µl** Amplification Master Mix to the well.
- j.** Apply a new Xenium Cassette Lid on the Xenium Cassette and place on the Thermocycler Adaptor on the thermal cycler. Close the thermal cycler lid.
- k.** Skip pre-equilibrate step to initiate Amplification.



*Start thawing Autofluorescence Quenching reagents during Amplification incubation as outlined in [Get Started on page 57](#). DO NOT add the ethanol until right before use.*

- l.** After Amplification is complete, **immediately** proceed to the next step.

## 4.2 Post Amplification Wash

- a. Remove the Xenium Cassette from the Thermocycler Adaptor and place on a flat, clean work surface.
- b. Remove the Xenium Cassette Lid. Using a pipette, remove all Amplification Mix from the well. Discard old Cassette Lids.

### Three TE Washes:

- c. **Wash 1:** Add **500 µl** TE Buffer to the well. Incubate **1 min** at **room temperature**. Remove all TE buffer.
- d. **Wash 2:** Add **500 µl** TE Buffer to the well. Incubate **1 min** at **room temperature**. Remove all TE buffer.
- e. **Wash 3:** Add **500 µl** TE Buffer to the well (buffer removal will be in next step to complete wash 3).
- f. Proceed to the next step.

# Step 5:

## Autofluorescence Quenching

5.0 Get Started	57
5.1 Autofluorescence Quenching	58
5.2 Nuclei Staining	61



## 5.0 Get Started

Items		10x PN	Preparation & Handling	Storage	
<b>Equilibrate to room temperature</b>					
<input type="checkbox"/>	●	Xenium Autofluorescence Mix	2000753	Thaw in a thermomixer (with 2.0-ml thermoblock) for 15 min at 37°C, 300 rpm with shaking. Cool to room temperature for 5 min. Vortex for 30 sec and centrifuge briefly.  Alternatively, thaw in a waterbath for 15 min at 37°C. Cool to room temperature for 5 min. Vortex for 30 sec and centrifuge briefly.*	-20°C
<input type="checkbox"/>	○	Reducing Agent B	2000087	Thaw at room temperature. Vortex and centrifuge briefly.	-20°C
<input type="checkbox"/>	●	Xenium Nuclei Staining Buffer	2000762	Thaw at room temperature. Vortex and centrifuge briefly. Keep in the dark until ready to use.	-20°C
<b>Obtain</b>					
<input type="checkbox"/>		Nuclease-free Water	-	-	Ambient
<input type="checkbox"/>		1X PBS	-	Prepared at Step 1.1.	Ambient
<input type="checkbox"/>		PBS-T	-	Prepared at Step 1.1.	Ambient
<input type="checkbox"/>		100% Ethanol	-	-	Ambient

\*If processing only one slide, remove the volume required (specified in the following section), and refreeze the remaining reagent in the tube at -20°C.



*Pre-heat appropriate equipment to: 37°C.*

*100% ethanol is needed for washes in addition to making 70% ethanol dilutions.*

## 5.1 Autofluorescence Quenching

a. Prepare the following for Autofluorescence Quenching:

i. **Prepare diluted Reducing Agent B.** Add reagents in the order listed and vortex to mix. Maintain at room temperature.

	Diluted Reducing Agent B	10x PN	Stock	Final	1X+10% (μl)	2X+10% (μl)
	1X PBS (prepared at Step 1.1)	-	-	-	544.5	1,089.0
○	Reducing Agent B	2000087	-	-	5.5	11.0
	<b>Total</b>	-	-	-	<b>550.0</b>	<b>1,100.0</b>

ii. **Prepare 70% ethanol.** Add reagents in the order listed and vortex to mix. Maintain at room temperature.

	70% Ethanol	10x PN	Stock	Final	1X+10% (μl)	2X+10% (μl)
	Nuclease-free Water	-	-	-	330.0	660.0
	100% Ethanol	-	100%	70%	770.0	1,540.0
	<b>Total</b>	-	-	-	<b>1,100.0</b>	<b>2,200.0</b>

iii. **Prepare Autofluorescence Solution using thawed Xenium Autofluorescence Mix prepared according to step 5.0.** Add reagents in the order listed and vortex to mix. Maintain at room temperature in the dark until ready to use.

*If processing only one slide, remove the Xenium Autofluorescence Mix volume required for 1X+10% (specified in the table below), and refreeze the remaining reagent at -20°C. Once diluted with ethanol, the Xenium Autofluorescence Mix should not be refrozen.*

	Autofluorescence Solution	10x PN	Stock	Final	1X+10% (μl)	2X+10% (μl)
	100% Ethanol	-	100%	-	544.5	1,089.0
●	Xenium Autofluorescence Mix	2000753	-	-	5.5	11.0
	<b>Total</b>	-	-	-	<b>550.0</b>	<b>1,100.0</b>

b. Retrieve the Xenium Cassette from step 4.2 and place on a flat, clean work surface.

c. Using a pipette, remove all TE Buffer from the well.

*If processing two slides at a time, remove and add reagent from first slide before proceeding to second slide. Ensure tissue sections are always covered with reagent in between removal and addition steps to avoid drying out of tissue samples. At least 400 µl of liquid should be aspirated from each slide.*

**Three PBS Washes:**

- d. Wash 1:** Add **1,000 µl** 1X PBS prepared at step 1.1 to the well and incubate for **1 min** at **room temperature**. Remove all 1X PBS.
- e. Wash 2:** Add **1,000 µl** 1X PBS prepared at step 1.1 to the well and incubate for **1 min** at **room temperature**. Remove all 1X PBS.
- f. Wash 3:** Add **1,000 µl** 1X PBS prepared at step 1.1 to the well and incubate for **1 min** at **room temperature**. Remove all 1X PBS.
- g.** Add **500 µl** Diluted Reducing Agent B prepared at step 5.1ai to the well.
- h.** Apply a new Xenium Cassette Lid on the cassette, and incubate for **10 min** at **room temperature**.
- i.** Remove the Xenium Cassette Lid. Using a pipette, remove all Diluted Reducing Agent B from the well. **Save the lid** for use in following indicated steps.

**Three ethanol washes:**

- j. Wash 1:** Add **1,000 µl** 70% ethanol. Incubate for **1 min** at **room temperature**. Remove the ethanol.
- k. Wash 2:** Add **1,000 µl** 100% ethanol. Incubate for **1 min** at **room temperature**. Remove the ethanol.
- l. Wash 3:** Add **1,000 µl** 100% ethanol. Incubate for **1 min** at **room temperature**. Remove the ethanol.
- m.** Pipette mix Autofluorescence Solution prepared at step 5.1aiii thoroughly before dispensing onto sample to prevent settling of reagent. Add **500 µl** Autofluorescence Solution to the well.
- n.** Reapply Xenium Cassette Lid on the cassette, and incubate for **10 min** at **room temperature in the dark**.
- o.** Prepare a thermal cycler with the following incubation protocol. Place a Thermocycler Adaptor on the thermal cycler and start the program.

Lid Temperature	Reaction Volume	Run Time
37°C (lid may be set to the lowest temperature if the instrument does not enable 37°C)	100 µl	-
Step	Temperature	Time hh:mm:ss
Pre-equilibrate	37°C	Hold
Drying	37°C	00:05:00

- p. Remove the Xenium Cassette Lid. Using a pipette, remove all the buffer. Discard old Cassette Lids.

### Three ethanol washes:



**Ethanol washes DO NOT need to be performed in the dark.**

- q. **Wash 1:** Add **1,000 µl 100%** ethanol. Incubate for **2 min** at **room temperature**. Remove the ethanol.
- r. **Wash 2:** Add **1,000 µl 100%** ethanol. Incubate for **2 min** at **room temperature**. Remove the ethanol.
- s. **Wash 3:** Add **1,000 µl 100%** ethanol. Incubate for **2 min** at **room temperature**. Remove the ethanol.
- t. Place Xenium Cassette **without lid** on the Thermocycler Adaptor on the thermal cycler to dry. **DO NOT** close the thermal cycler lid.
- u. Skip pre-equilibrate step to initiate Drying.
- v. **Immediately** remove the cassette from the Thermocycler Adaptor and place on a flat, clean work surface.
- w. Add **1,000 µl 1X PBS** prepared at step 1.1 to rehydrate the tissue and incubate for **1 min** at **room temperature in the dark**.
- x. Remove all 1X PBS.
- y. Add **1,000 µl PBS-T** and incubate for **2 min** at **room temperature in the dark**.



*Optional: photograph the slide against a white background. This image can be used for comparison purposes to identify tissue detachment downstream in the workflow. See [Troubleshooting](#) for more details.*



- z. Store slides **16-24 h** (overnight) at **4°C in the dark** with a Xenium Cassette Lid applied on the Xenium Cassette. If storing slides, **DO NOT** discard the lid; instead save for Step 5.2 Nuclei Staining. Alternatively, proceed to the next step.

## 5.2 Nuclei Staining

- a. Retrieve thawed Xenium Nuclei Staining Buffer prepared as outlined in [5.0 Get Started on page 57](#).
- b. Retrieve the Xenium Cassette from the previous step 5.1ab and place on a flat, clean work surface.
- c. If stored, remove the Xenium Cassette Lid . Using a pipette, remove all PBS-T from the well. **Save the lid** for use in following indicated steps.
- d. Add **500 µl** Xenium Nuclei Staining Buffer and incubate **1 min at room temperature in the dark**.
- e. Remove all Nuclei Staining Buffer.  
**Three PBS-T washes** (PBS-T prepared at step 1.1):
  - f. **Wash 1:** Add **1,000 µl** PBS-T. Incubate for **1 min at room temperature in the dark**. Remove all PBS-T.
  - g. **Wash 2:** Add **1,000 µl** PBS-T. Incubate for **1 min at room temperature in the dark**. Remove all PBS-T.
  - h. **Wash 3:** Add **1,000 µl** PBS-T. Incubate for **1 min at room temperature in the dark**. Remove all PBS-T
  - i. Add **1,000 µl** PBS-T.
  - j. Store slides (as specified below) or alternatively, proceed directly to the Xenium Analyzer User Guide (CG000584).



*Slides from different Xenium assay workflows cannot be run together on the same instrument run.*

Short-term storage for **≤1 week at 4°C in the dark** with a Xenium Cassette Lid applied on the cassette.



*Ensure that the slide is stored in microbe-free and nuclease-free conditions, with a Xenium Cassette Lid applied to prevent evaporation. Storing slides for more than recommended time risks decrease in sensitivity. These risks are dependent on many factors, including input tissue quality and how nuclease-free and microbe-free the workflow is.*

Long-term storage for **(1 week – 2 months)** at **-20°C**. Perform serial ethanol washes to dehydrate, transfer the slide to a mailer, and store in **10 ml** cryoprotectant (30% Glycerol prepared in PBS), as described in [Xenium Cassette Storage on page 29](#)



*Storing slides for more than one month risks ~5% decrease in sensitivity.*

*These risks are dependent on many factors, including input tissue quality and how nuclease-free and microbe-free the workflow is.*

The above storage guidelines can also be used for storing Xenium cassettes with slides after Xenium Analyzer run (or in the event of a run failure). Contact [support@10xgenomics.com](mailto:support@10xgenomics.com) for more information.

# Troubleshooting



## Tissue Detachment and Folding

Tissue detachment may result in a lack of decodable data in the region where detachment occurred. If the tissue has folded on itself, this may also cause elevated signal in the overlapping areas. Inspect images carefully to identify these areas. If tissue detachment is observed during this workflow, contact [support@10xgenomics.com](mailto:support@10xgenomics.com)

### Tissue Detachment in Human Breast as viewed on Xenium Analyzer Overview Scan

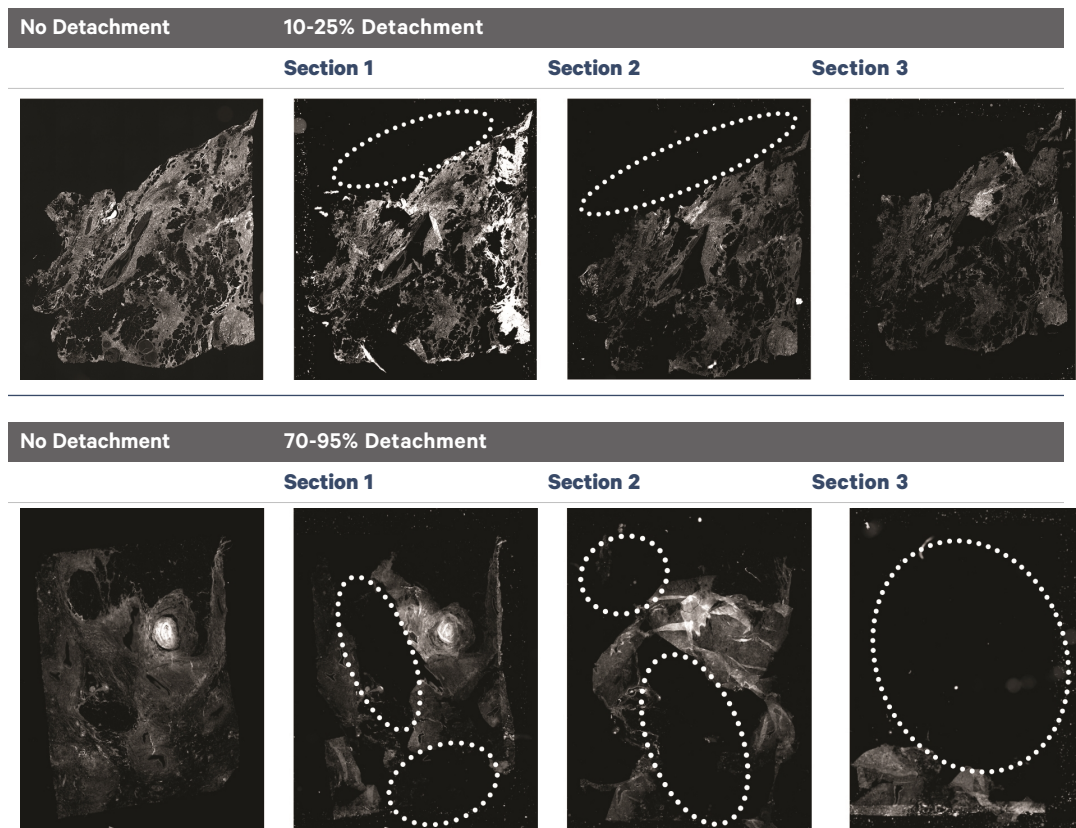

*Percentages represent tissue detachment/"area that cannot be analyzed" at the end of the Xenium Analyzer workflow. White circles indicate areas of tissue detachment.*



## Tissue Detachment on Xenium Slides

Tissue sections may detach from Xenium slides during on-slide workflows. Tissue adhesion to the slide is impacted both by tissue processing and tissue quality.

Careful tissue preparation is critical for adhesion in on-slide workflows. Consult Xenium In Situ for Fresh Frozen - Tissue Preparation Guide (Document CG000578) and Xenium In Situ for FFPE - Tissue Preparation Guide (Document CG000579) for tissue QC and sectioning best practices. Below are some additional best practices for minimizing detachment during on-slide workflows:

- Do not pipette directly onto the tissue.
- Gently add and remove reagents from the well. Forceful addition or removal of reagents can agitate tissue and lead to detachment.
- Avoid touching in and around the Sample Area of the Xenium slide.
- Work quickly and carefully during reagent addition and removal.

In addition to following best practices, it is possible to monitor section adhesion on Xenium slides throughout the workflow. Taking a photograph of the slide at the beginning of the on-slide workflow and comparing with post-assay workflow images can help identify whether tissue shape has changed significantly, an indication of detachment. Steps when slide photos can be taken are noted in the protocol. These QC images can be compared with the DAPI overview scan as part of the Web Summary file to see whether tissue morphology has changed in the workflow.

If tissue detachment occurs, send pictures to [support@10xgenomics.com](mailto:support@10xgenomics.com) for further assistance.

## Bubbles during Workflow

Bubbles may occur throughout the workflow, including during PBS-T washes. Bubbles floating on the surface of the slide are unlikely to compromise assay performance. However, bubbles that are in contact with the tissue during a Xenium Analyzer run may result in a lack of decodable data in the tissue area where the bubbles occurred.

Avoid generating bubbles during reagent dispensing by pipetting slowly and avoiding expelling air from the pipette tip. Gently tap or rock the cassette after reagent dispensation and inspect the cassette carefully to ensure liquid is fully covering the tissue. DO NOT aspirate or pop the bubbles as this could lead to tissue detachment or scratching of the tissue. Ensure there are no bubbles on the assembled cassette before loading it into the Xenium Analyzer.

## Number of Washes

Post Hybridization and post-Ligation washes are critical for assay performance. Failure to perform the correct number of washes can reduce the fraction of usable decodable data. A similar effect is observed when washing for less than the recommended time, or when reagent is carried over during the washes. Remove all liquid from the well when washing, and refer to User Guide for correct number of washes and incubation times.

## Samples Dry Out

Drying of tissue samples may lead to decreased decoding efficiency and unusable data and will impact overall assay performance and sensitivity. Work quickly and ensure reagents are dispensed evenly across tissues during incubation and wash steps throughout the workflow to prevent drying out of tissues. If processing two slides at a time, remove and add reagent from first slide before proceeding to second slide. Ensure tissue sections are always covered with reagent in between removal and addition steps. Note that there are no safe stopping points except for those described in the protocol and outlined specifically in the [Protocol Steps & Timing on page 15](#).

## Cassette Assembly Failure

Incorrect assembly of the Xenium cassettes with a Xenium slide can negatively impact assay performance. Always dry the front and the back of the slide completely using a lint-free laboratory wipe while avoiding touching or damaging of the tissue sections. Inspect the slide carefully to ensure it is seated fully within the cassette before assembly.

Example scenarios that may indicate incorrect Xenium Cassette assembly are described below:

- If a gap appears between the two halves of the cassette after assembly.
- If the cassette does not click shut or appears domed after assembly.
- For Xenium Cassette v2, slide is not placed underneath the slide clip.
- If the Xenium Thermocycler Adaptor is wet following removal from the thermal cycler, indicating reagent leakage from the cassette.

If the cassette is incorrectly assembled, disassemble and reassemble the cassette as instructed in the following pages.



*Inspect gasket during cassette assembly. Damaged gaskets can lead to leaks in the cassette.*

## Xenium Cassette Assembly



Exercise caution when handling slide edges to prevent injury.

- 1 Place top and bottom halves of cassette on bench with the top cassette facing down and bottom cassette facing up.

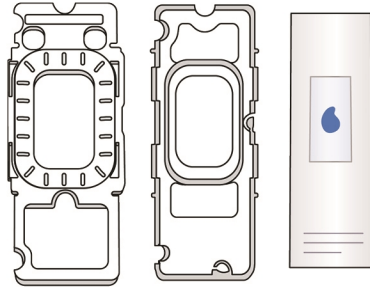

- 2 Place Xenium slide with tissue side facing upwards into bottom half of cassette; ensure label is toward bottom of cassette.

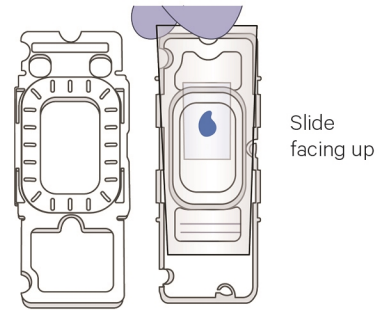

- 3 Press slide down into grooves of the bottom half of the cassette until it sits firmly in place.

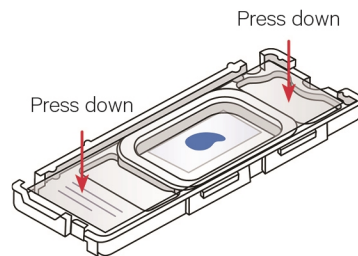

- 4 Secure clips of top half with tabs of bottom half (on both sides).

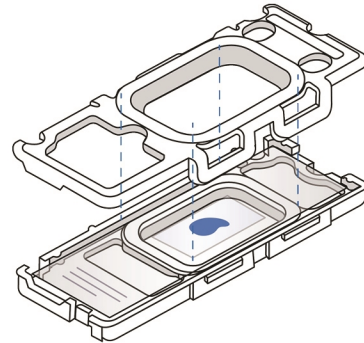

- 5 Apply even pressure on top of cassette until all clips click shut. Verify that clips are completely secured over tabs.

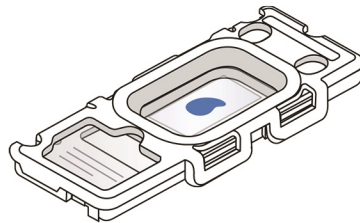

### TIPS

Once cassette is assembled, DO NOT remove slide until after Xenium Analyzer imaging and decoding for optional H&E staining step.

## Xenium Cassette Removal



Exercise caution when handling slide edges to prevent injury.

- 1** Pull inner clips from inner tabs to detach top and bottom halves of cassette.

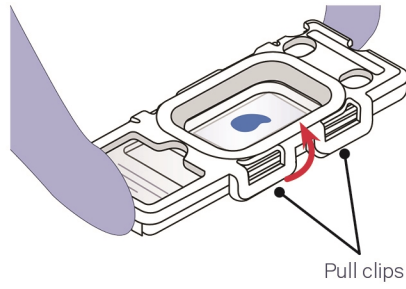

- 2** Open cassette by continuing to lift inner clips upward.

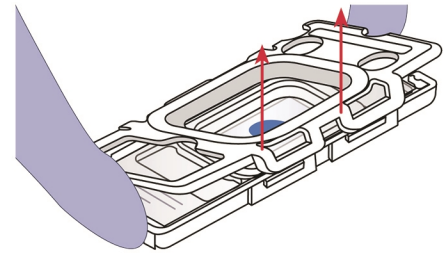

- 3** Hold slide by the label and lift slide out from bottom half.

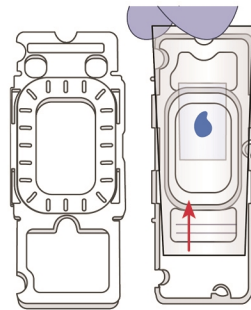

## Xenium Cassette and Lid Cleaning

Xenium Cassettes and Lids are single use items and are to be discarded after use (unless specified in the protocol step that the lid should be saved and reused). Cassettes (prior to cassette assembly) or lids that are accidentally dropped may be reused after thorough cleaning. Note that PBS-T washes DO NOT require sealing of the cassette.

### **Cleaning Procedure:**

- Rinse the lid under running Milli-Q Water
- Spray with 70% isopropanol
- Rinse under running Milli-Q Water
- Spray with 70% isopropanol a second time
- Rinse under running Milli-Q Water
- Air dry

## Incorrect Autofluorescence Quenching

Variation in stain color is normal and tissue-type dependent in tissue sections correctly stained with Autofluorescence Solution. Incorrect staining scenarios are listed below:

- Uneven staining with Autofluorescence Solution may be visible as a non-uniform stain across a tissue section.
- Overquenching can cause tissue to overheat on the Xenium Analyzer, and data generated in the overheated spots may be compromised or missing.

Improper Autofluorescence Quenching risks lower transcript quality scores and reduced median transcripts per cell, but depends on the sample type. Underquenching is lower risk than overquenching.

Ensure Autofluorescence Solution is well mixed and dispensed uniformly across the tissue sections to avoid uneven staining. Autofluorescence Quenching has been optimized for a large number of tissue types and modifying the dilution listed in the User Guide is not recommended. Cassette should be sealed properly and firmly during incubation to prevent reagent evaporation.

**Incorrect or insufficient Autofluorescence Quenching may cause variation in staining of tissues (mouse brain pictured below)**

**Unstained**



**Normally Stained**



**Overstained**

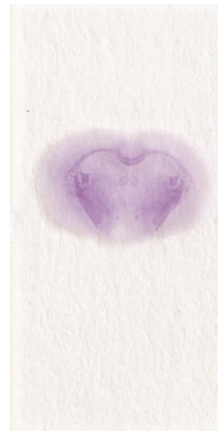

**Understained**



## Incorrect Nuclei Staining

Incorrect staining of nuclei may lead to poor image quality and an inability to easily identify tissue or regions of interest when selecting areas to image during a Xenium Analyzer overview scan. Follow the Nuclei Staining protocol as instructed using the Xenium Nuclei Staining Buffer provided in the Xenium Slides & Sample Prep Reagents Kit - (2 slides, 2 rxns), PN-1000460. Confirm Xenium Nuclei Staining Buffer is well mixed and applied uniformly across tissue sections. All incubations with Xenium Nuclei Staining Buffer should be performed in the dark. If an alternate staining protocol or buffer is used, lower quality images may be obtained.

Incorrect or insufficient nuclei staining may impact image quality and region of interest selection (as viewed on a Xenium Analyzer overview scan)

**Correct Nuclei Staining Protocol**

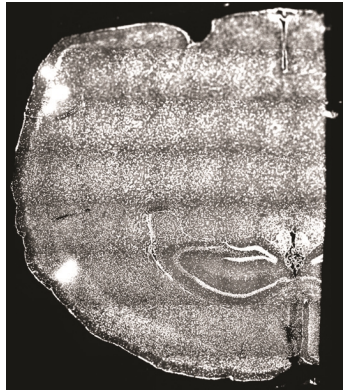

**No Nuclei Staining Performed**

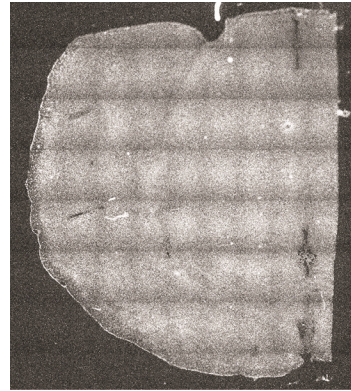





# Appendix

Probe Panel Selection

74

Sample Shipping

74

## Probe Panel Selection

Ensure that a compatible gene panel has been selected prior to executing the Xenium In Situ Gene Expression workflow. 10x Genomics provides the option of using pre-designed gene panels, pre-designed panels that are customized by adding genes of interest, and standalone custom gene panels.

### Pre-designed Gene Panels

Refer to the 10x Genomics Support Website for the most current list of available panels and part numbers.

### Custom Gene Panels

Contact your 10x Genomics Sales Executive for information about designing a standalone custom gene panel or add-on custom gene panels that are compatible with pre-designed panels. If you do not know your Sales Executive, please contact [customerservice@10xgenomics.com](mailto:customerservice@10xgenomics.com).

If utilizing a custom panel, the Design ID on the label of the tube containing the custom panel should match with the first portion of the custom gene panel electronic file name.

## Sample Shipping

Processed Xenium slides may be shipped within 1 week of completing the Xenium In Situ assay workflow. After Nuclei Staining, remove all PBS-T, disassemble the Xenium Cassette, and place no more than two slides in a mailer. Ship using one of the two options:

- Fill the mailer (containing the slides) to capacity with PBS-T, place the mailer in a container with ice packs, and ship (overnight to 2 days).
- Dehydrate the slides by serial ethanol washes as described on [Xenium Cassette Storage on page 29](#). Fill the mailer (containing the slides) to capacity with a cryoprotectant (30% Glycerol), place the mailer in a container with dry ice, and ship (overnight to 2 days).

Note that assay performance may be compromised post-shipping and handling.